

# 3

## Инструкция по сборке

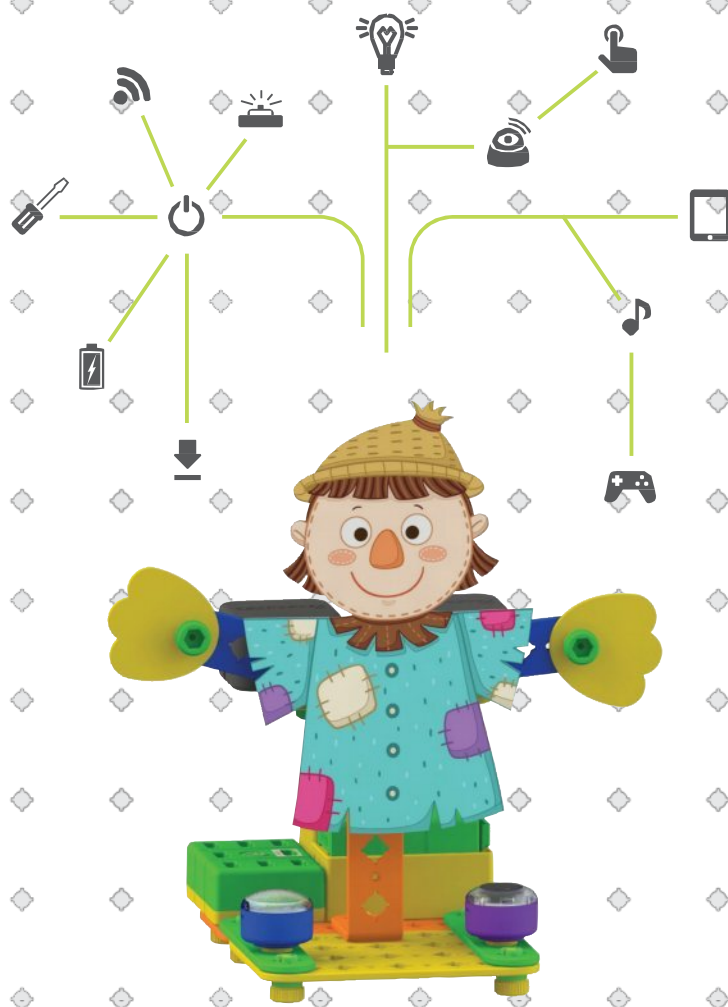

# Udaro

ПРОГРАММИРОВАНИЕ РОБОТА

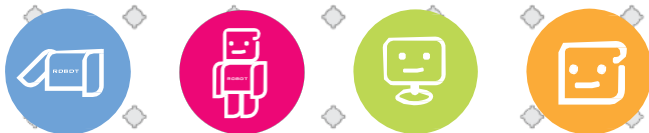





**ПРОГРАММИРОВАНИЕ РОБОТА**

Мир интерактивного программирования

# Меры предосторожности



Запрещается брать детали в рот



Запрещается бросать детали в других



Запрещается бросать детали в воду



Беречь детали от огня



Сборку разрешается выполнять под руководством



После работы необходимо убрать рабочее место





## Инфракрасный датчик

Инфракрасный датчик обнаруживает присутствие объектов. Активировать датчик можно, поместив над ним руку или объект.

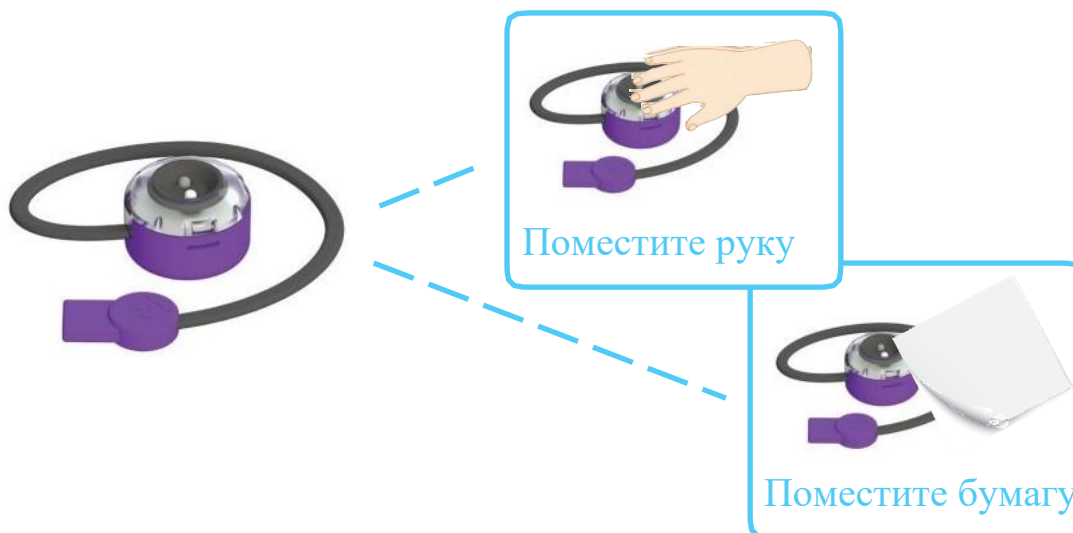

## Программная плата и программные блоки

Программная плата используется для программирования движений робота. Программные блоки используются совместно с программной платой. В блоках запрограммированы различные действия.



Программная плата



Программный блок



## Как использовать программную плату

Изучим процесс программирования и эксплуатации робота с помощью программной платы.

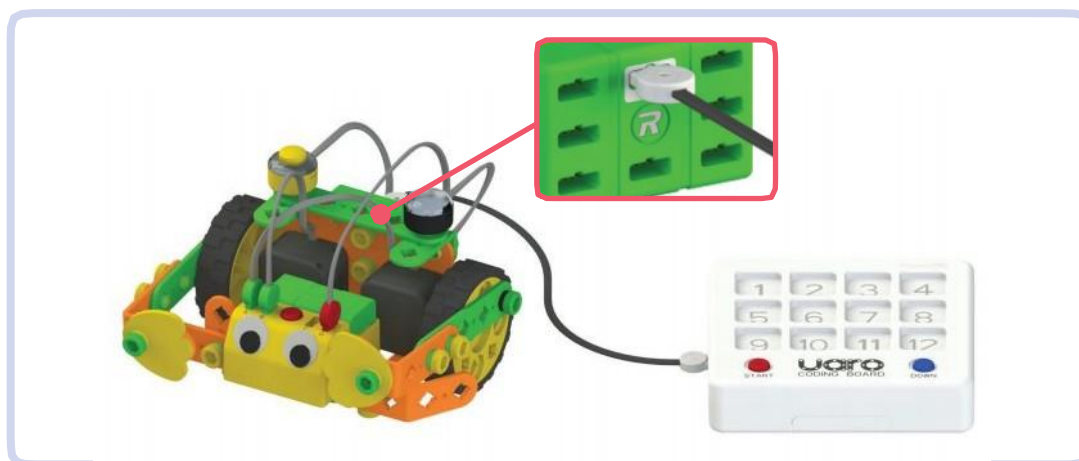

- 1 Подключите программную плату к роботу с помощью программного кабеля. (Используйте порт «DOWN» на ЦП)



- 2 Включите робота и программную плату.



## Как использовать программную плату



- 3 Используя контактный датчик, измените цвет LED экрана ЦП на белый.



- 4 Установите программный блок на программную плату. В этом заключается процесс программирования! Нажмите на синюю кнопку, чтобы загрузить действие программного блока в ЦП. (В данном примере используется блок беспроводного дистанционного управления)





## Как использовать программную плату



5 Отсоедините программный кабель.

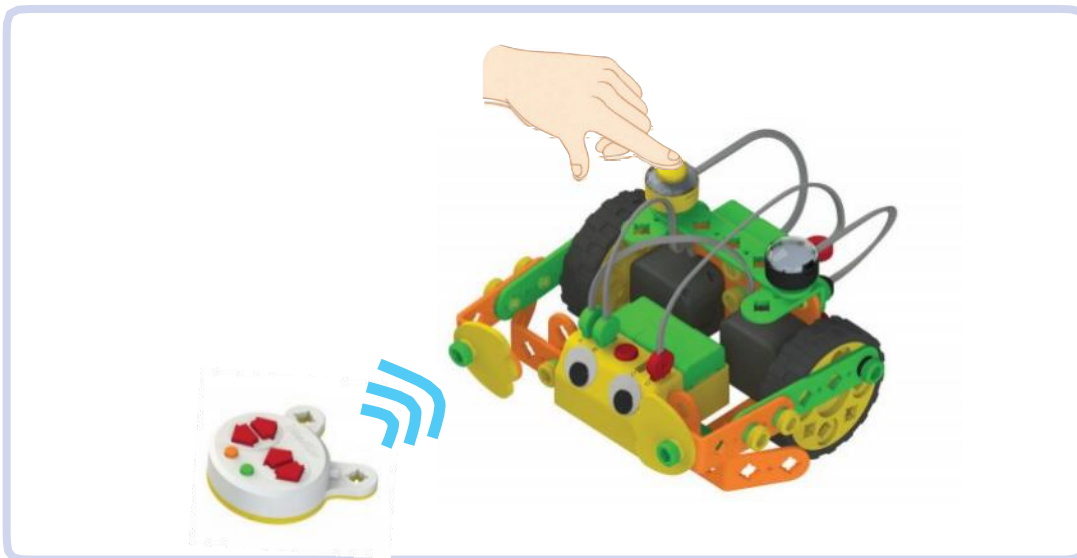

6 Нажмите на контактный датчик робота, чтобы робот начал работать. Теперь вы можете управлять роботом дистанционно!

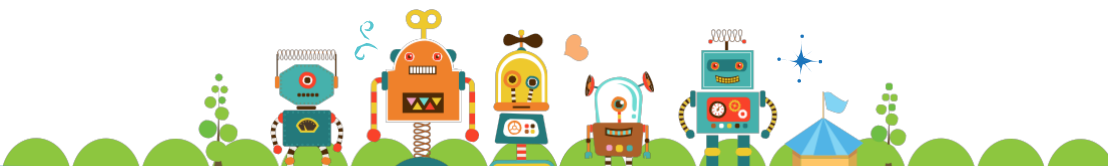



Сыграем с роботом для реслинга





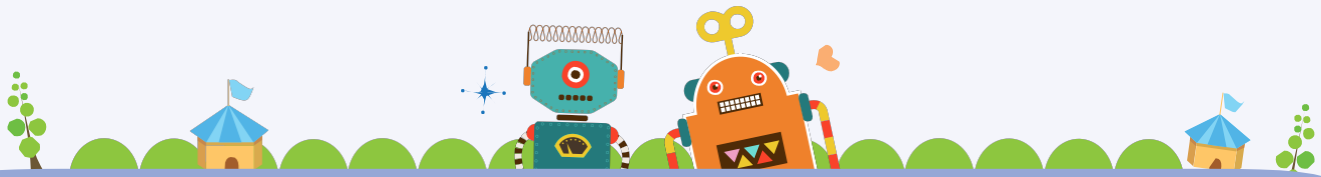

Детали



x1



x1



x2



x2

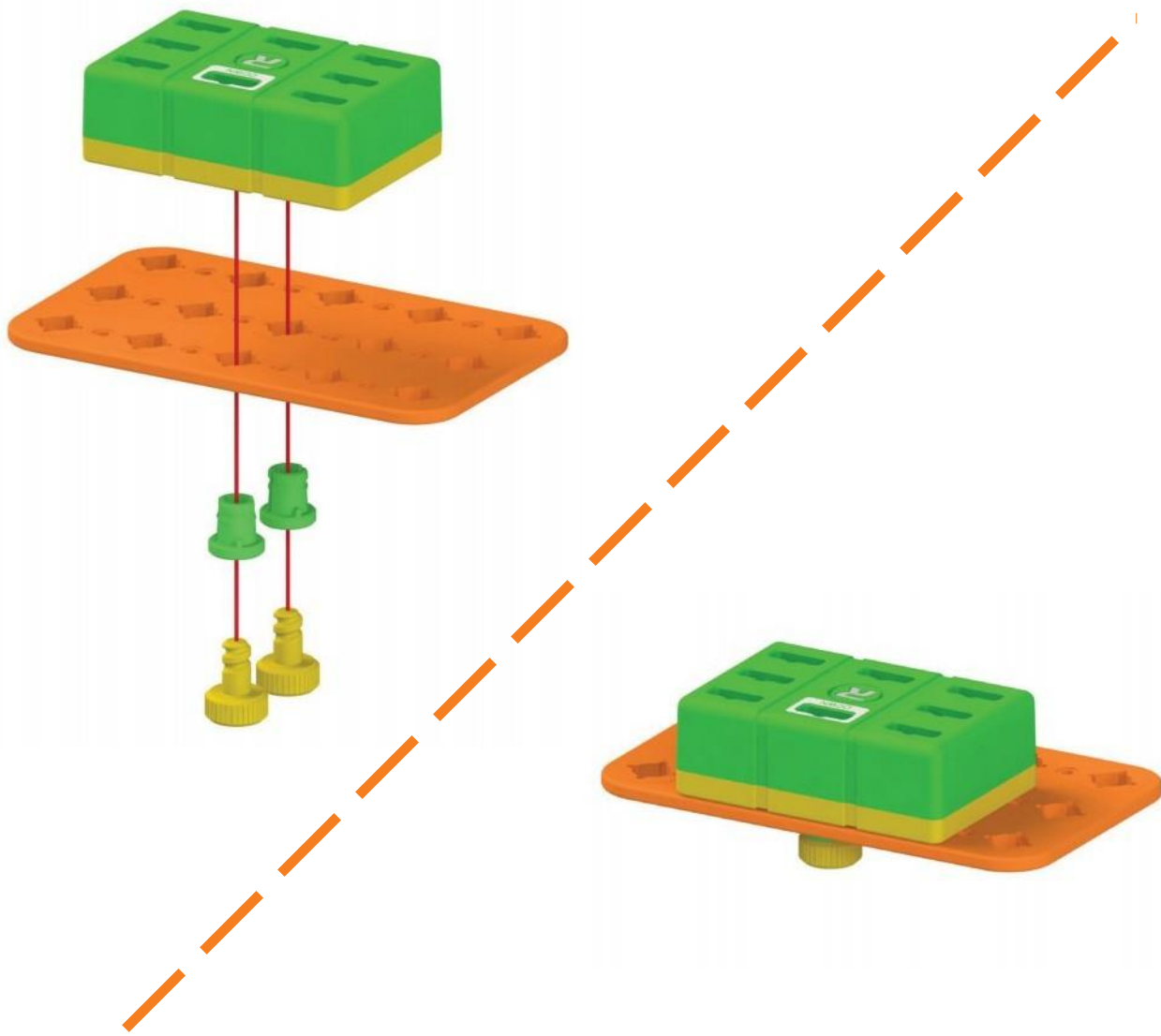

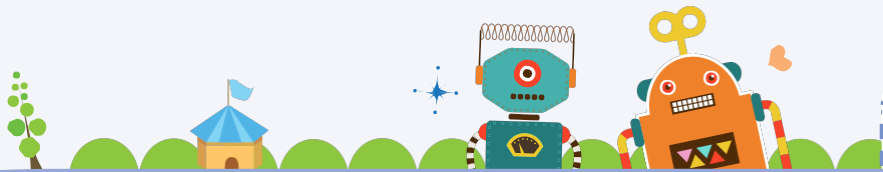

2

Детали



x2



x2



x2

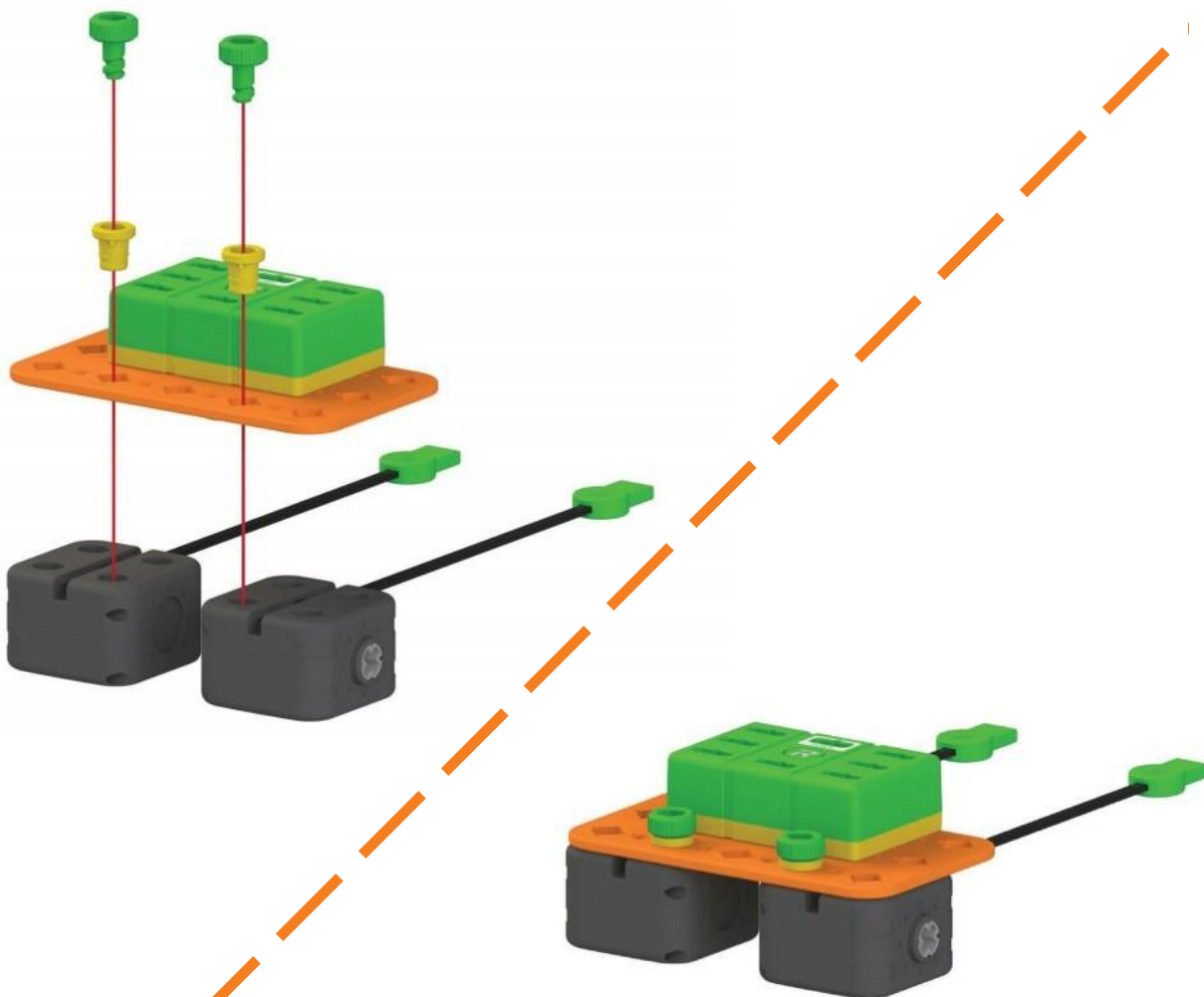

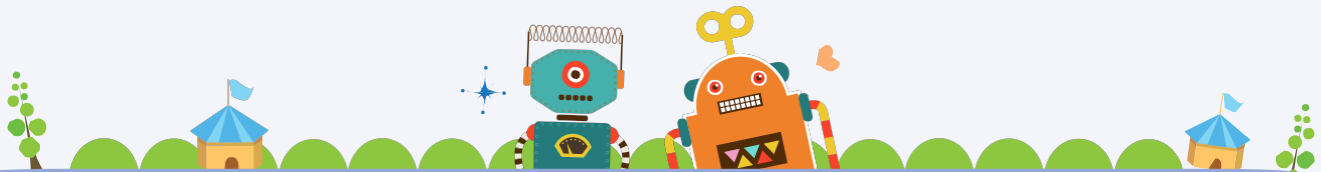

3

Детали



x2



x2



x2

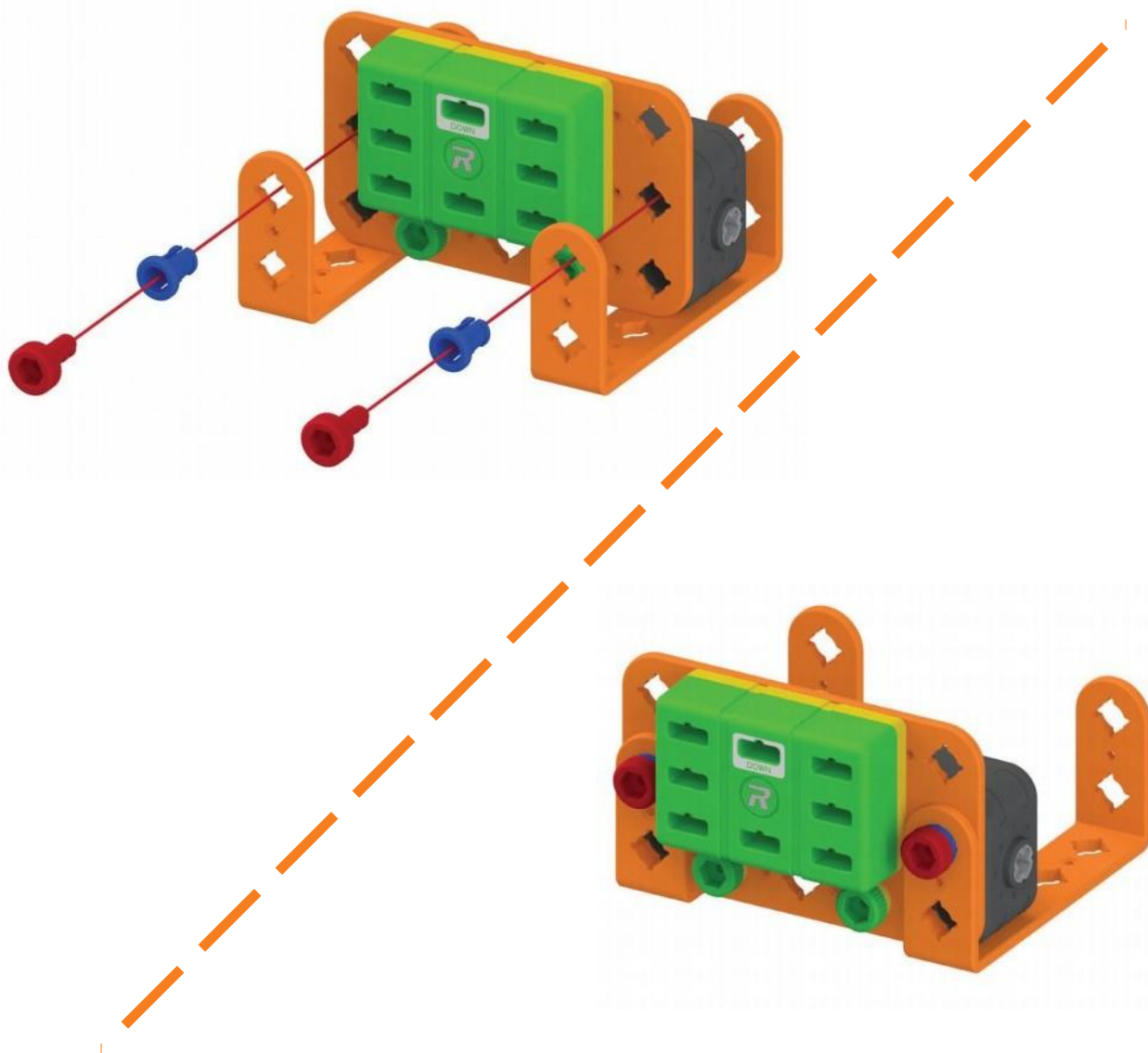

4

Детали



x1

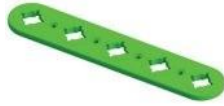

x1



x2



x2

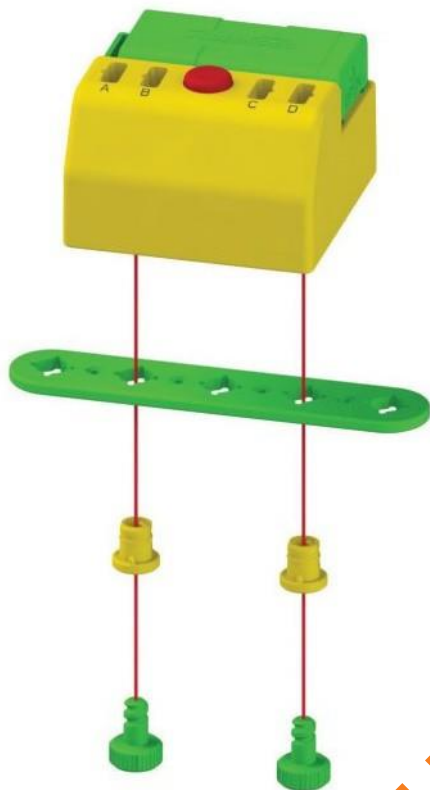

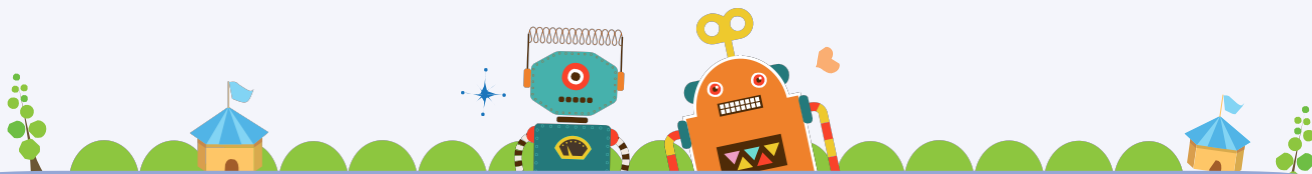

5

Детали



x2



x2

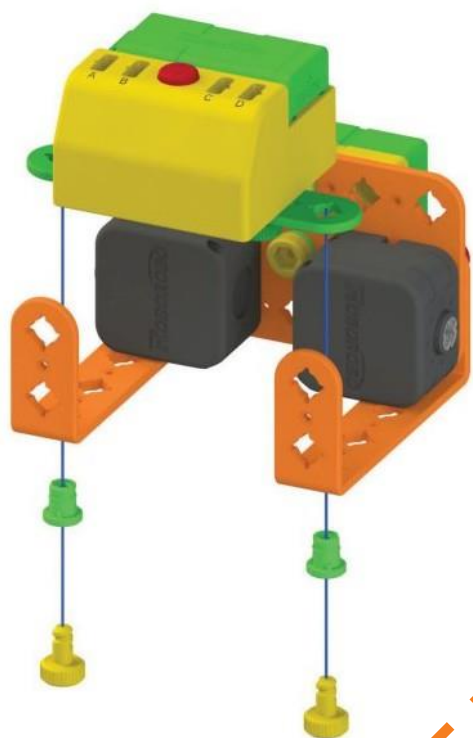



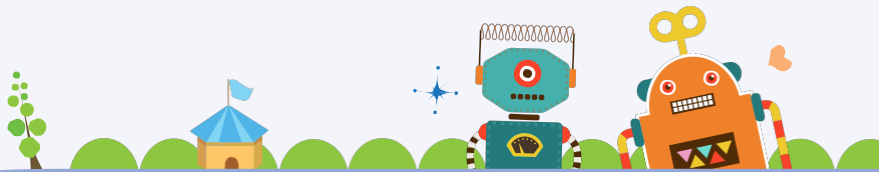

6

Детали



x2



x2



x2

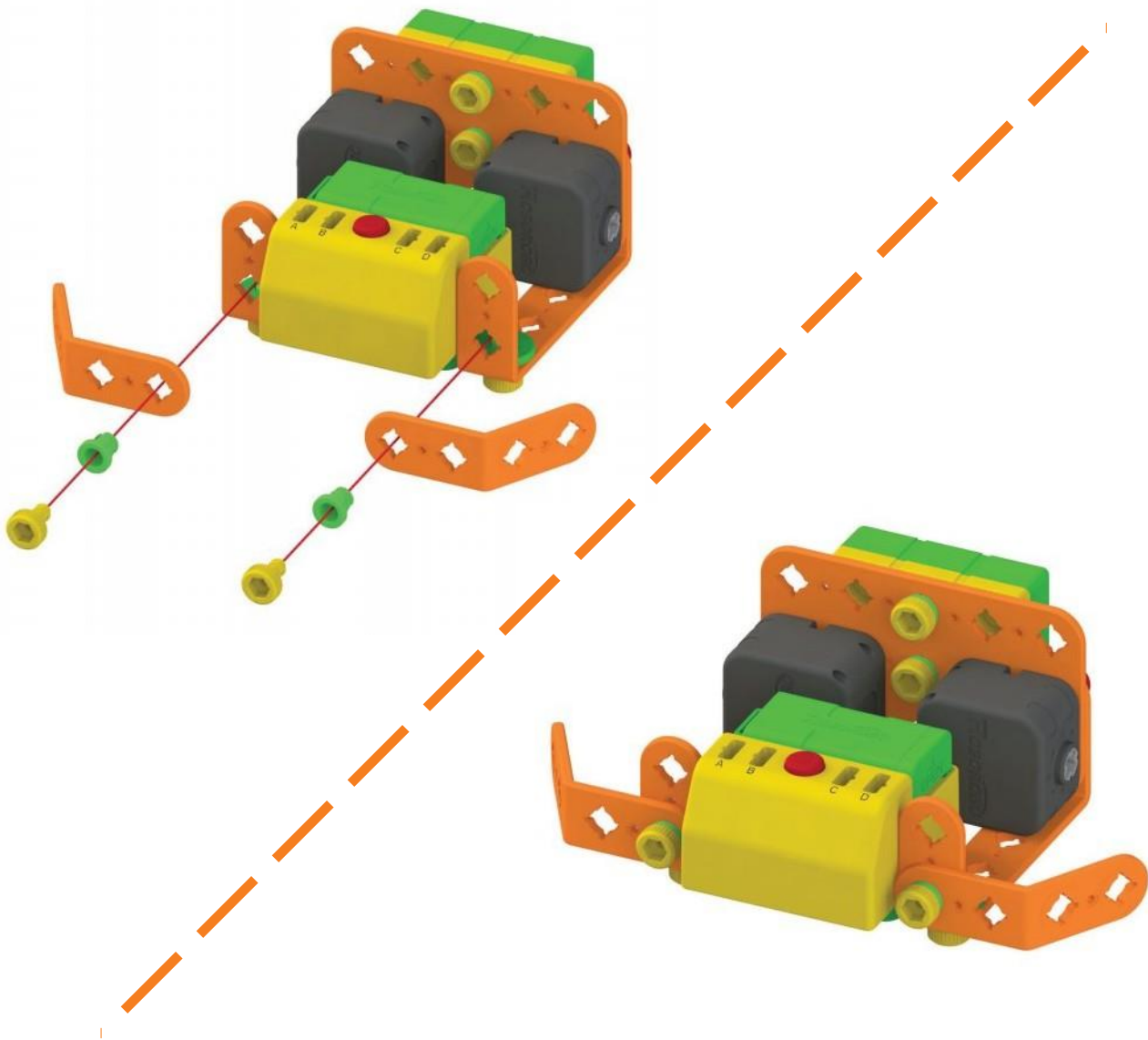

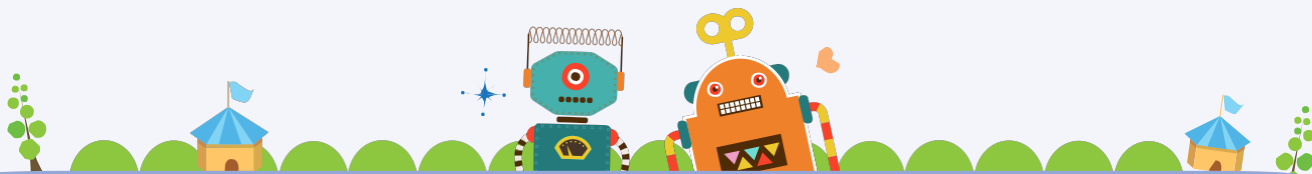

Детали



x2

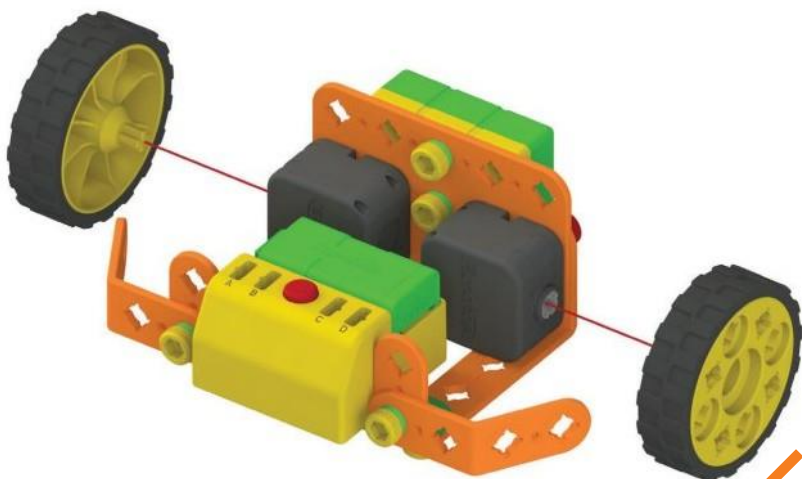

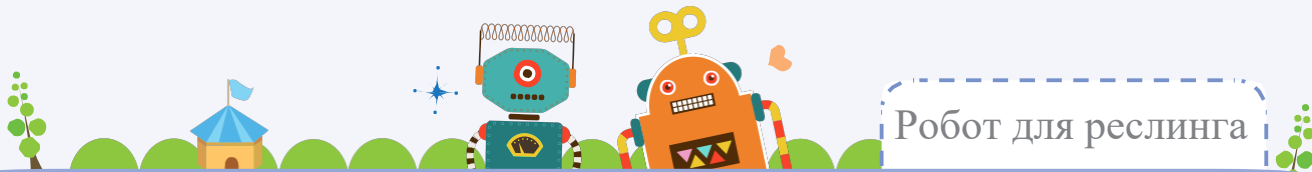

8

Детали



x2

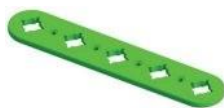

x2



x4



x4

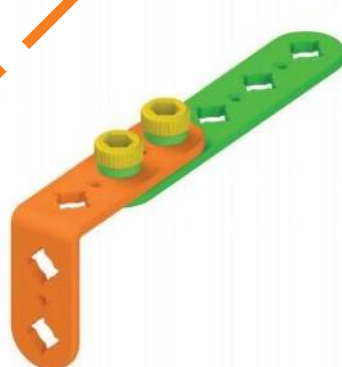
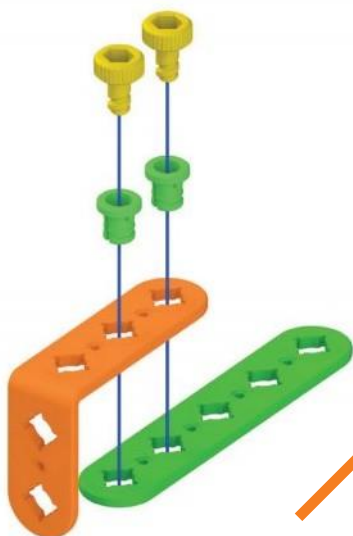

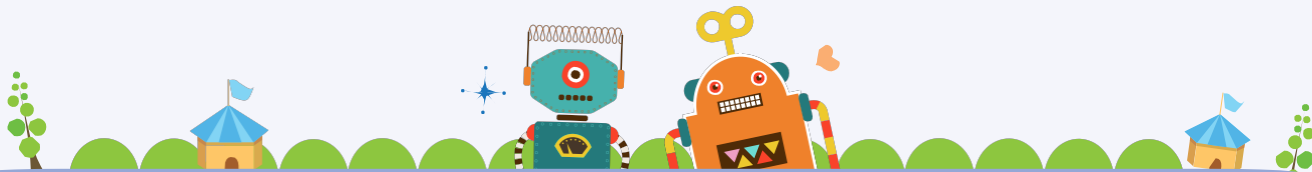

9

Детали



x2



x2



x2

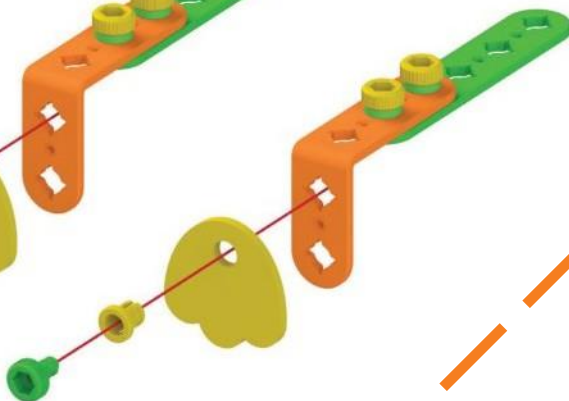
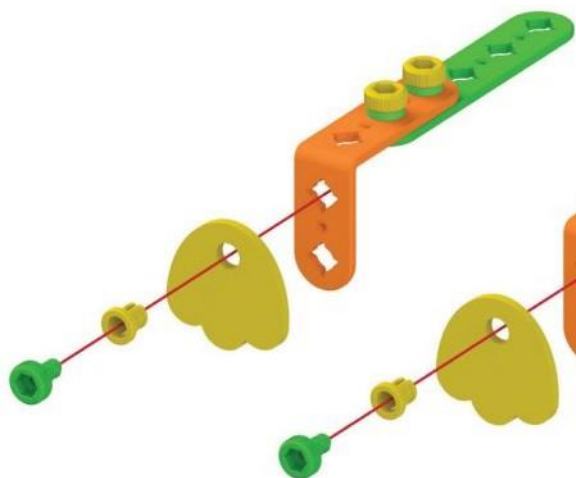

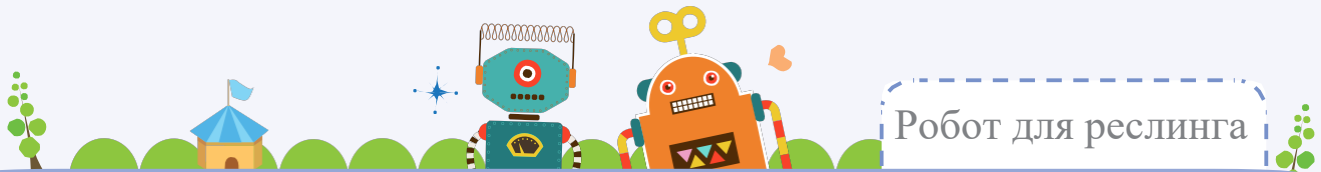

10

Детали



x2



x2

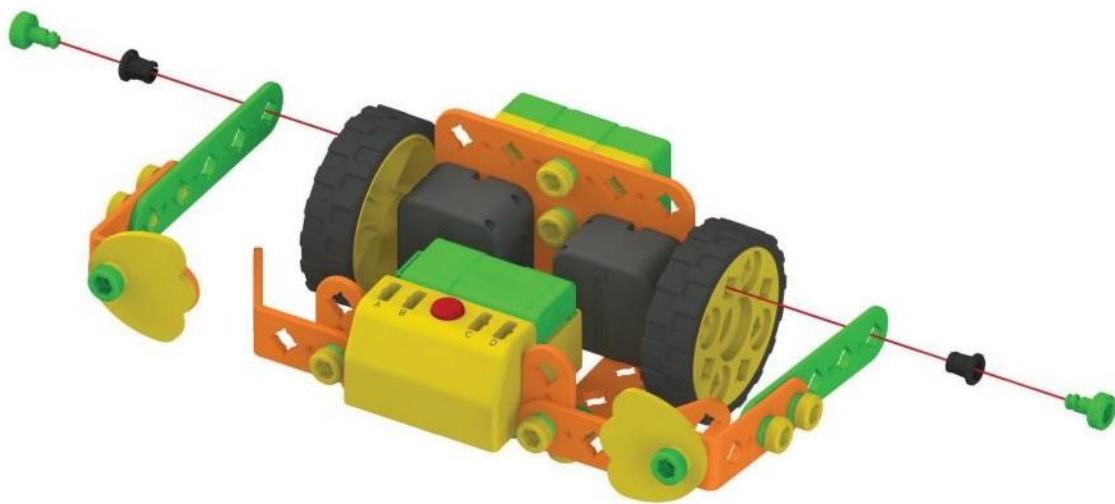



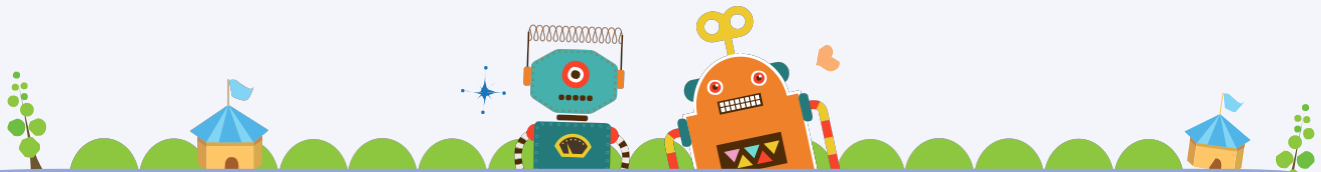

Детали



x2



x2



x2

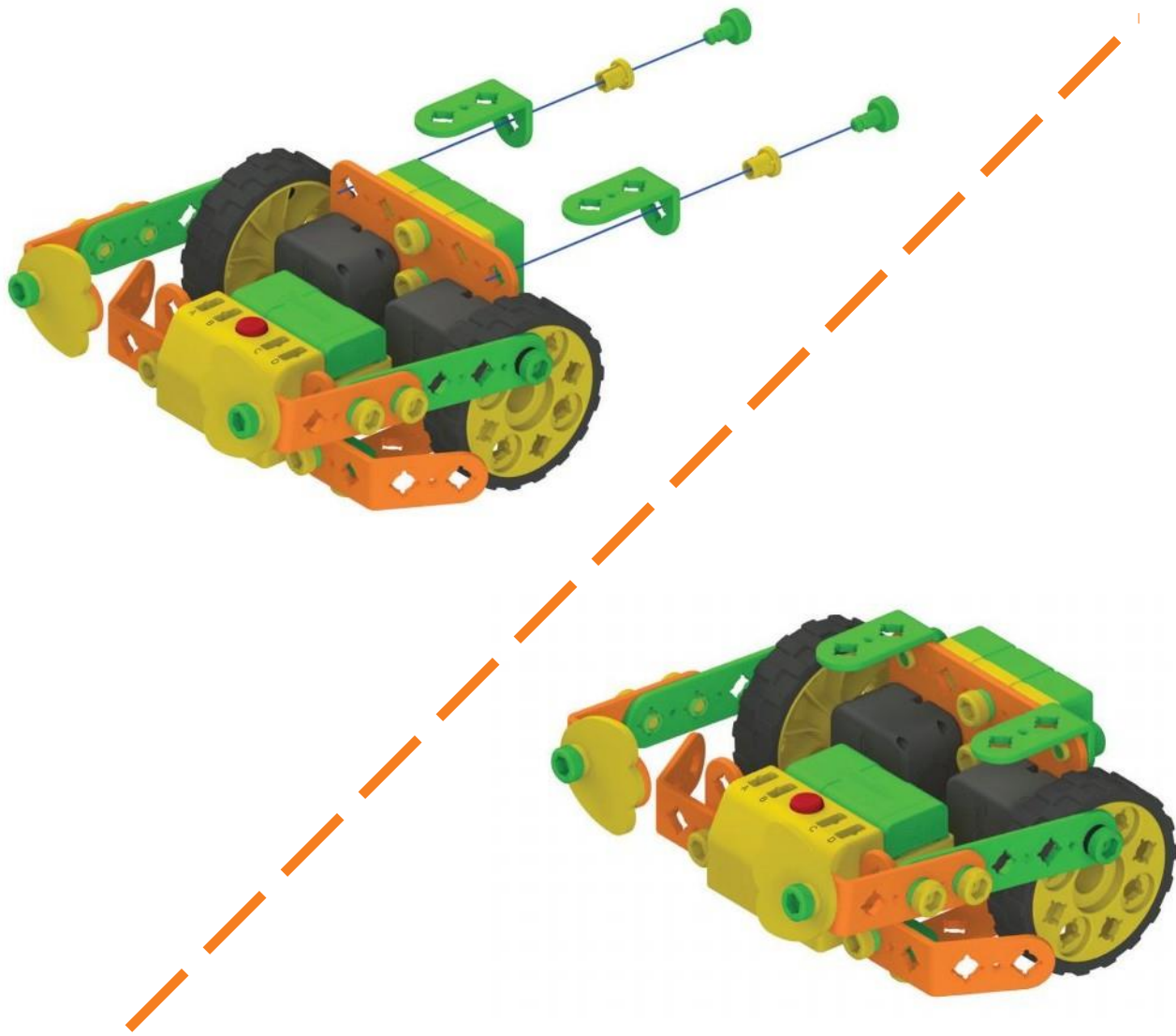

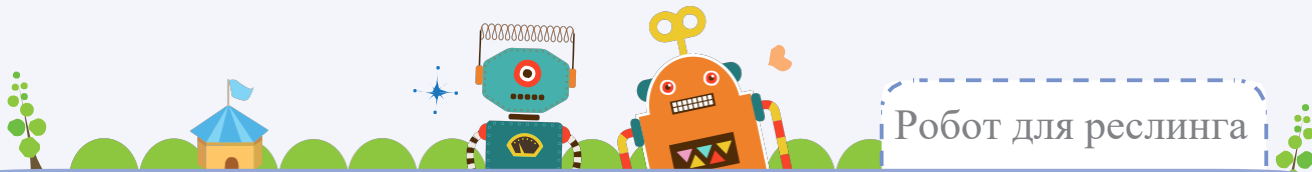

12

Детали



x1



x2



x2



x1



x1

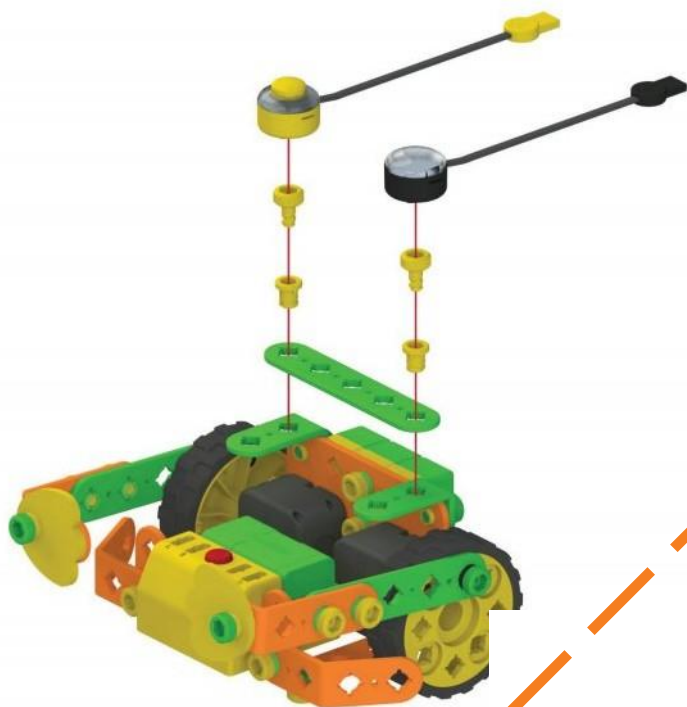

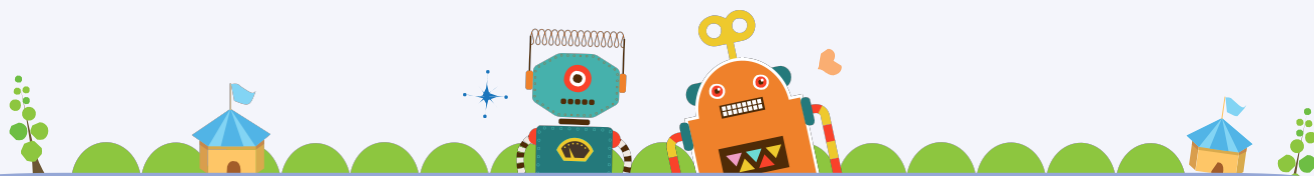

Правый  
электромотор  
Подключите к В

Левый  
электромотор  
Подключите к А

Двухсторонний кабель  
Подключите к порту D и ЦП

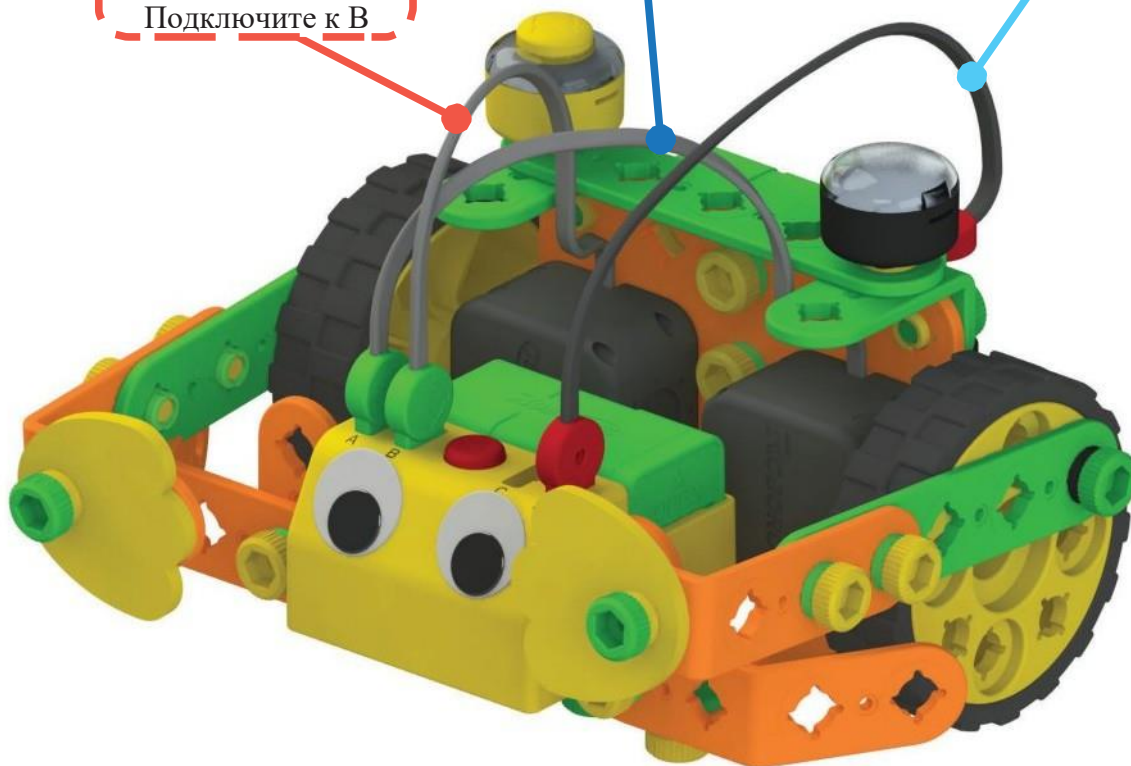

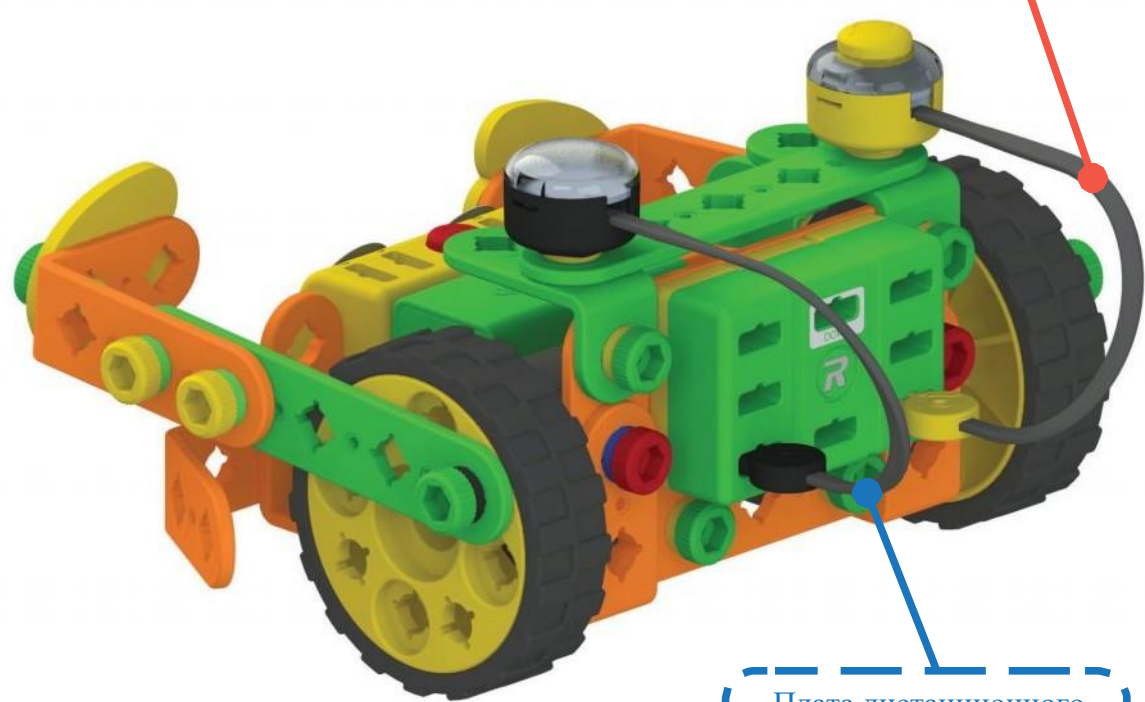
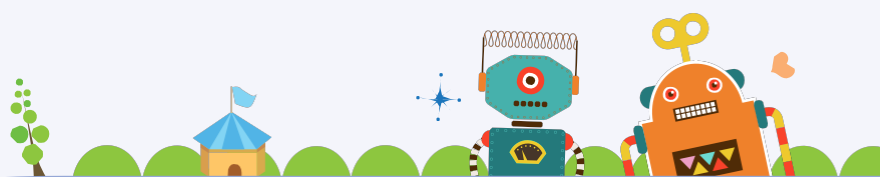

Контактный датчик (Y)  
Подключите к ЦП

Плата дистанционного  
приемника  
Подключите к ЦП



Запрограммируем движение  
робота для реслинга на программной плате.

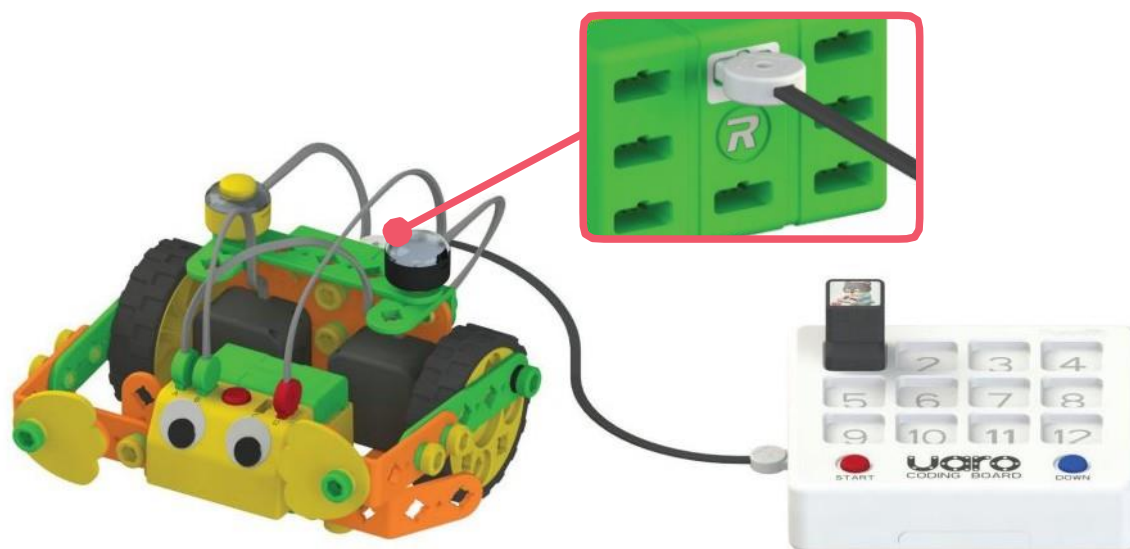

Управляйте роботом для реслинга с помощью устройства  
дистанционного управления



2-й



Сыграем с роботом для настольных игр

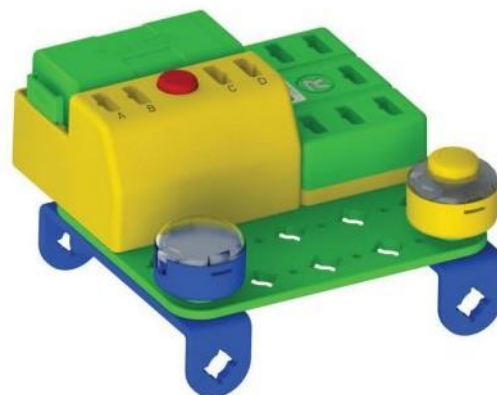

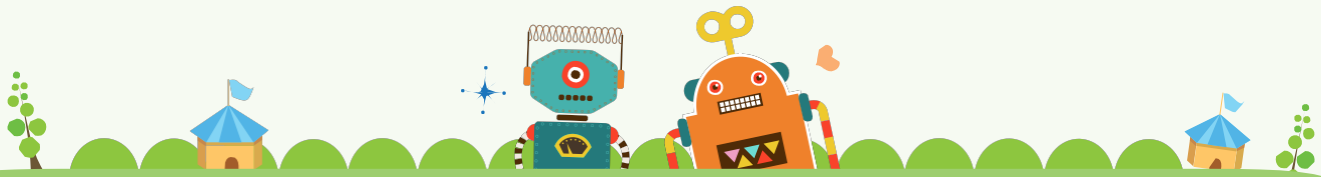

Детали



x1



x1

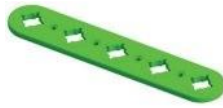

x1



x2



x2

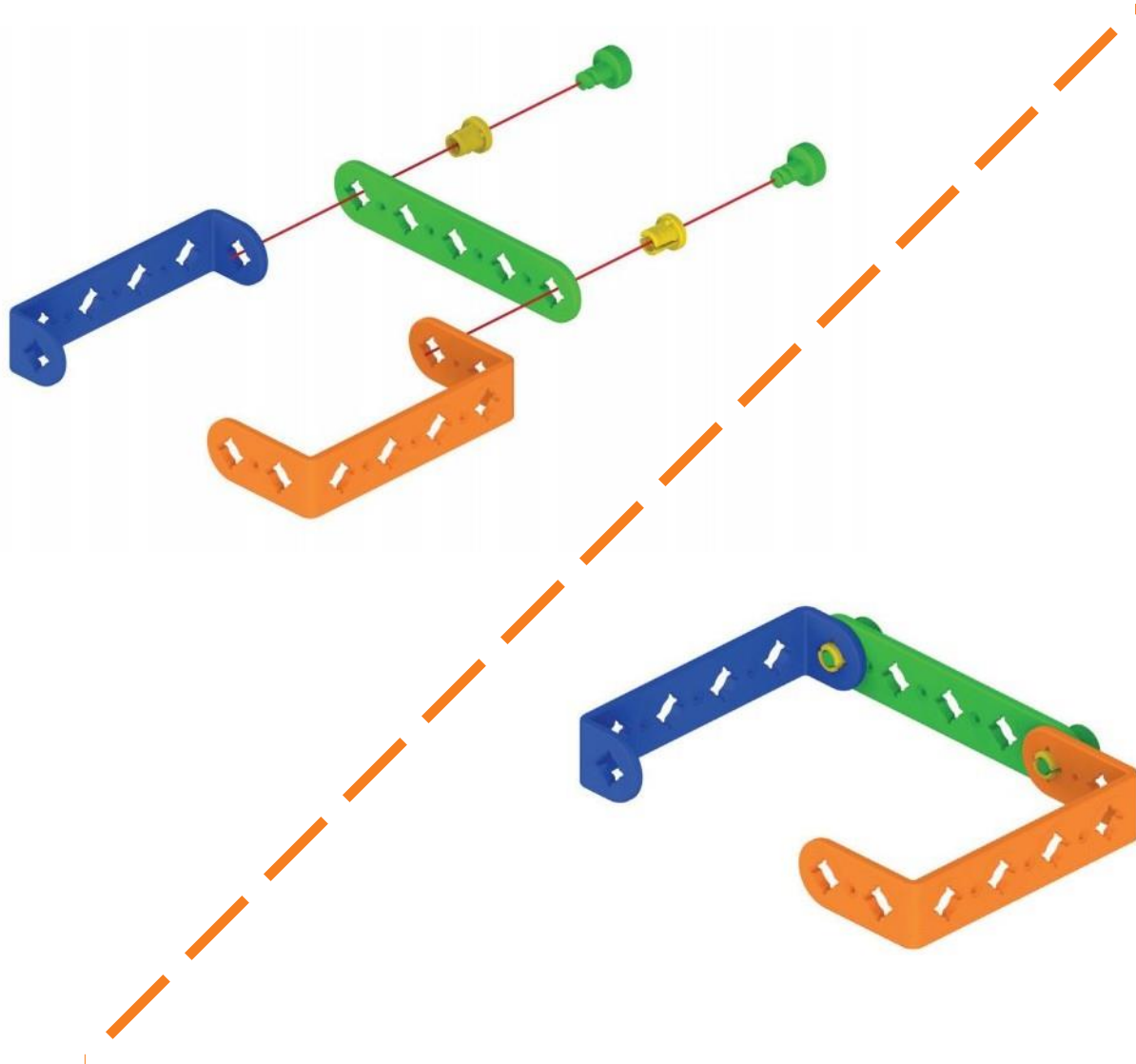

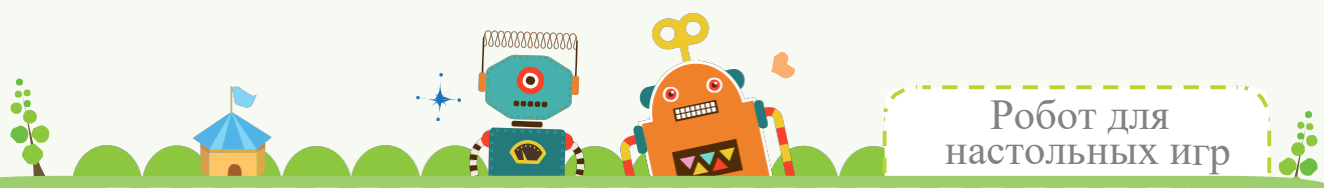

2 Детали

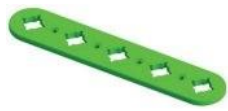

x1



x2



x2

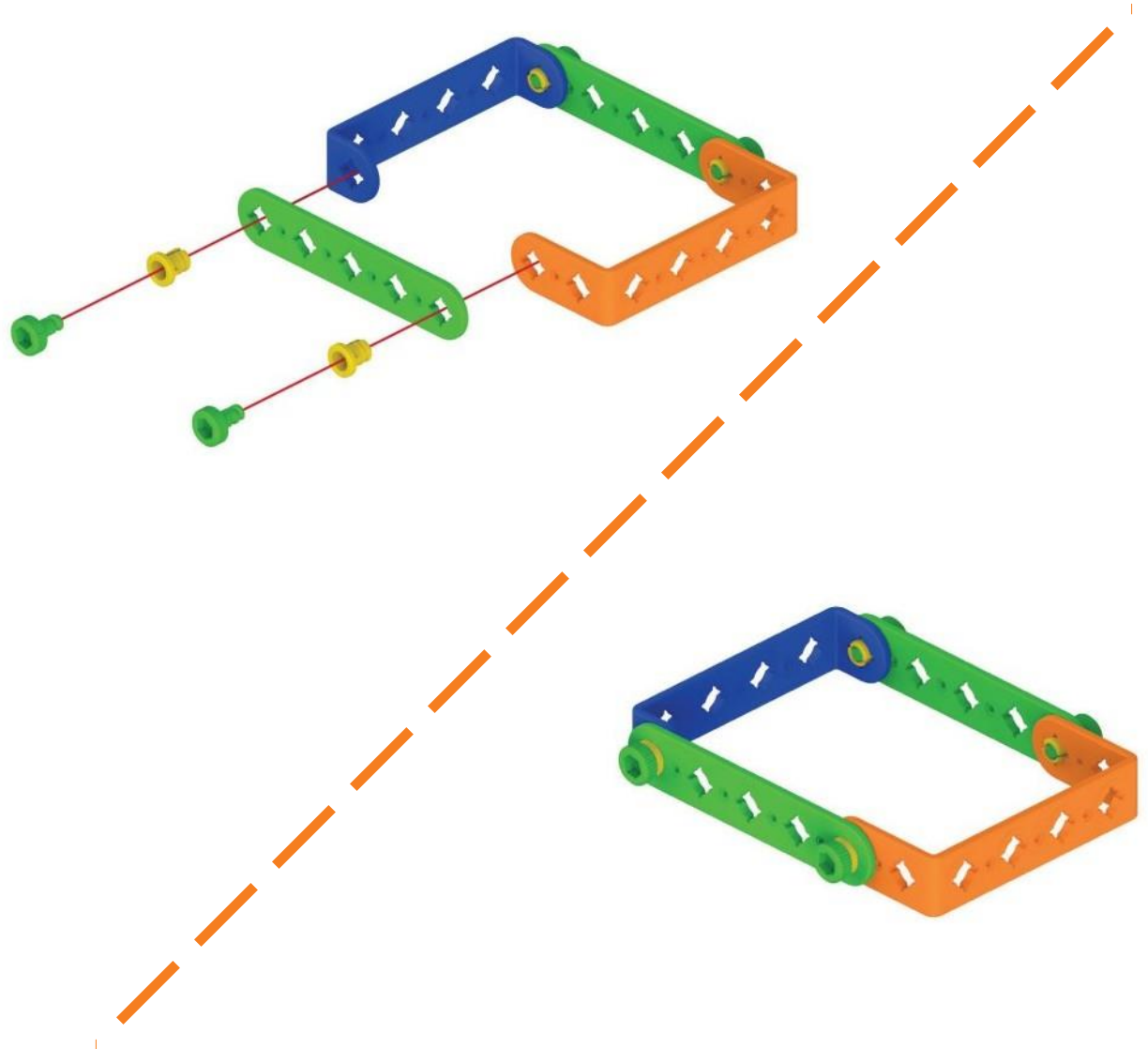

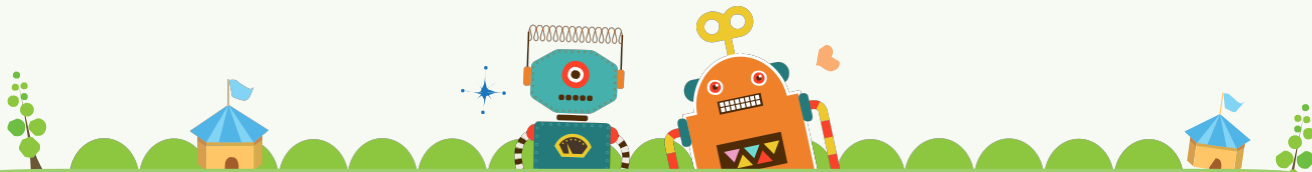

3

Детали



x2



x2



x2

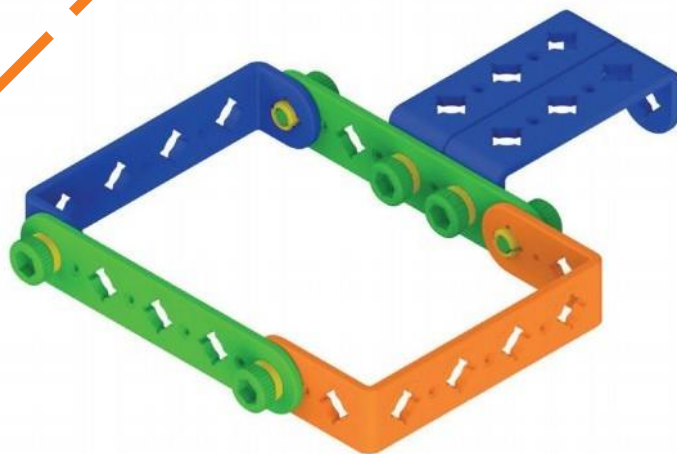
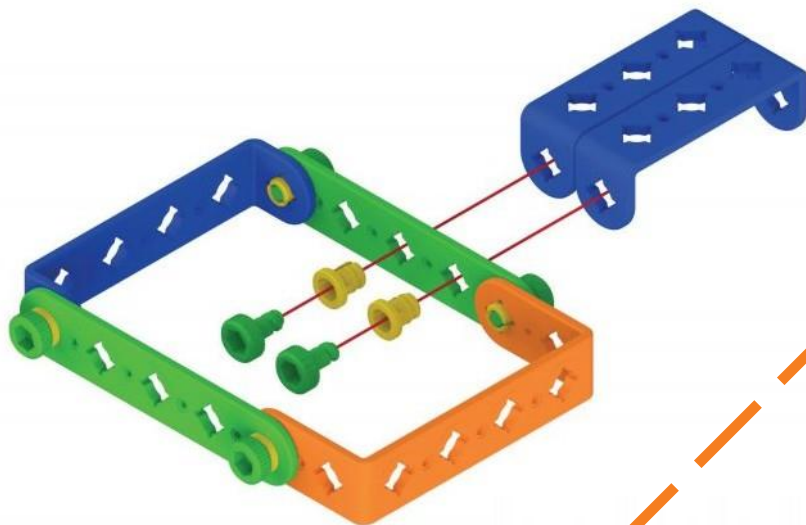

4 Детали



x1



x2



x2



x2

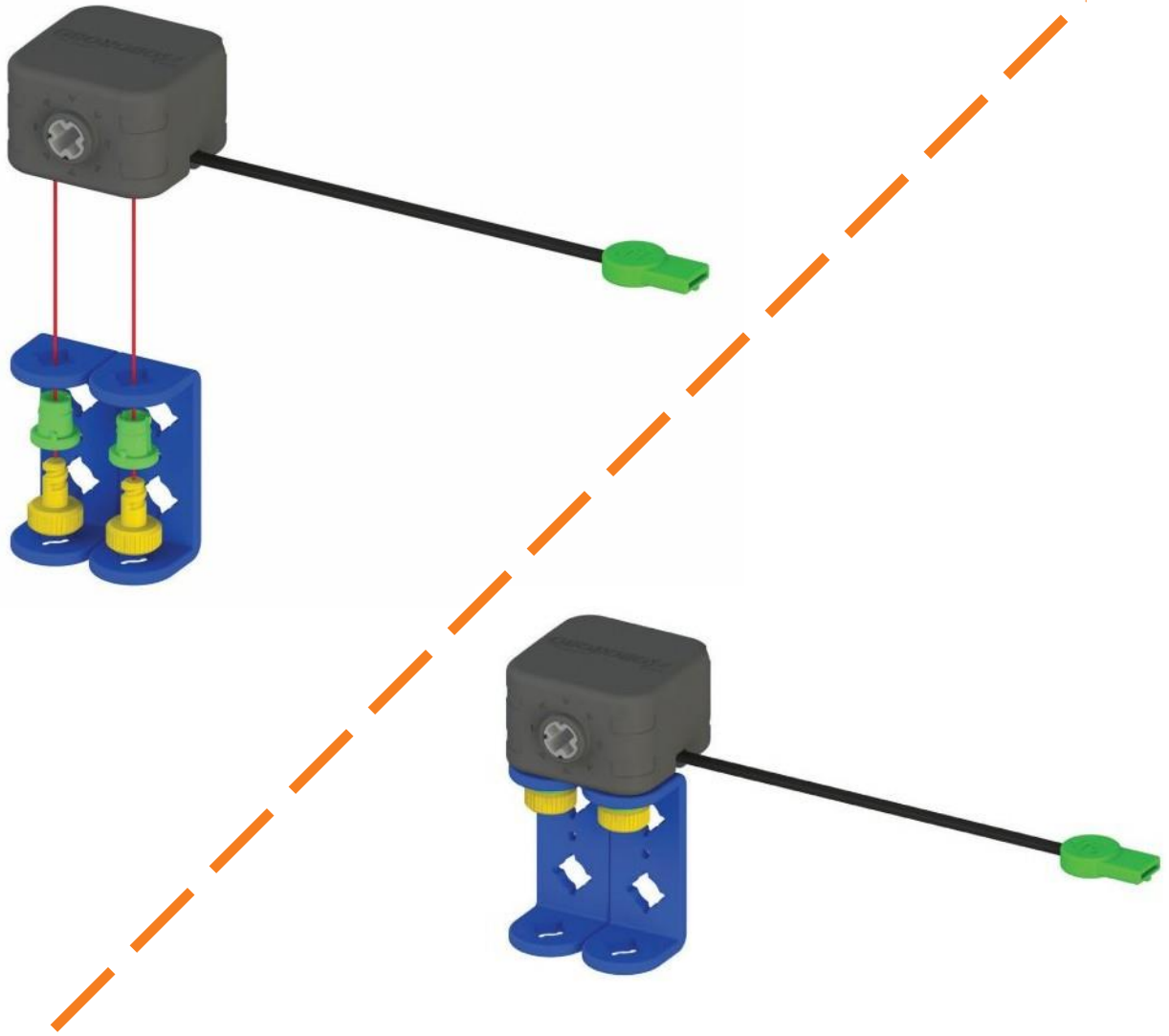

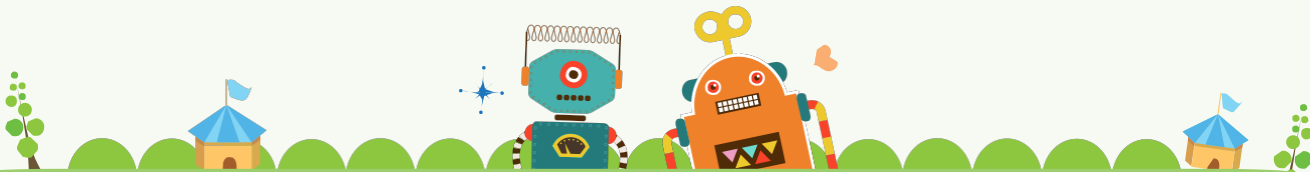

5

Детали



x1

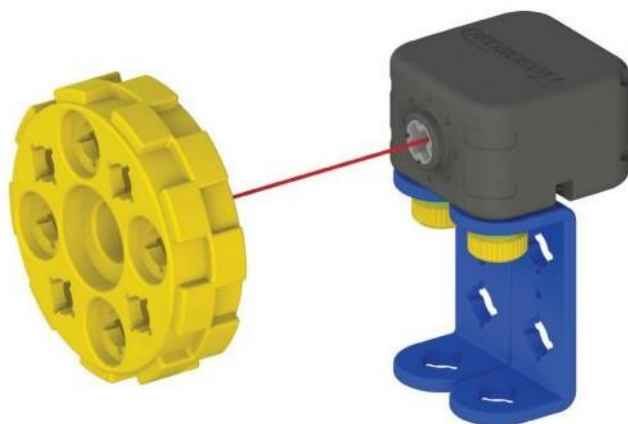



6

Детали



x1



x1



x1

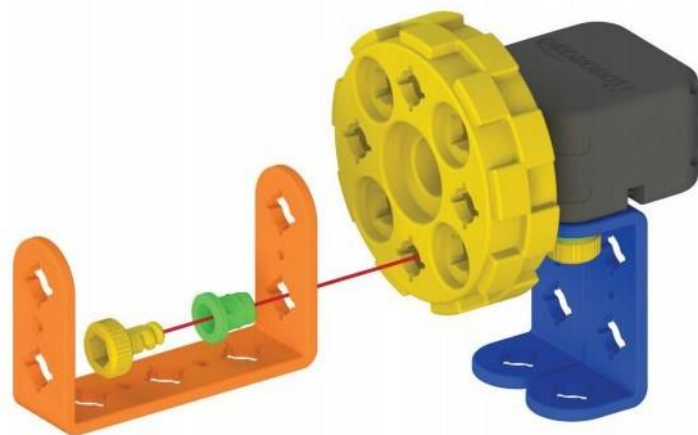

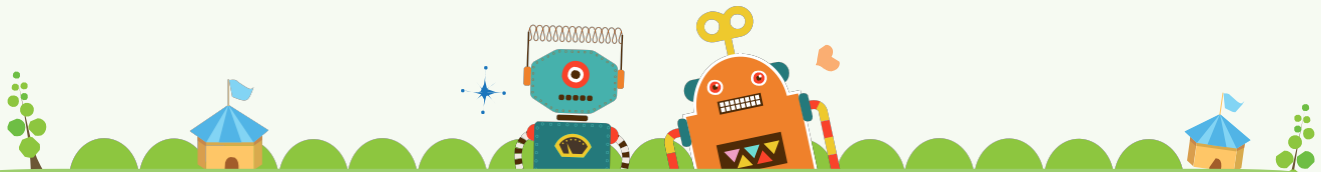

Детали



x2



x2



x2

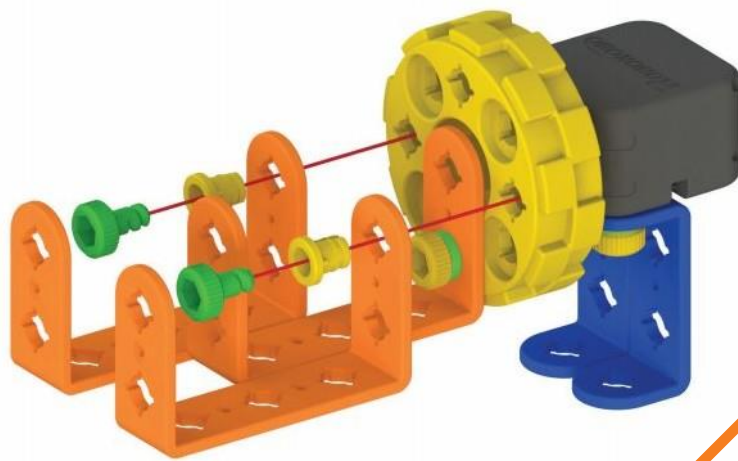

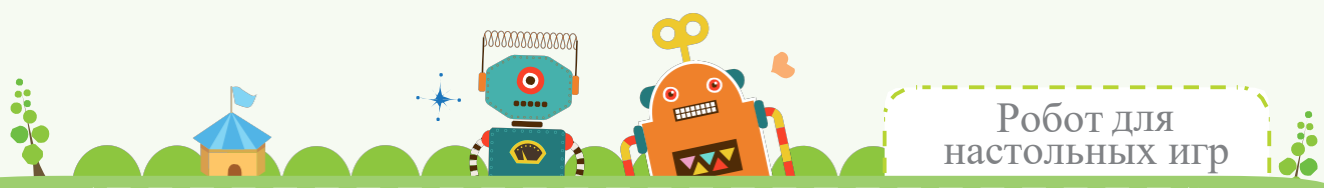

8 Детали



x2



x2



x2

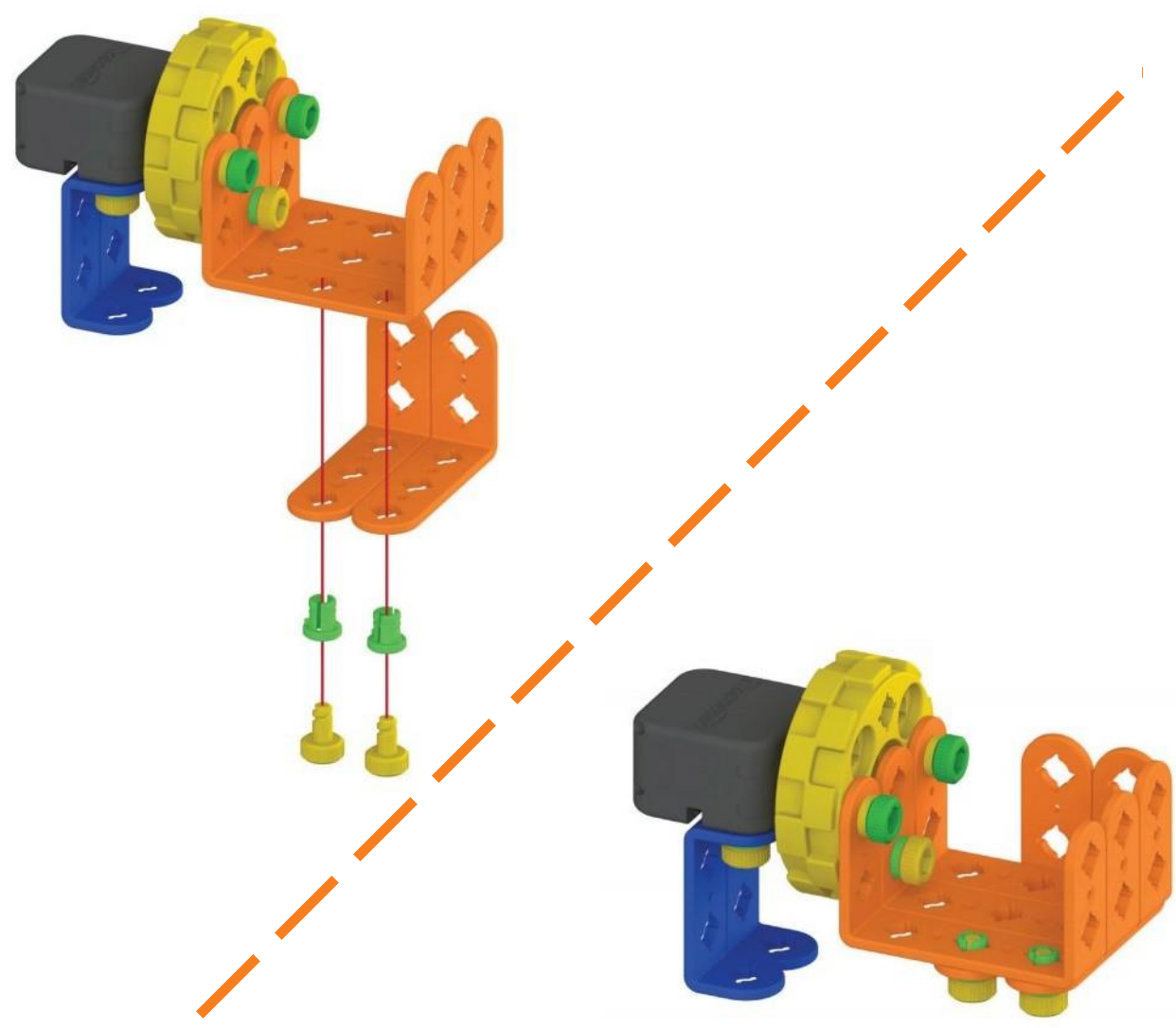

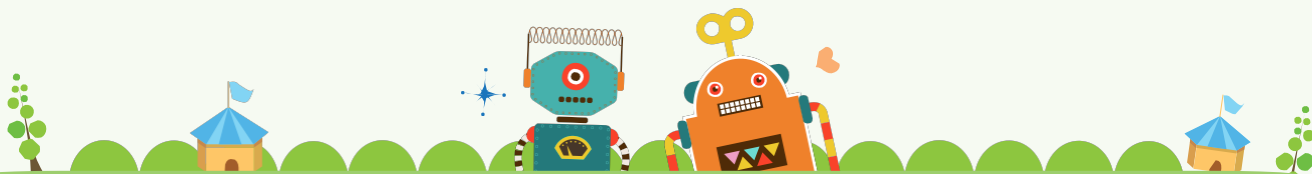

9

Детали



x2



x2

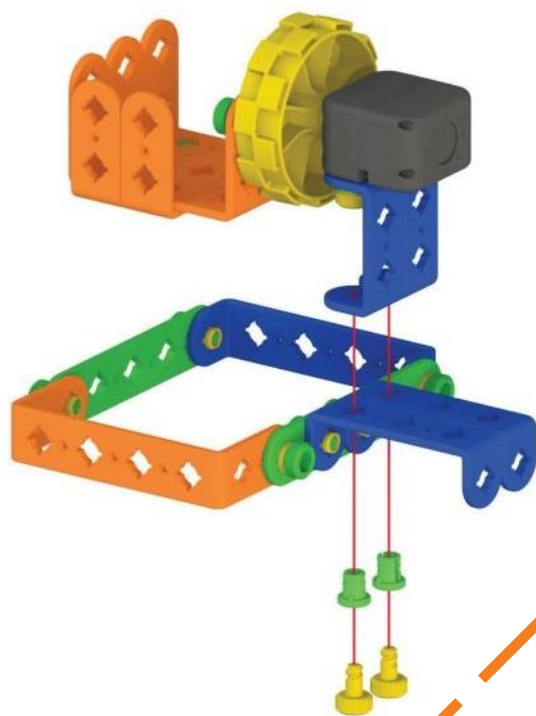

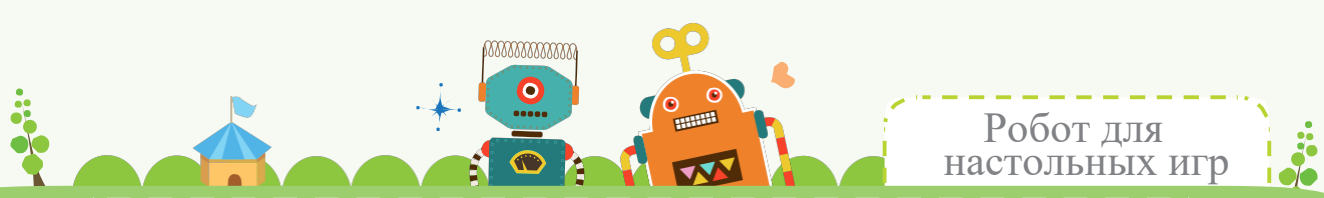

10

Детали



x1



x1

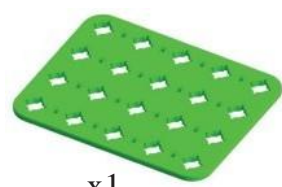

x1



x2



x2

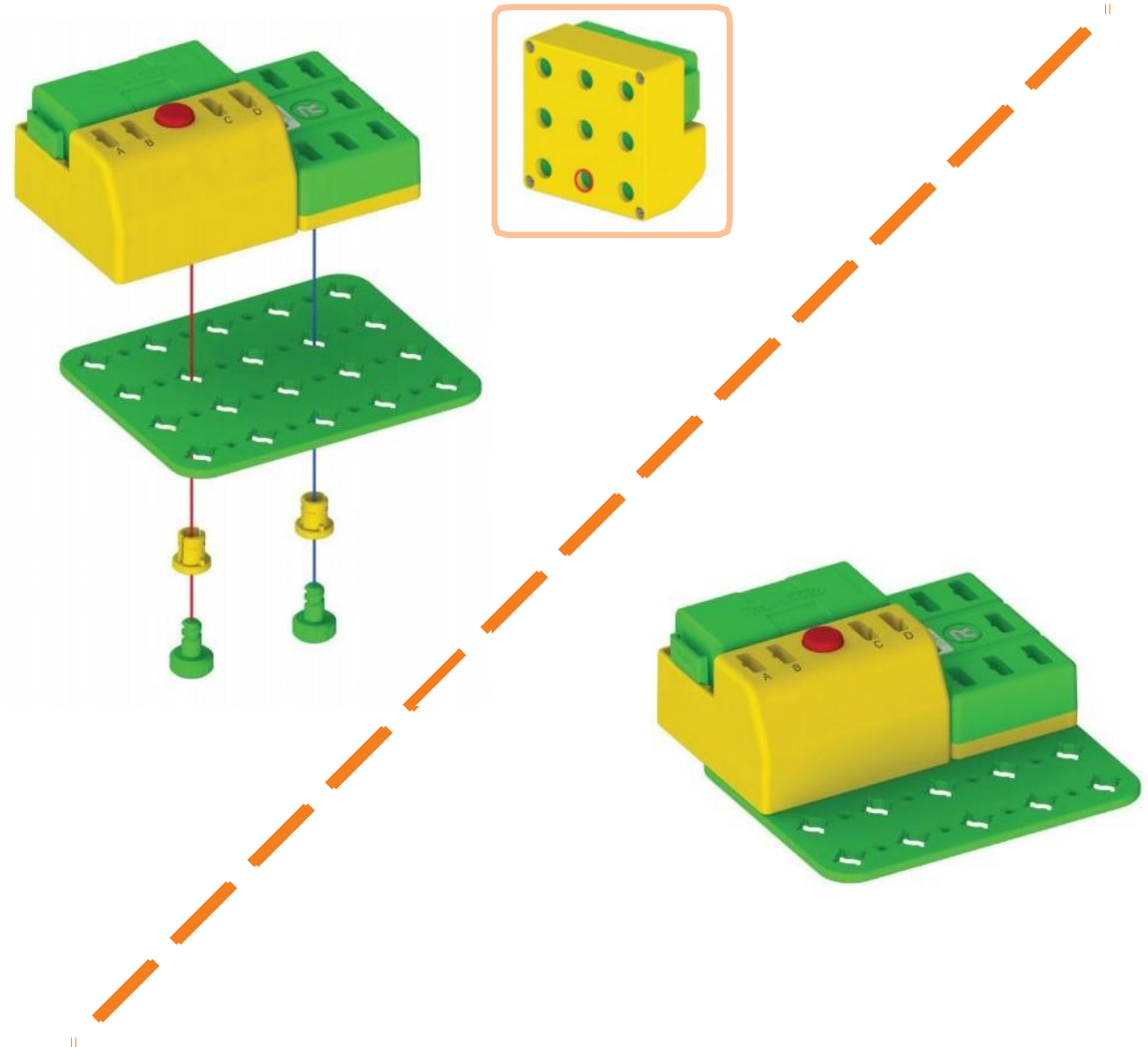

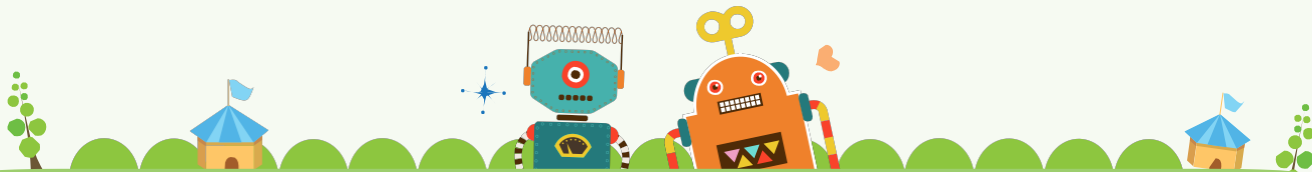

Детали



x2



x2



x2



x2



x2

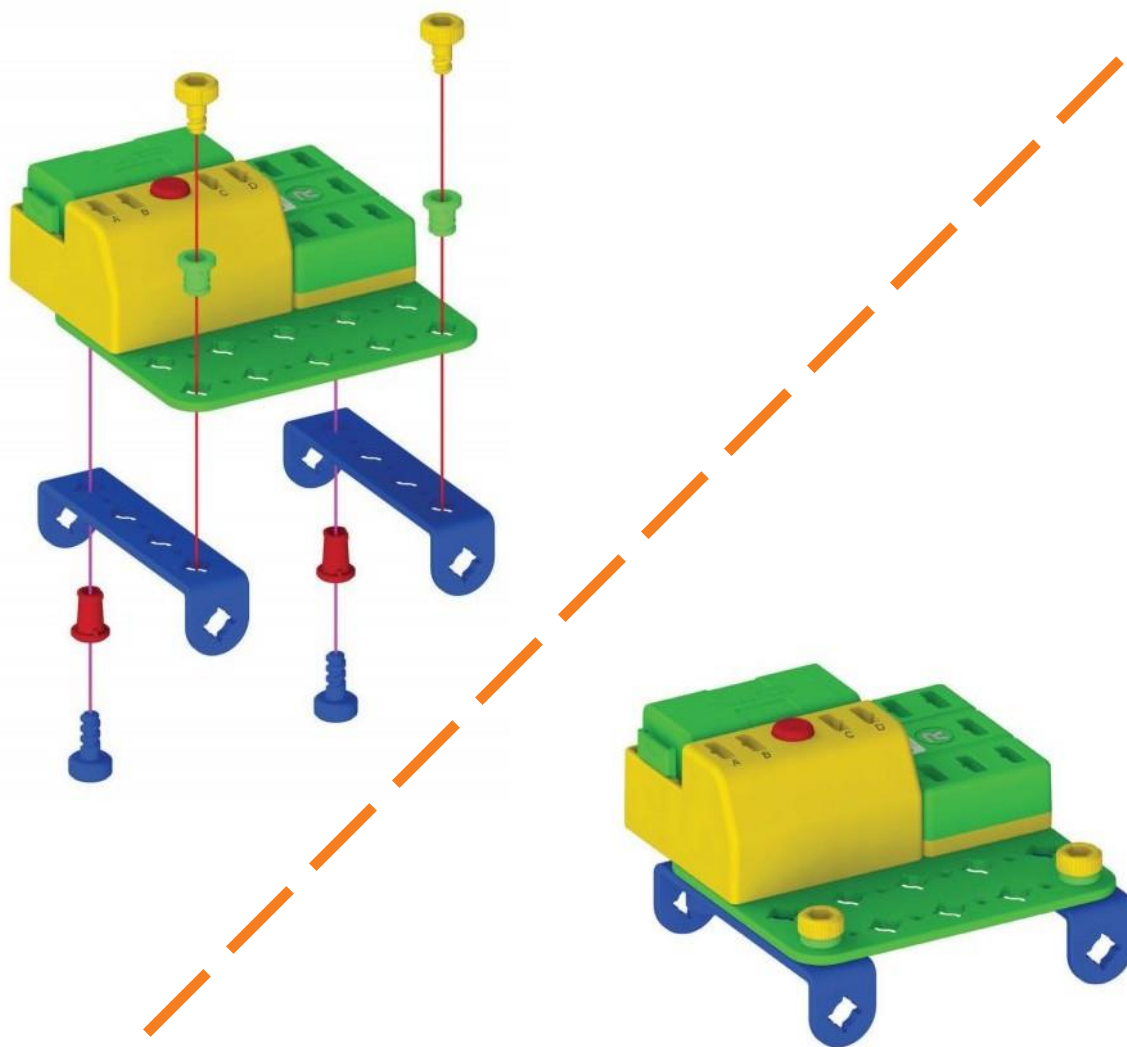



12 Детали



x1



x1

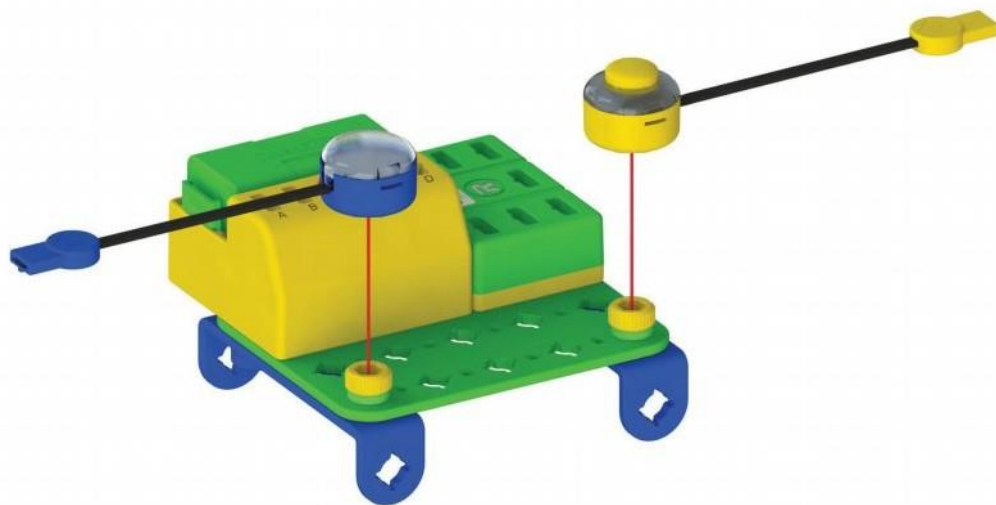

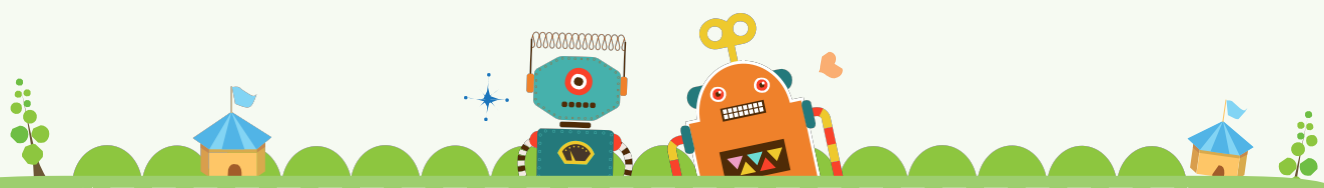

Двухсторонний кабель  
Подключите к порту D и ЦП

Электромотор  
Подключите к  
В

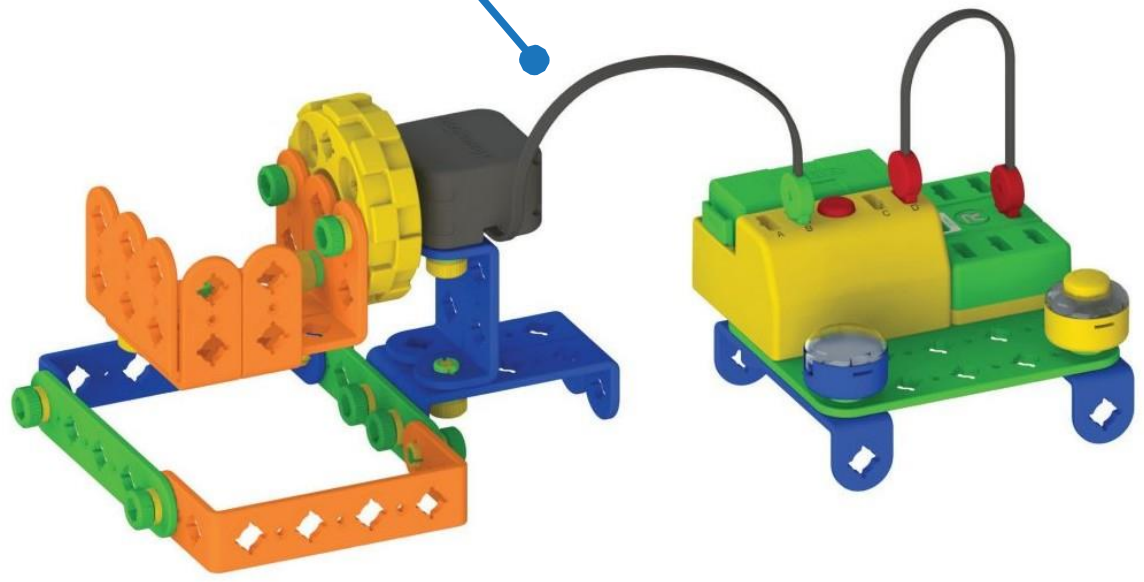

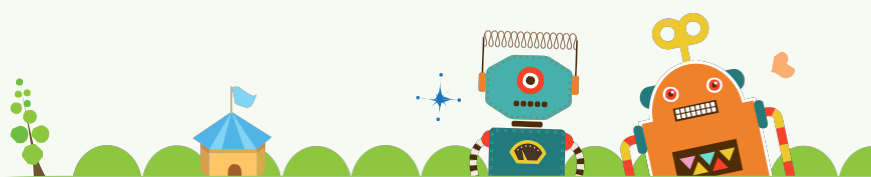

Робот для настольных игр

LED  
Подключите к ЦП

Контактный датчик (Y)  
Подключите к ЦП

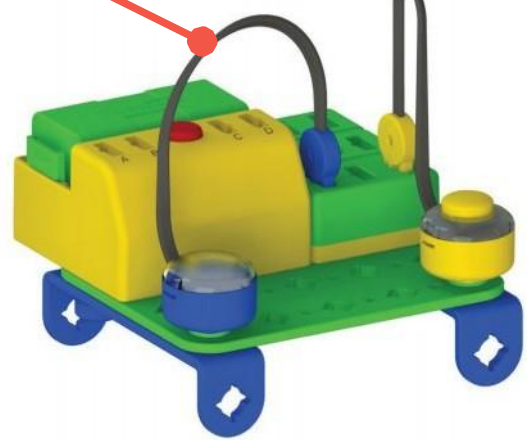
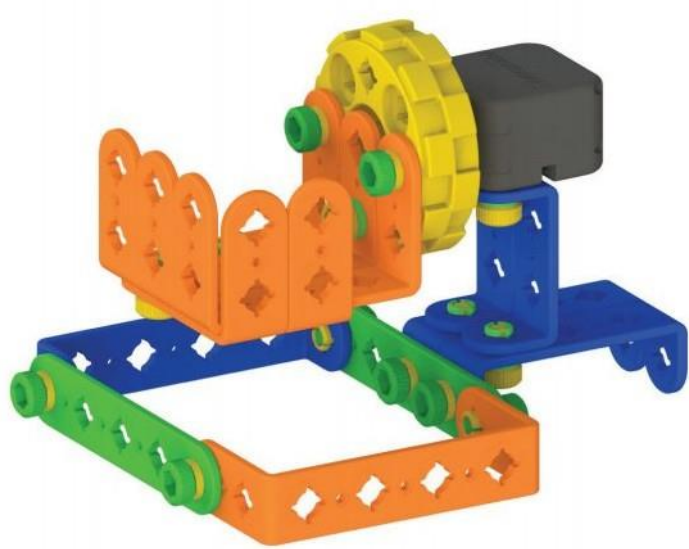



Украсьте робота для настольных игр  
(стр. 216)

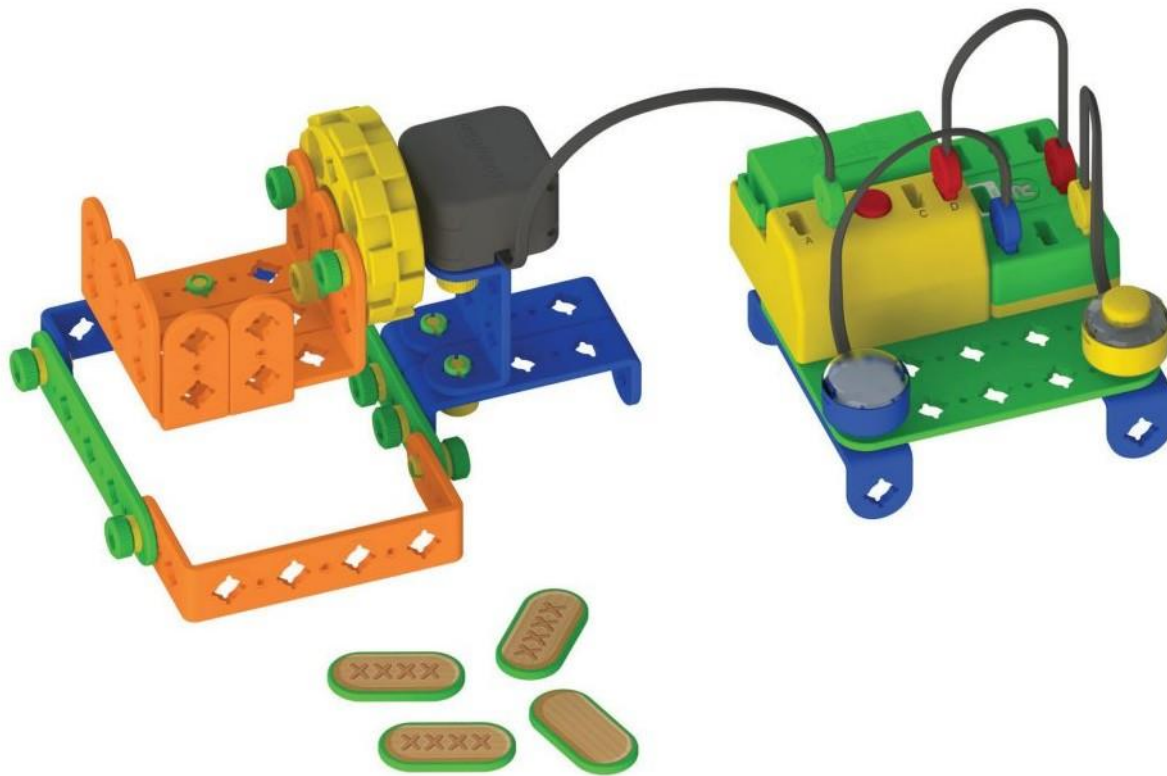

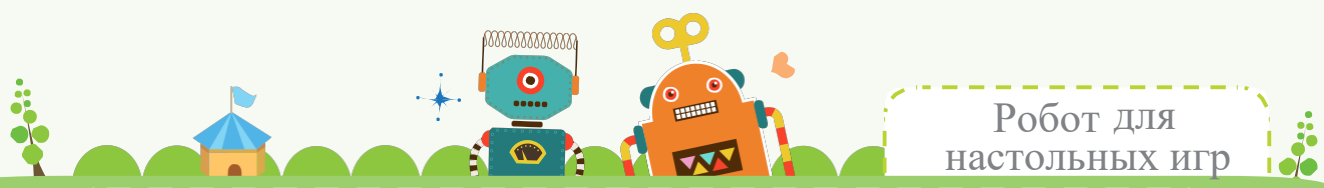

Создадим Программу

Запрограммируем движение робота для настольных игр на программной плате.

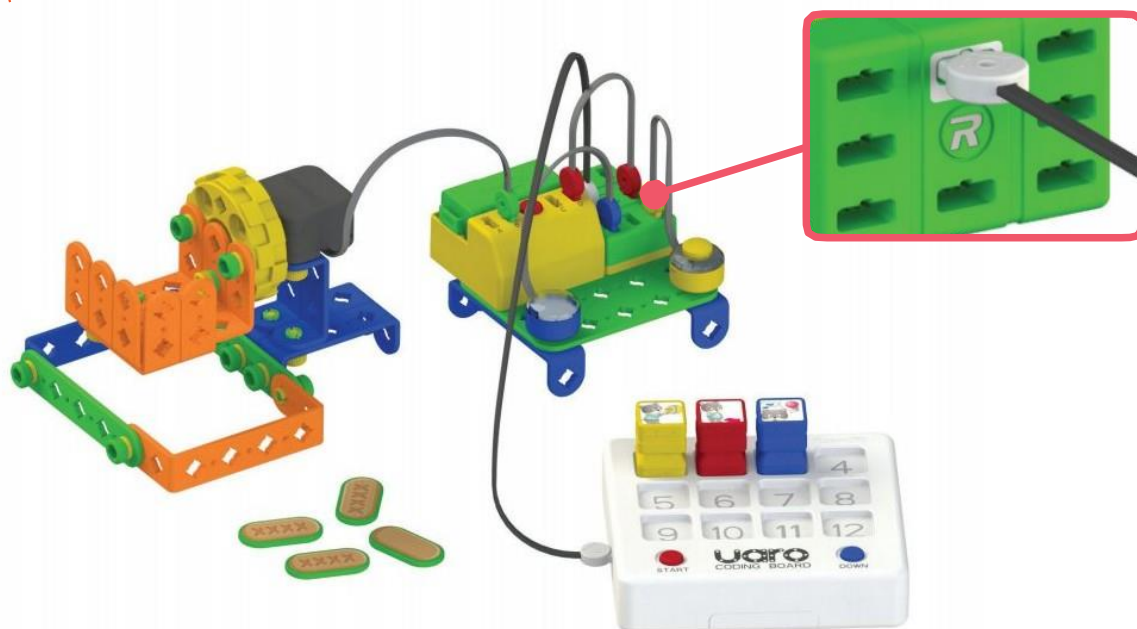

При нажатии на контактный датчик блок повернется и загорится красный LED.

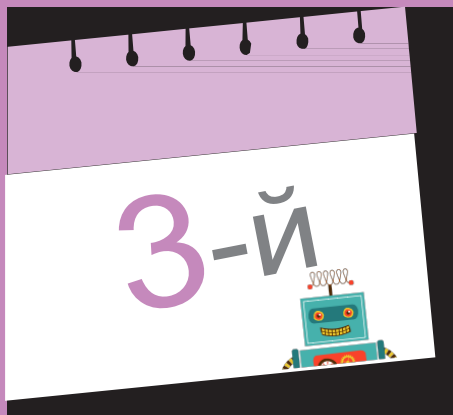

Сделаем робота-футболиста





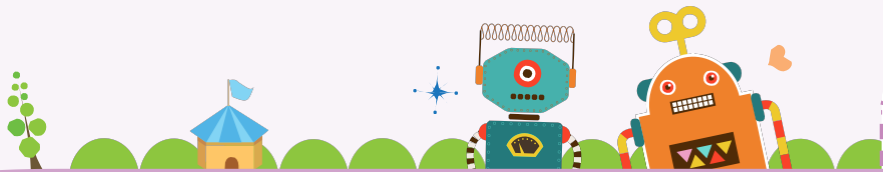

Детали



x2



x1



x4



x4

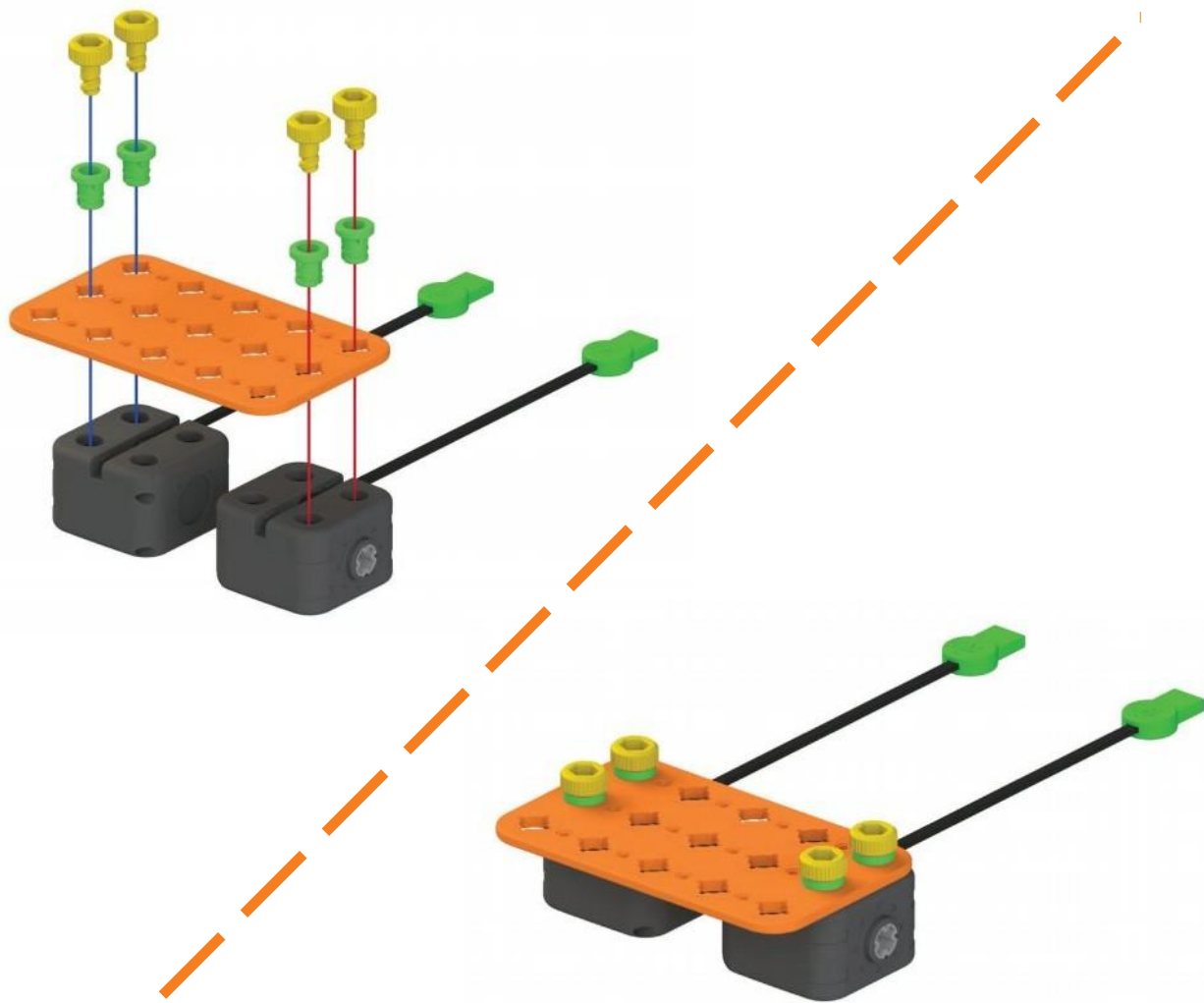

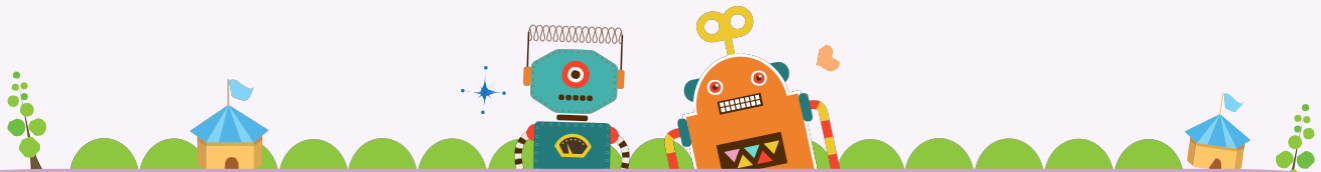

2

Детали



x2



x2



x2

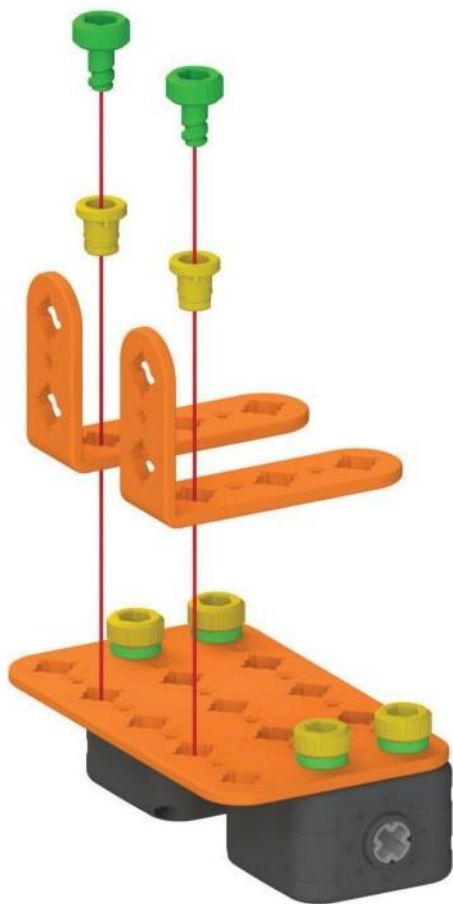

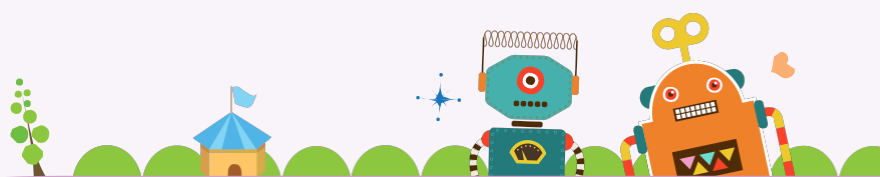

3 Детали



x1



x2



x2

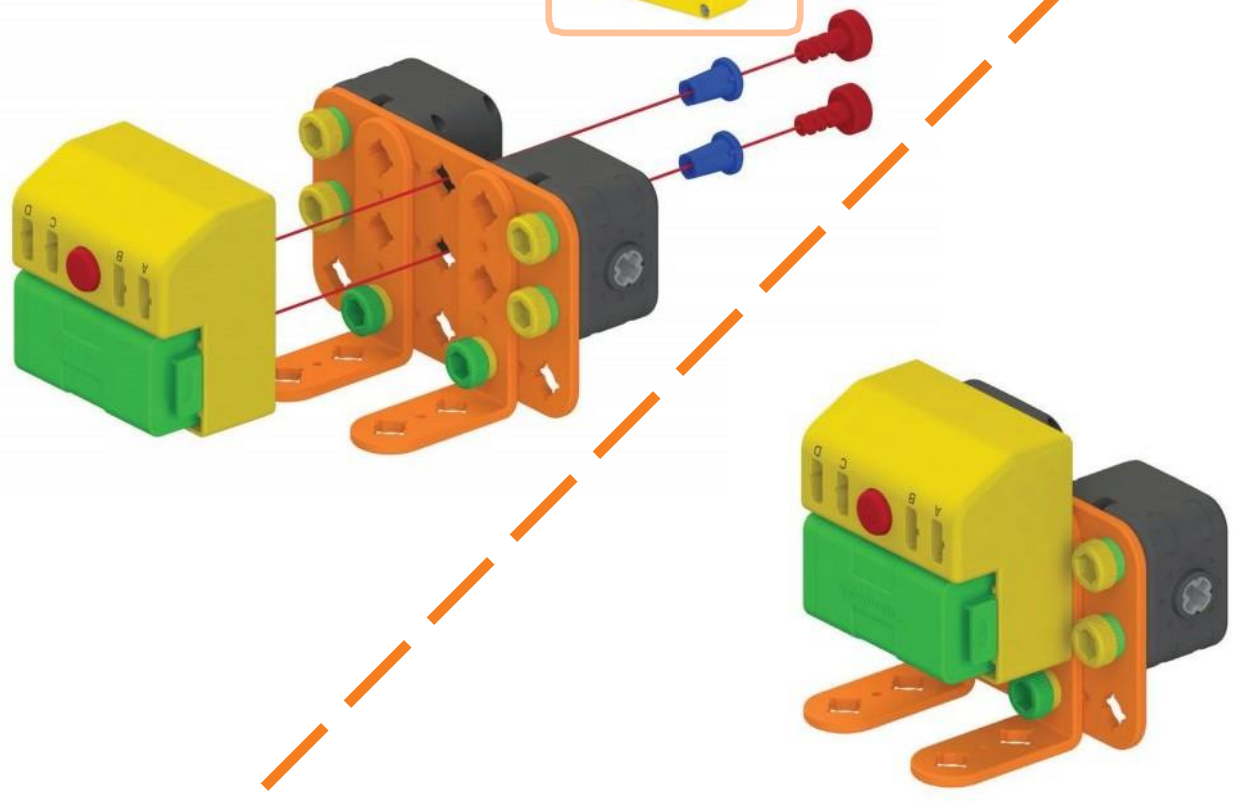

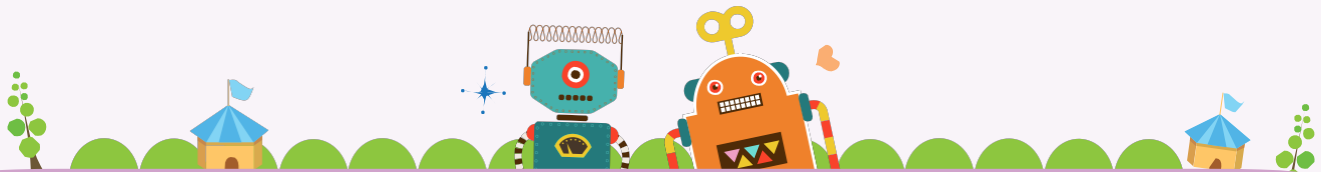

4

Детали



x1



x2



x2

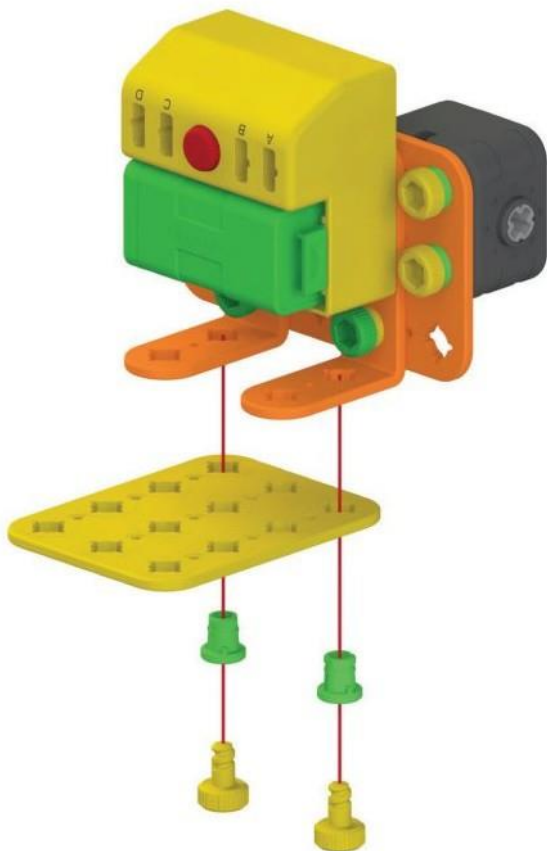

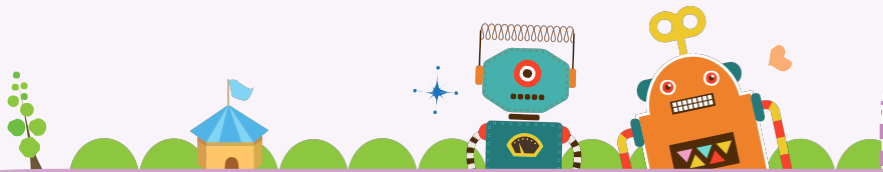

5

Детали



x1



x2



x2

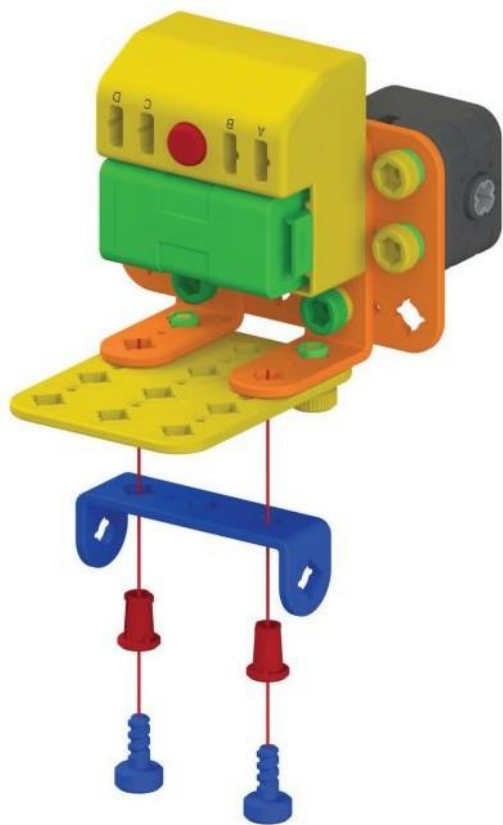

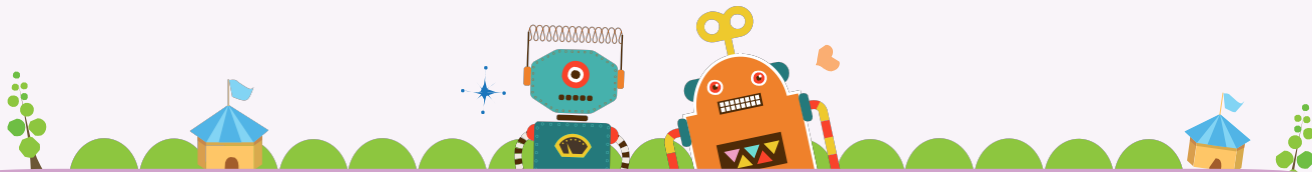

6

Детали



x1



x2



x2

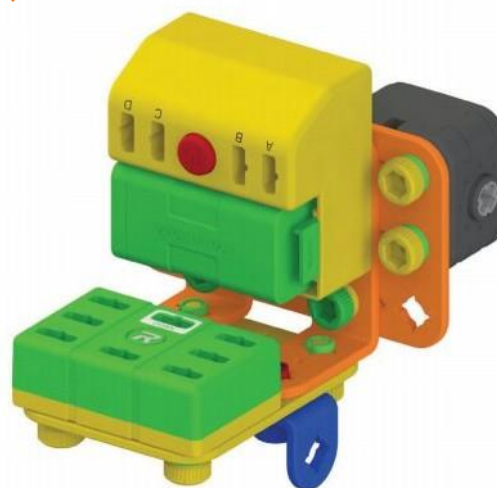
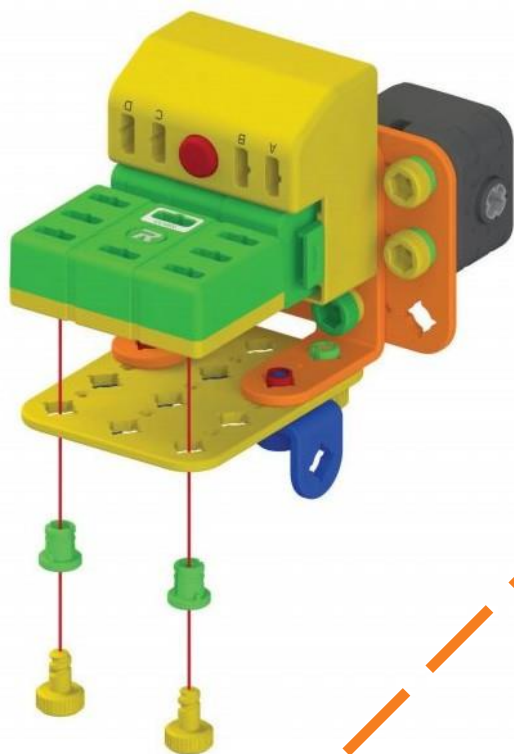



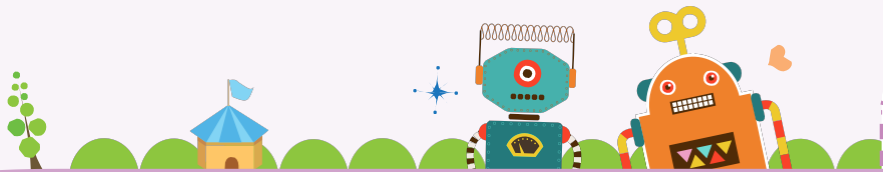

Детали



x2



x2



x2

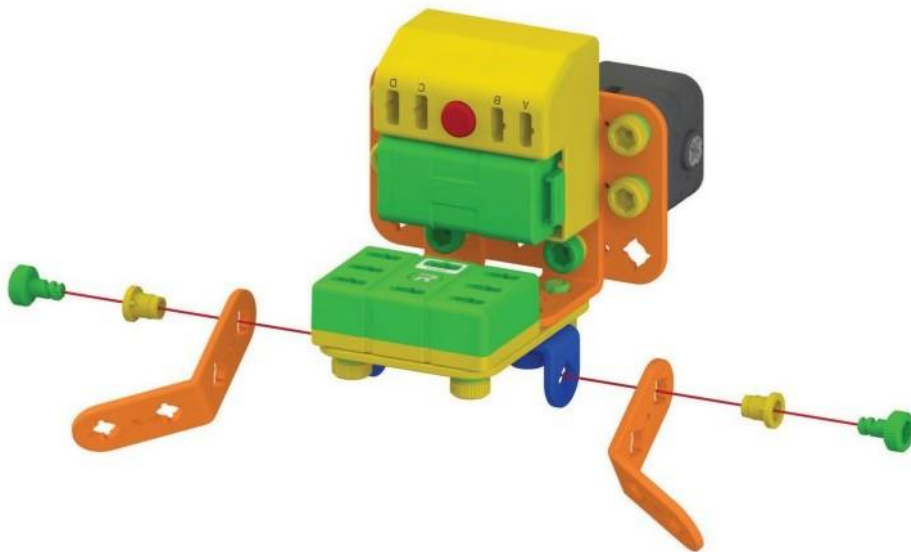

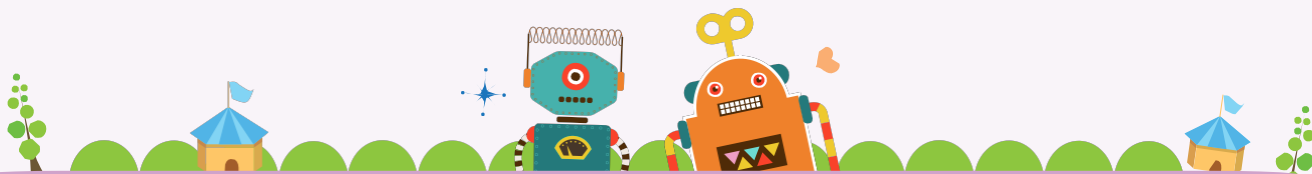

8

Детали



x2



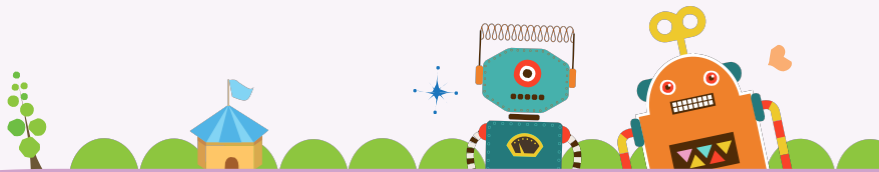

9

Детали



x2



x2



x2



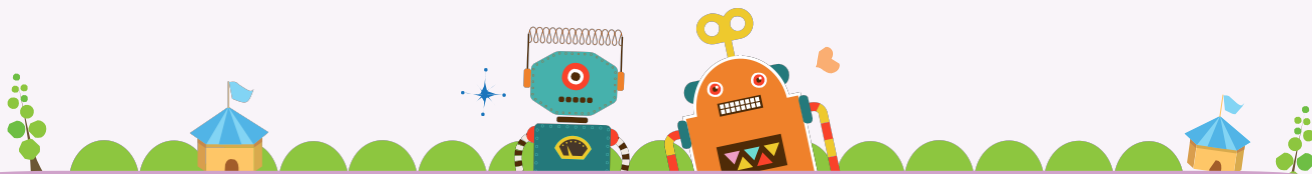

10

Детали



x2



x2



x1



x1



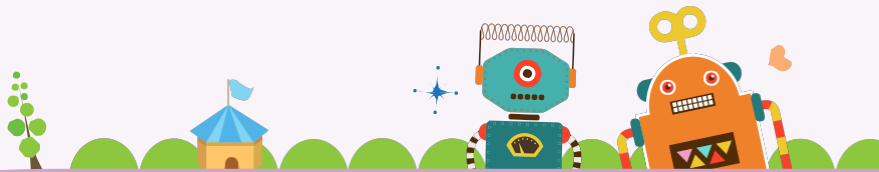

Детали



x2



x2



x2

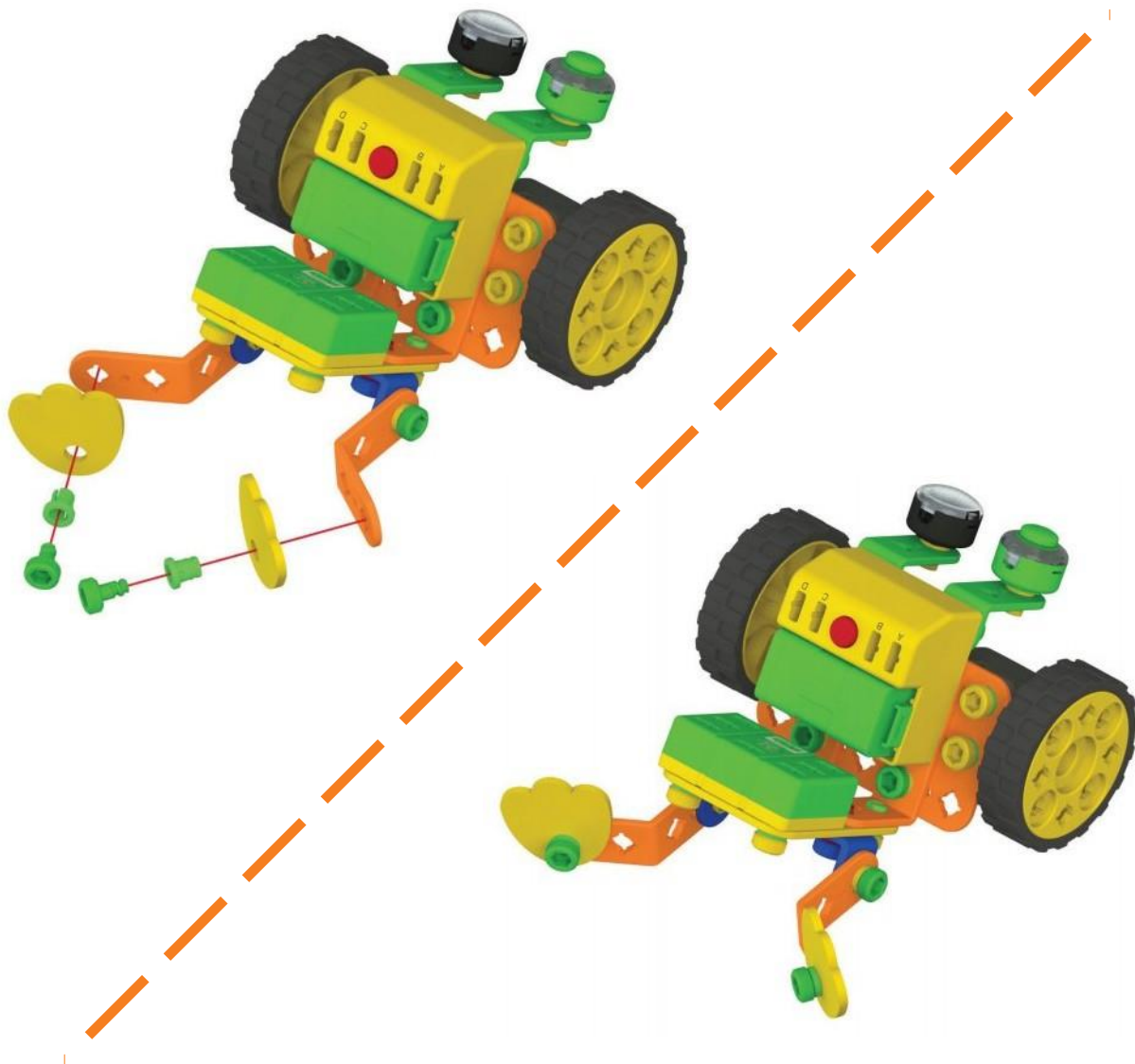

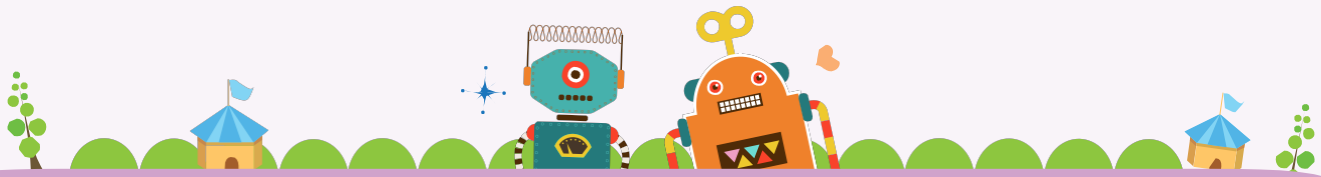

Правый электромотор  
Подключите к В

Левый электромотор  
Подключите к А

Двухсторонний кабель  
Подключите к порту D и ЦП

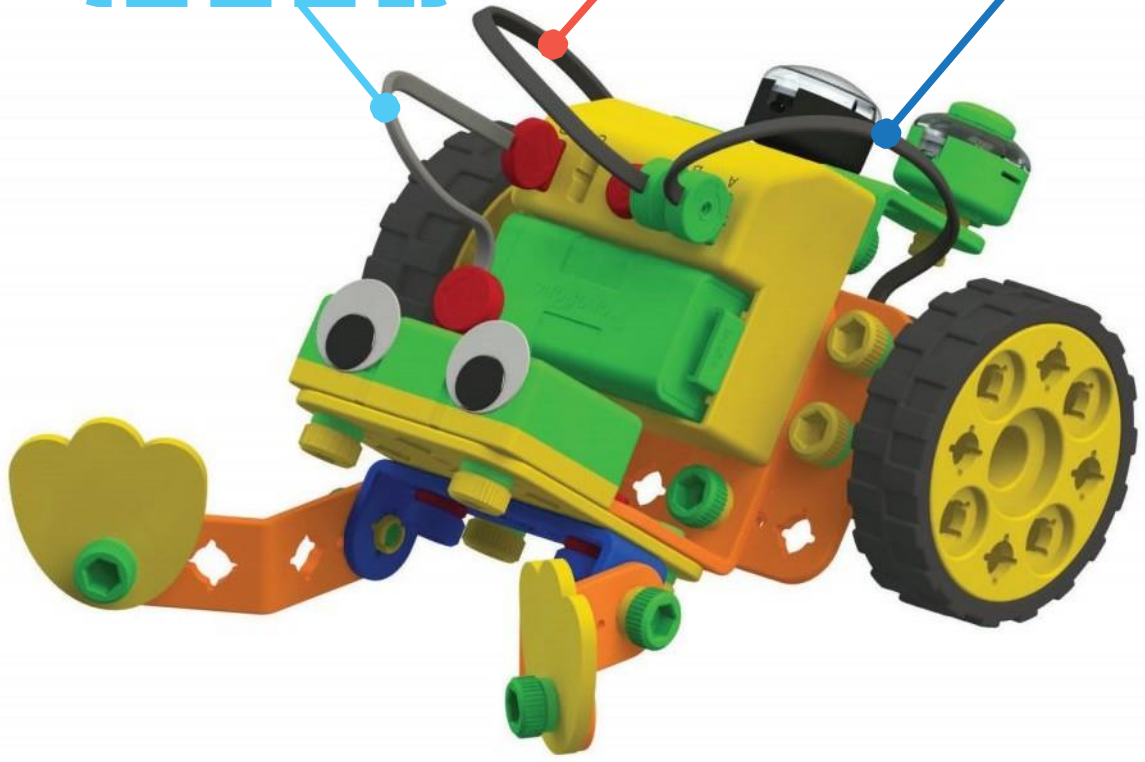



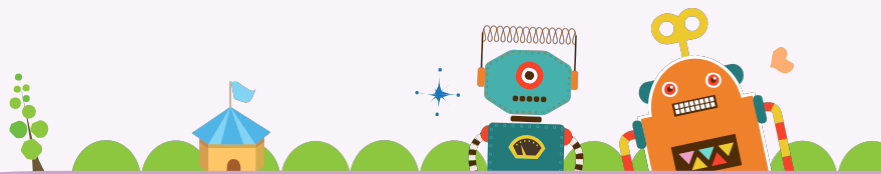

## Робот-футболист

Контактный датчик (G)  
Подключите к ЦП

Плата дистанционного  
приемника  
Подключите к ЦП

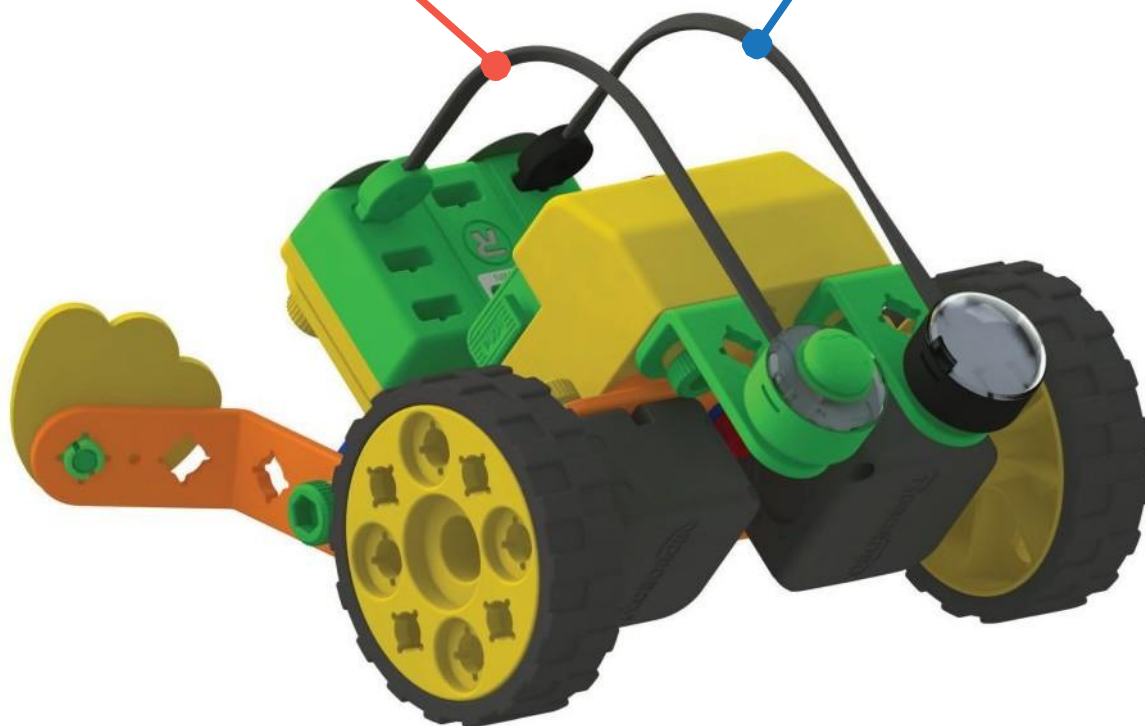



Запрограммируем движение робота футболиста на программной плате.

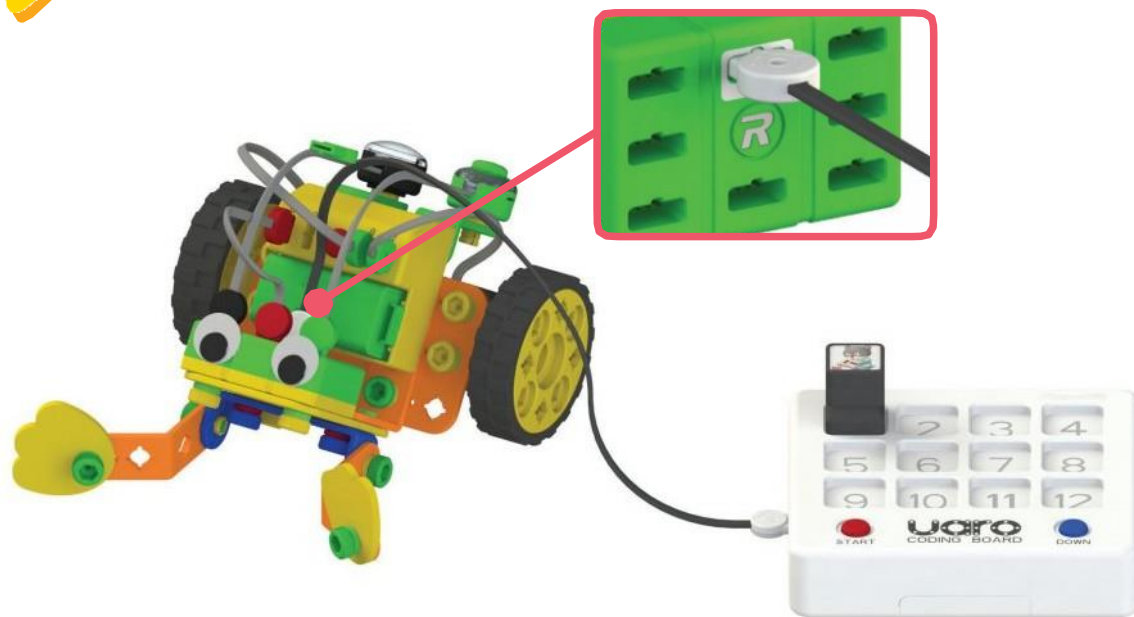

Управляйте роботом футболистом с помощью устройства дистанционного управления

4-й



Познакомимся с роботом-быком



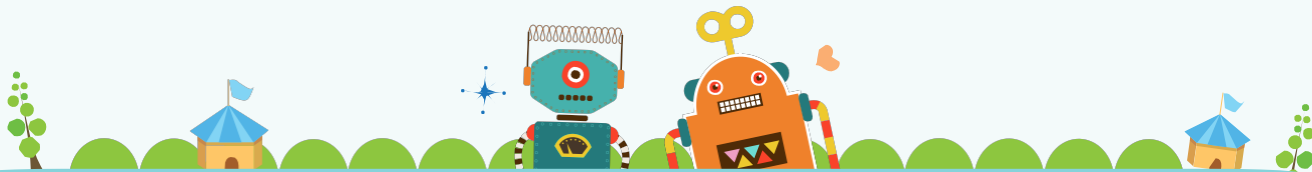

Детали



x2



x1



x4



x4

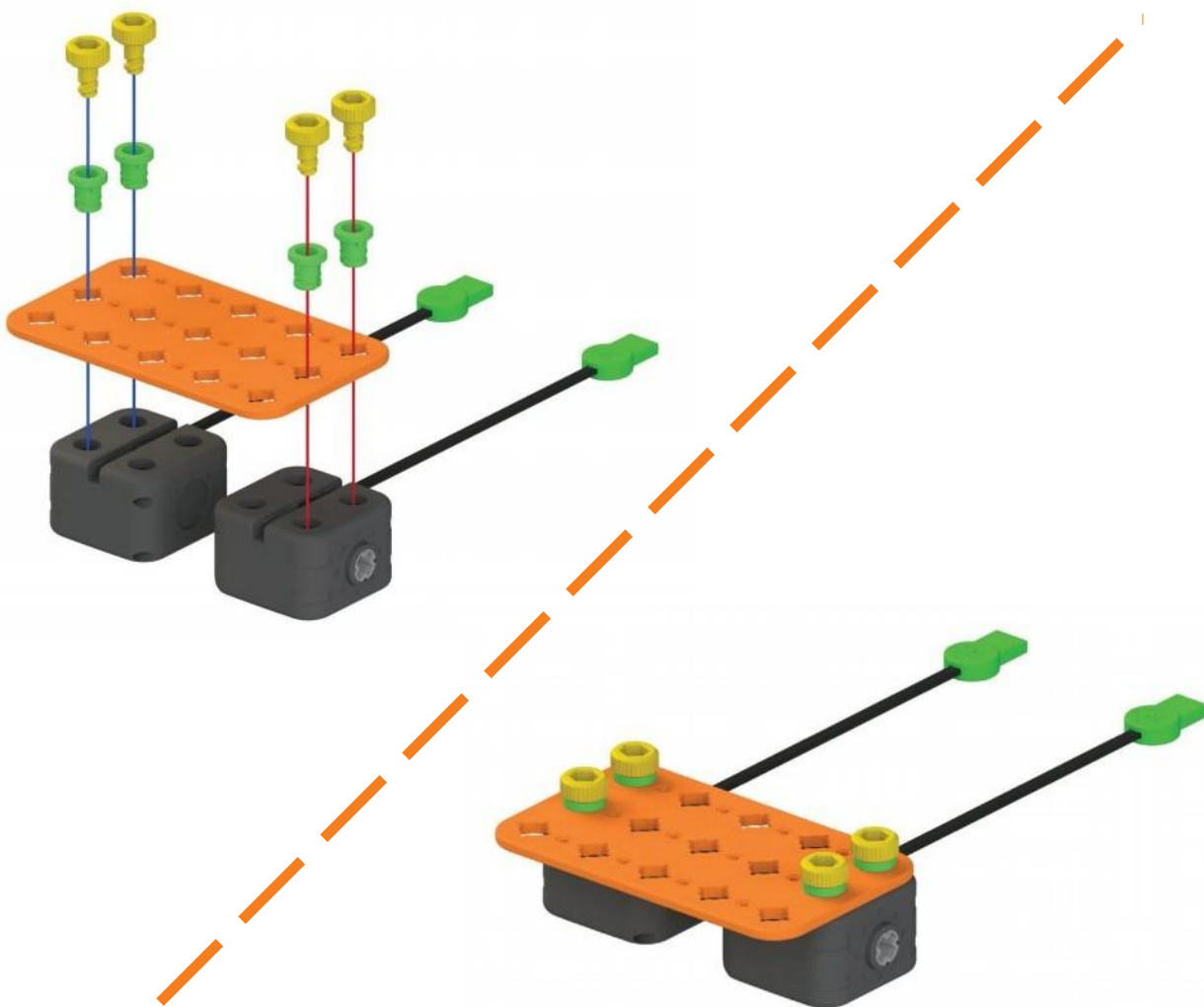

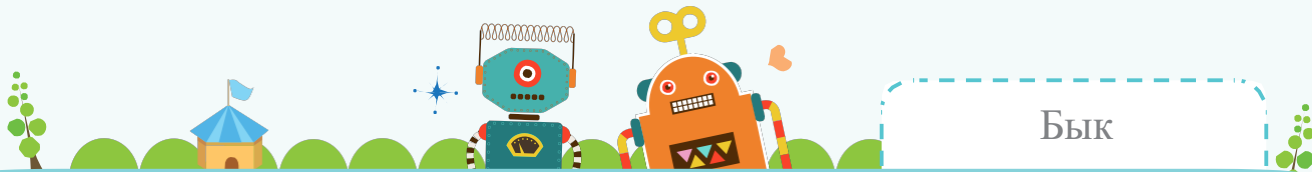

2 Детали



x1



x2



x2

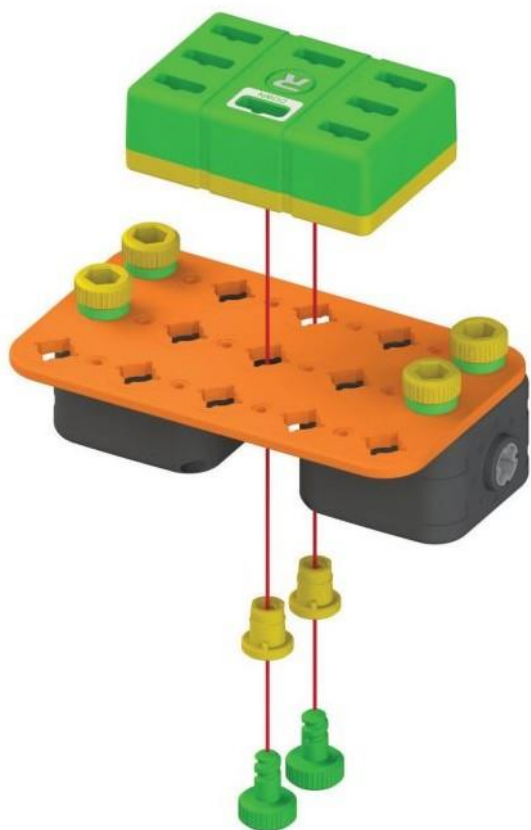

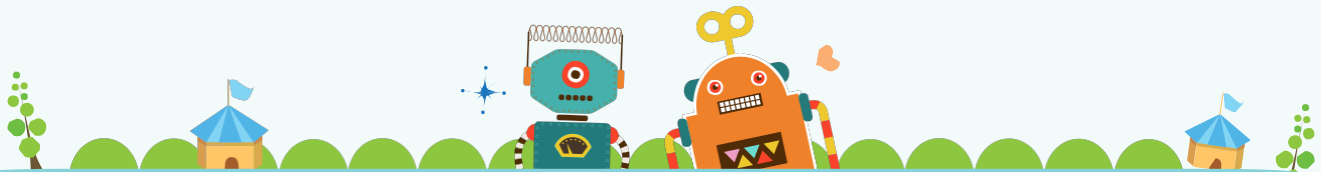

3

Детали



x1



x2



x2

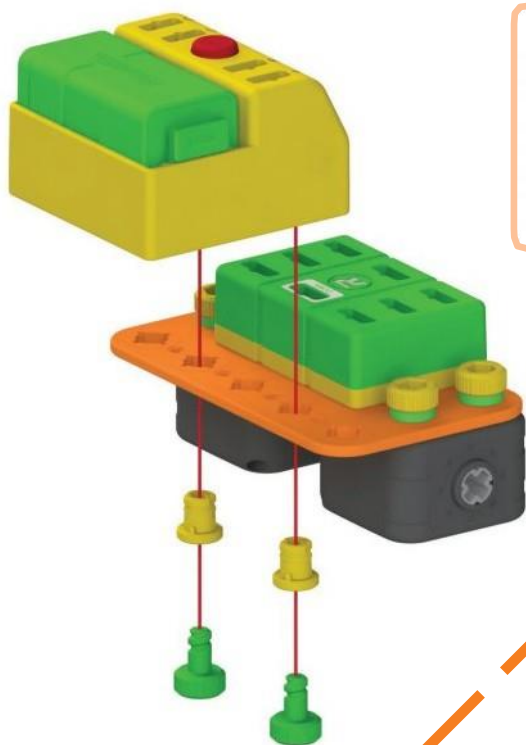



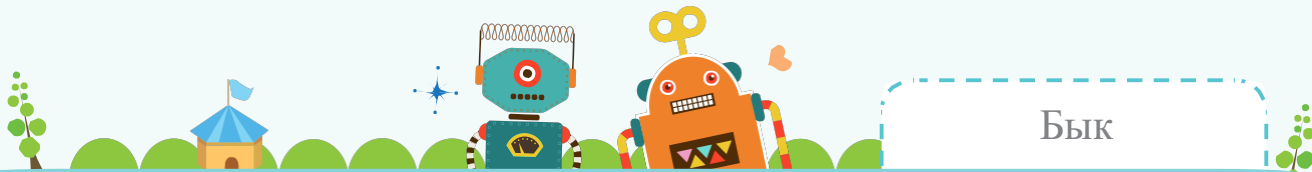

4 Детали



x1



x2



x2

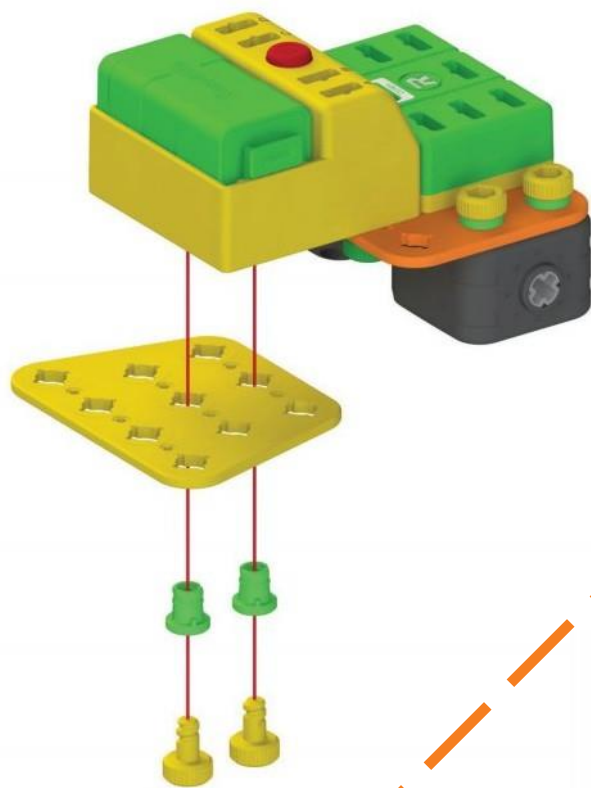

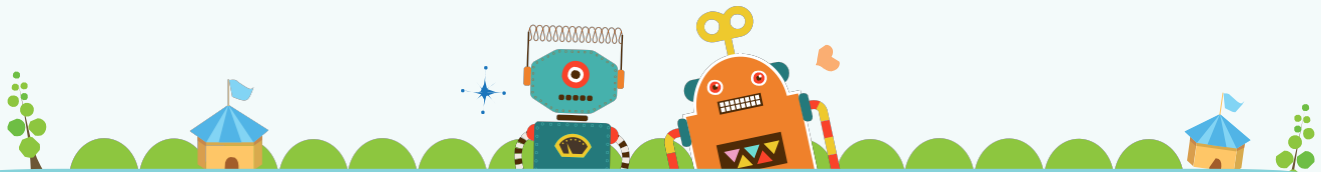

5

Детали



x2



x2



x2

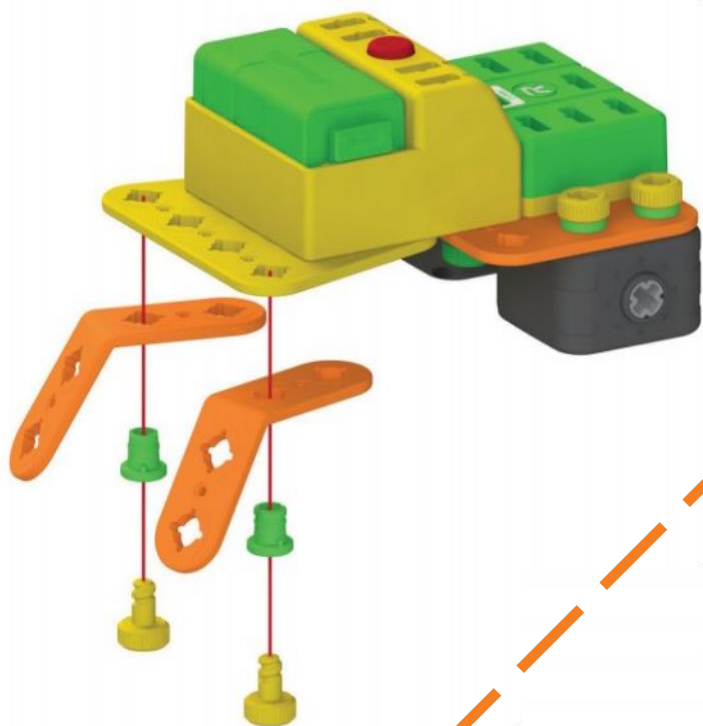

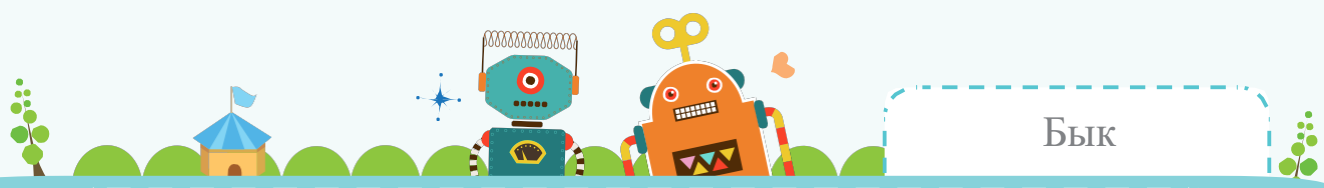

6 Детали

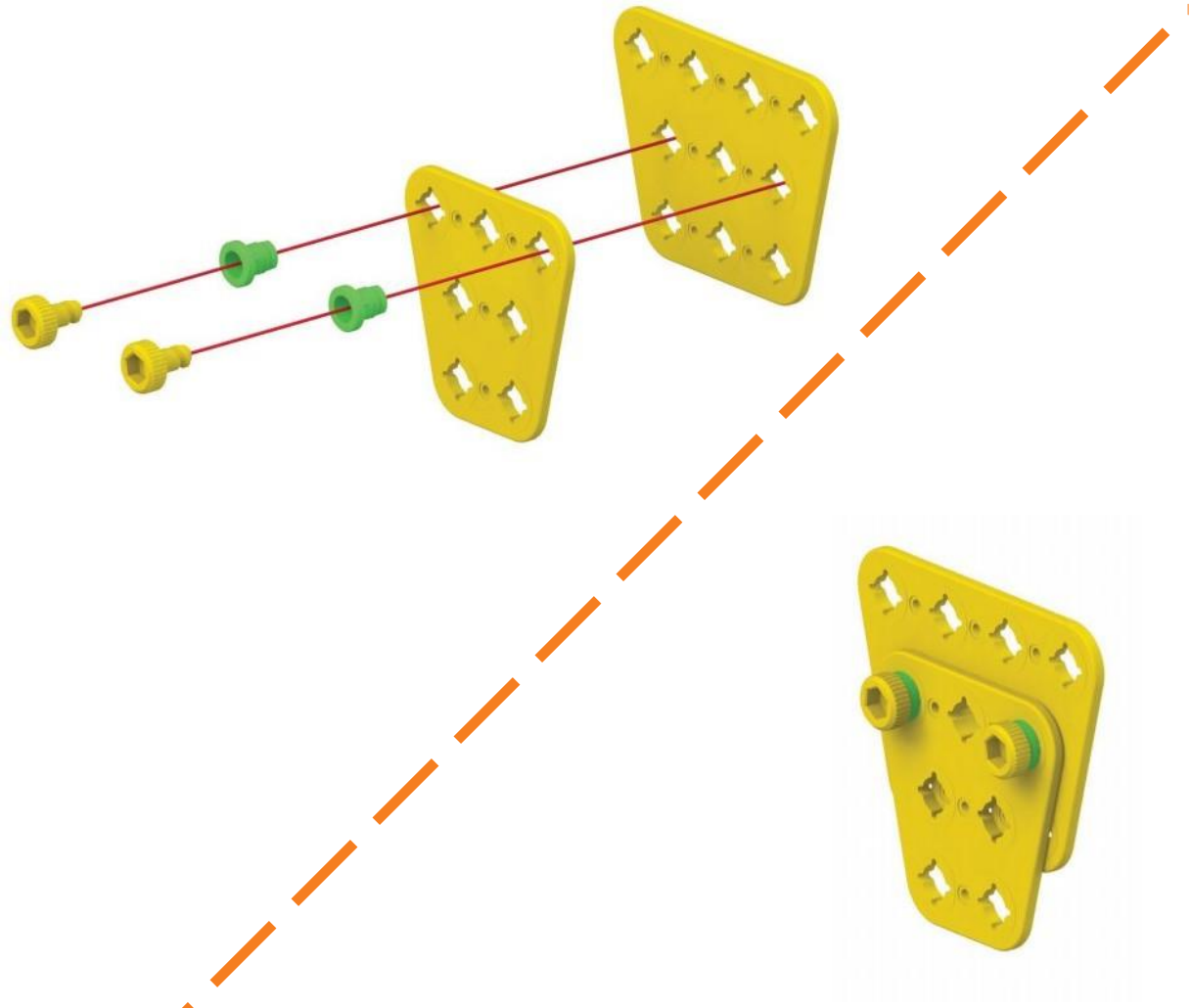
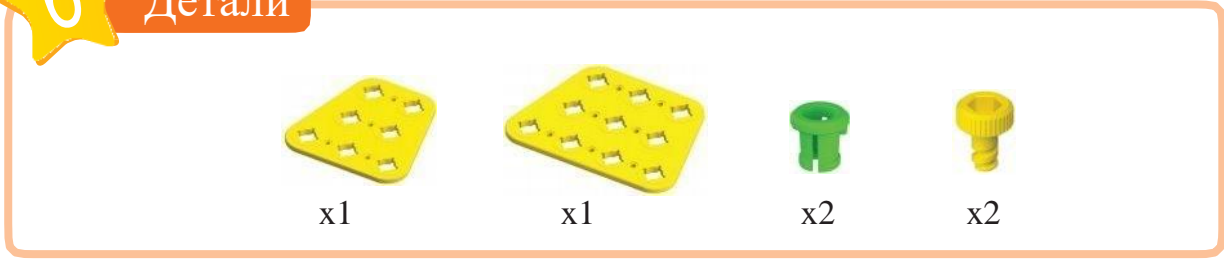

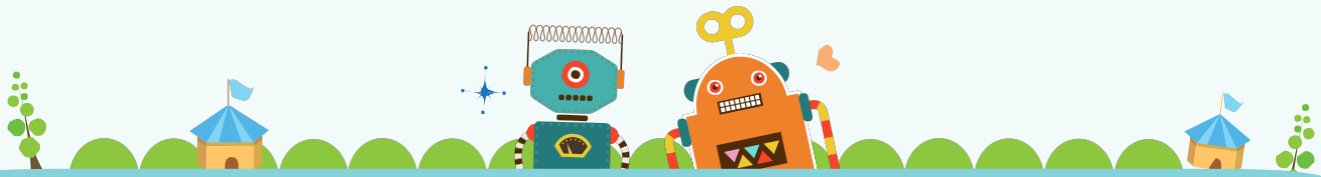

Детали



x2



x2



x2

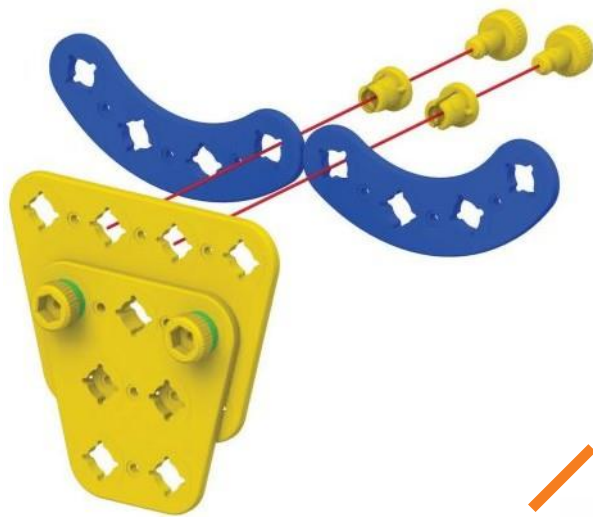

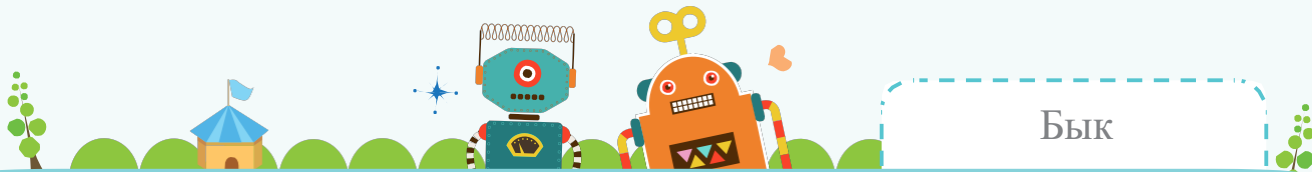

Бык



Детали



x2



x2



x4



x4

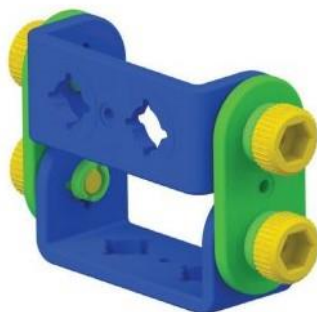
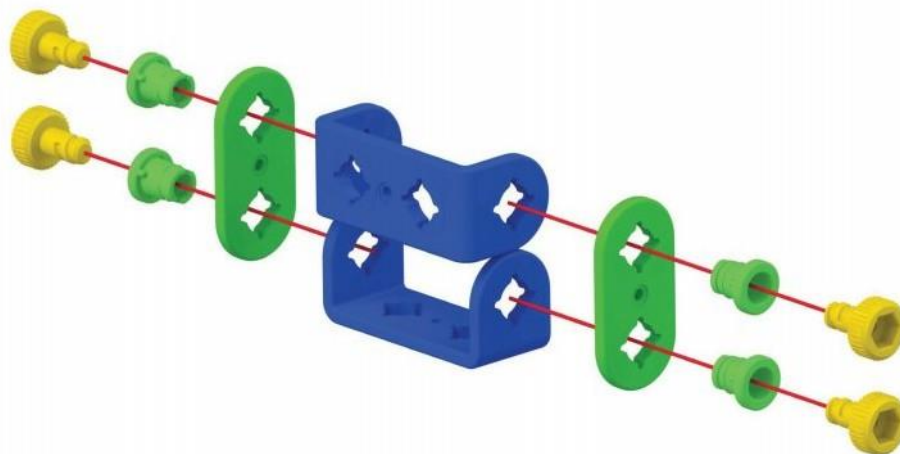

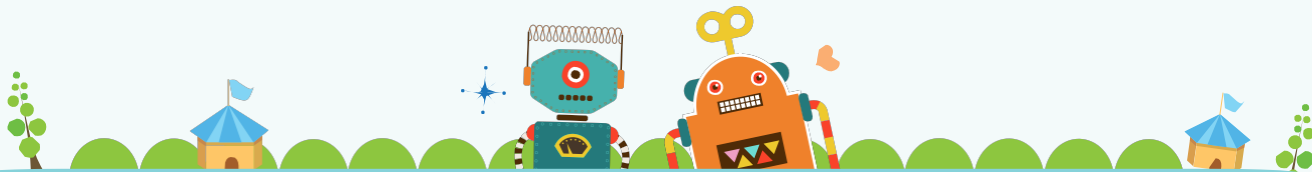

9

Детали



x2



x2

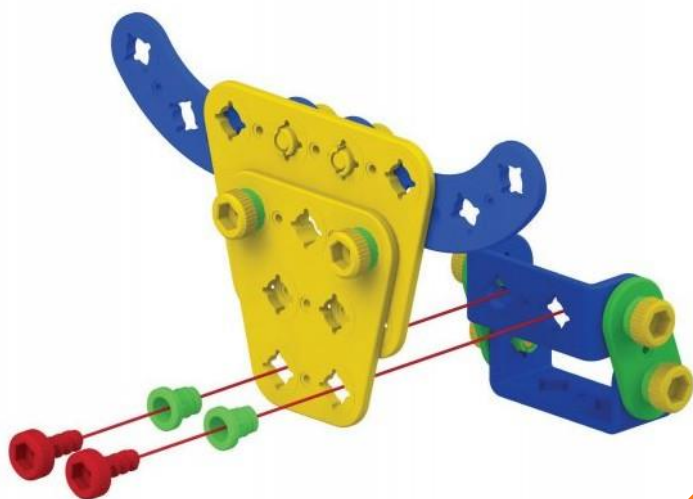



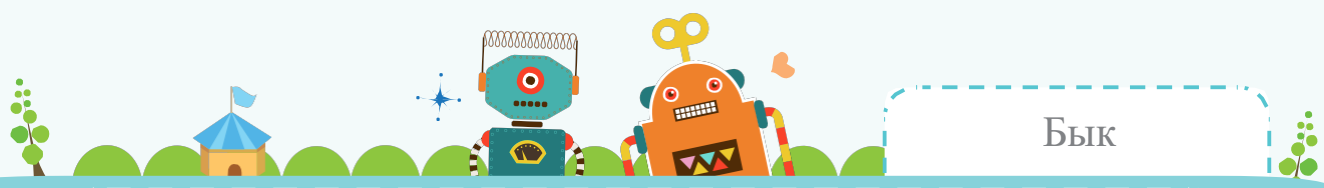

10

Детали



x2



x2



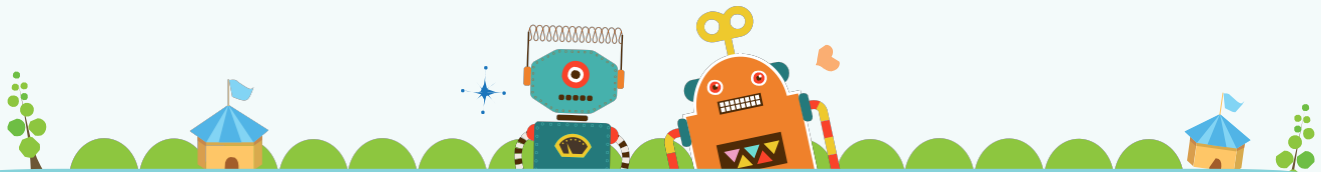

Детали



x2

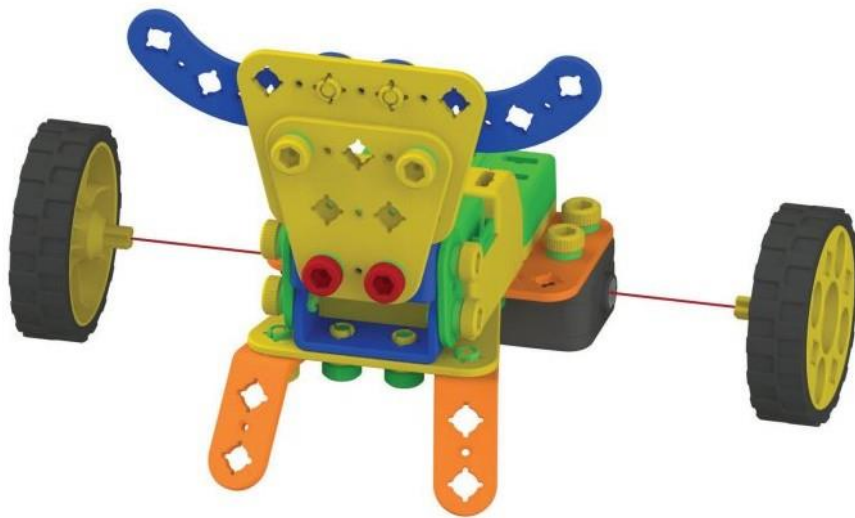

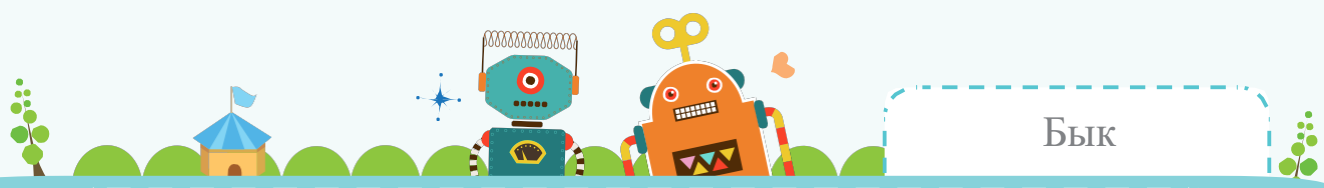

12

Детали



x2



x2



x2



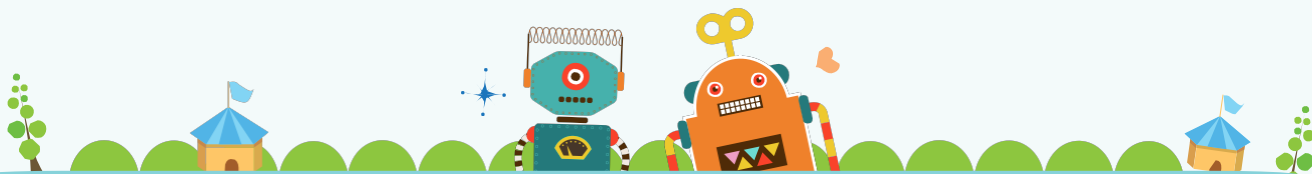

13

Детали



x1



x1



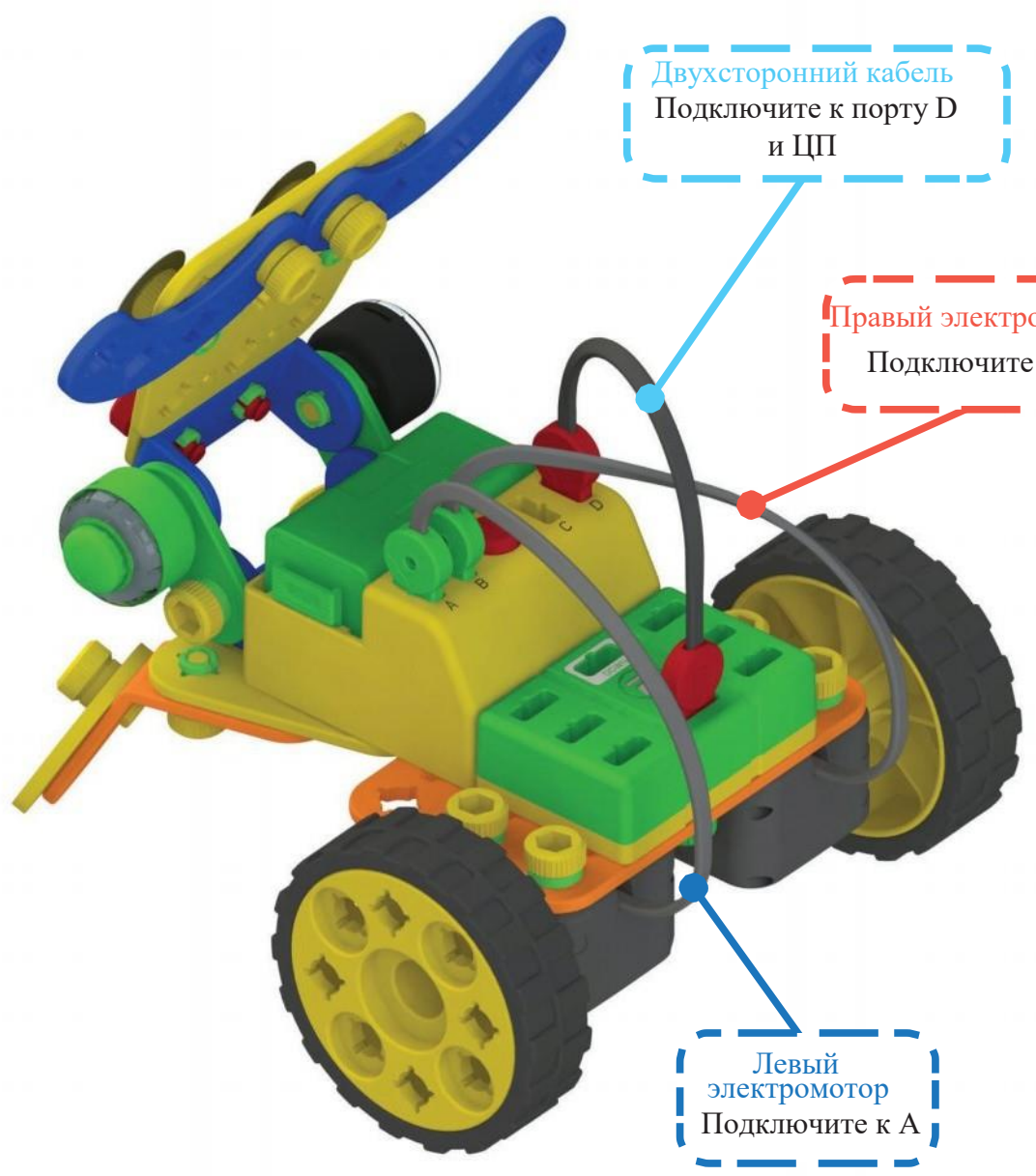
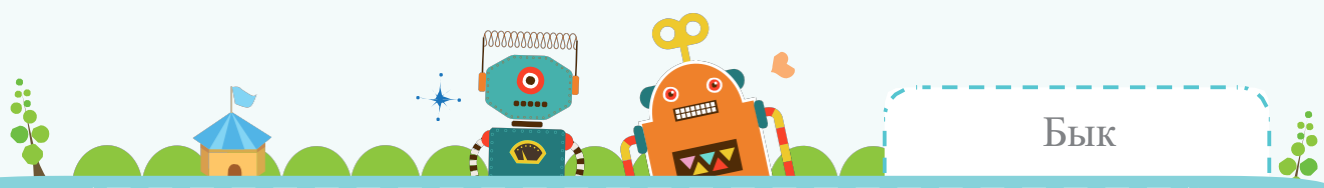



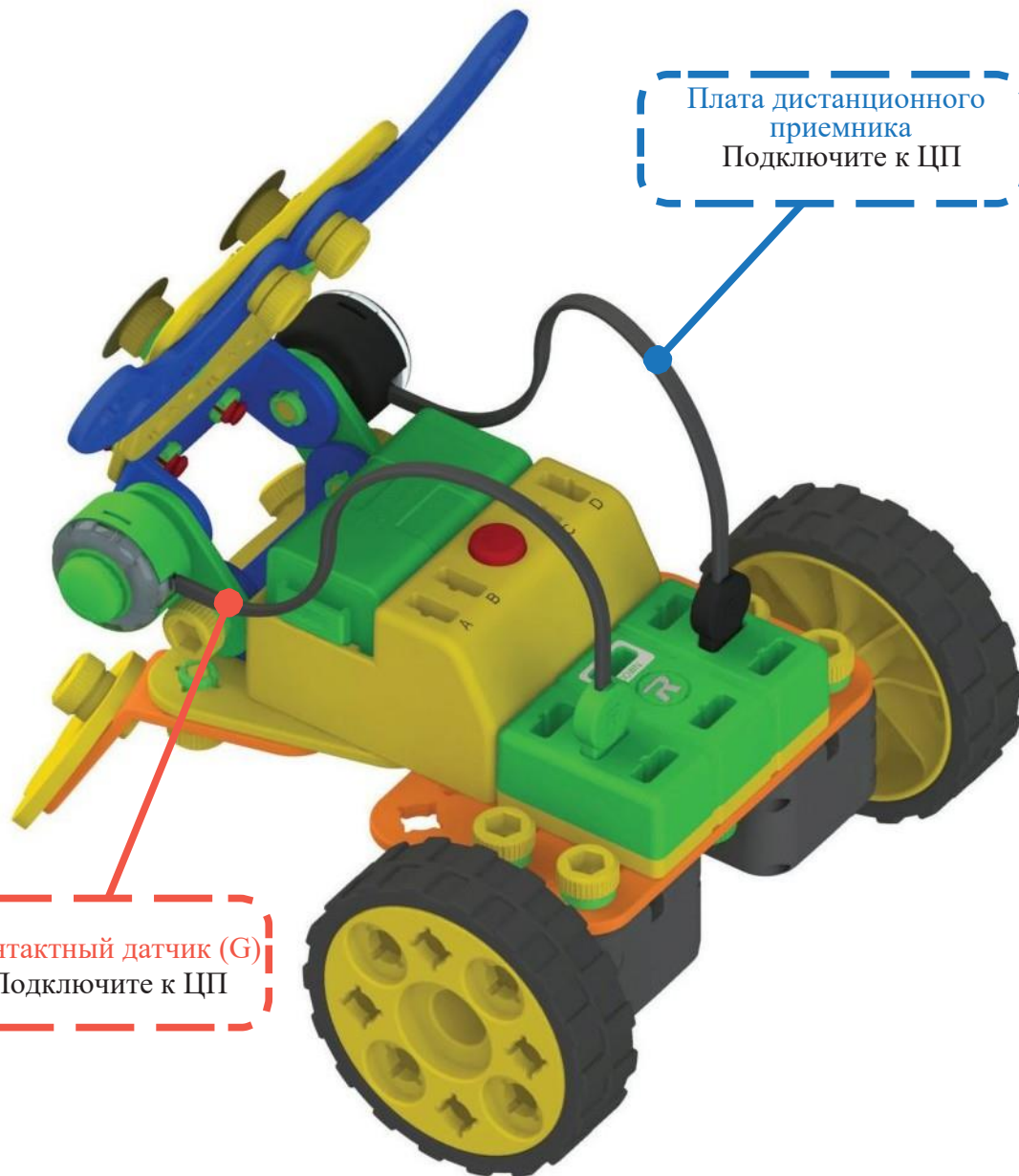
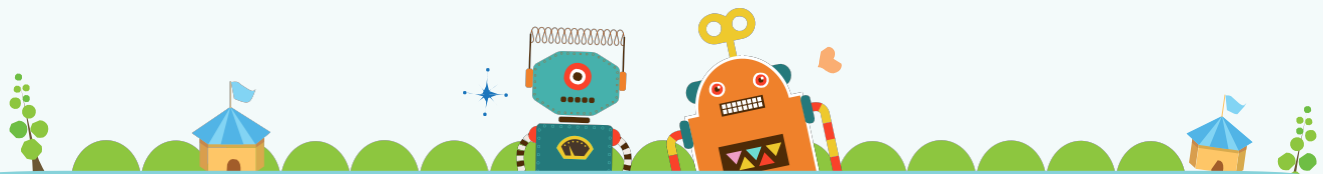

Контактный датчик (G)  
Подключите к ЦП

Плата дистанционного  
приемника  
Подключите к ЦП



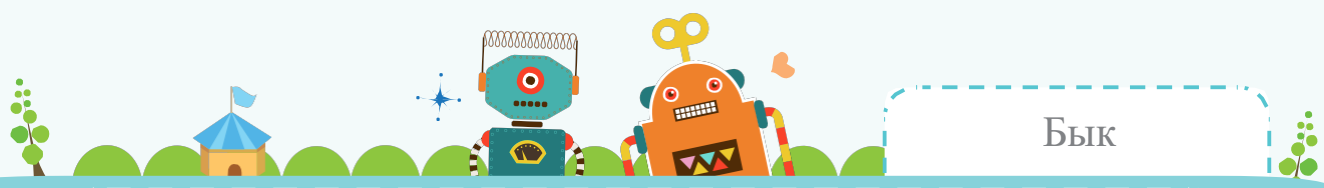

Создадим Программу

Запрограммируем движение робота-быка на программной плате.

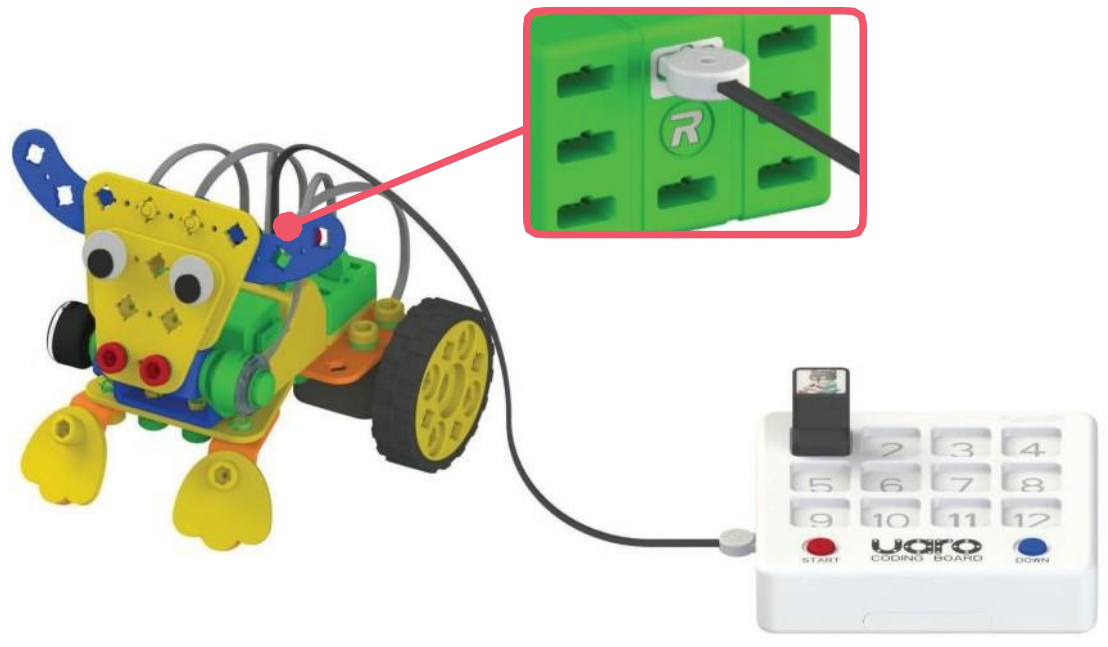

Управляйте роботом-быком с помощью устройства дистанционного управления



Познакомимся со стрекозой

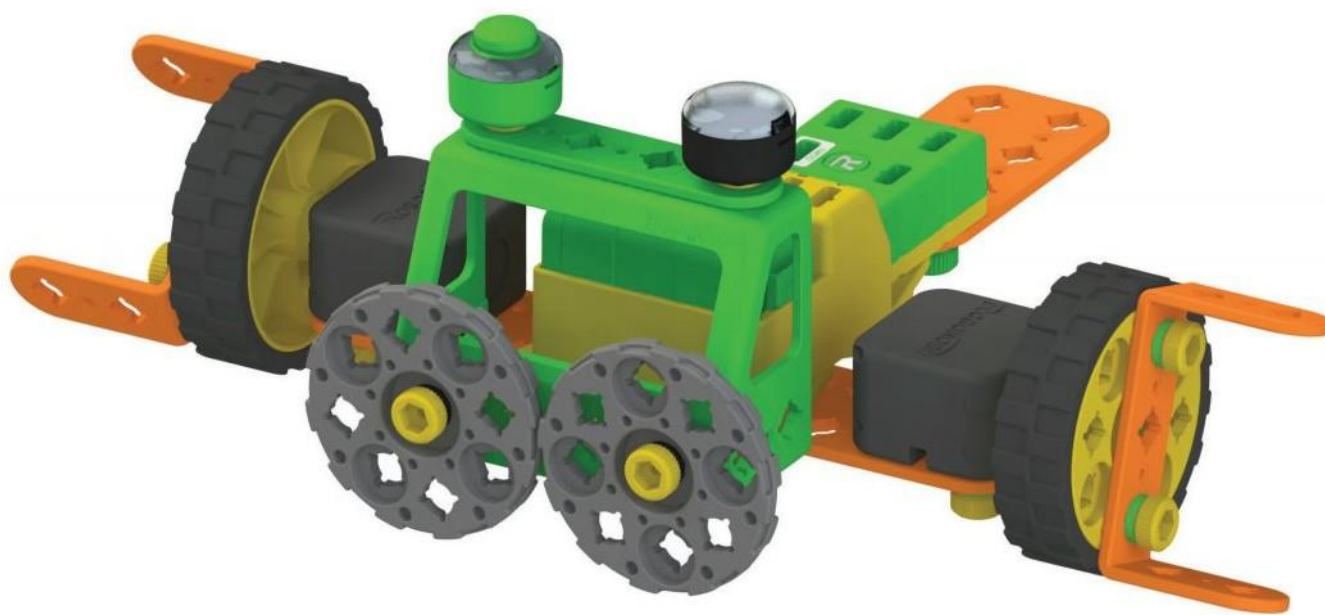

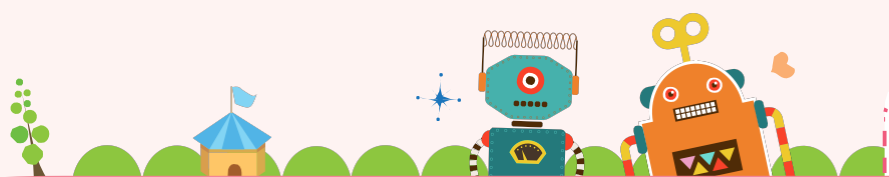

Детали



x1



x1



x1



x1

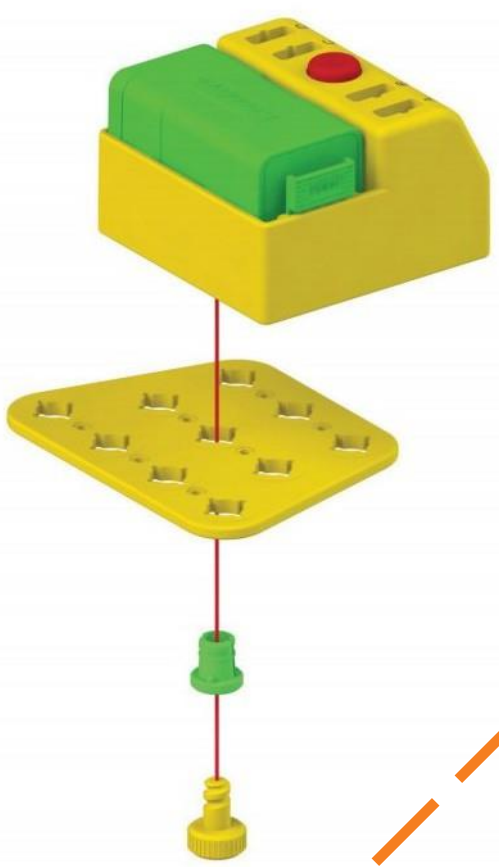

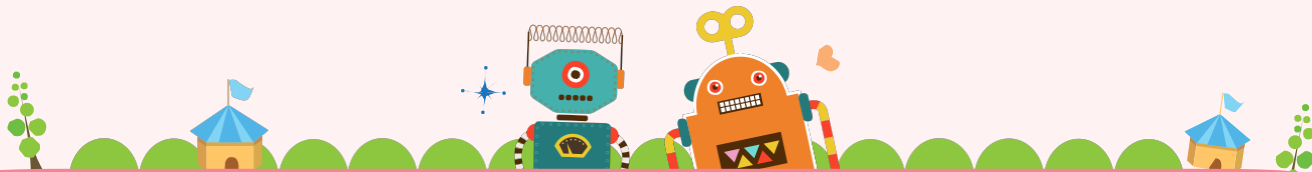

2

Детали



x2



x4



x4

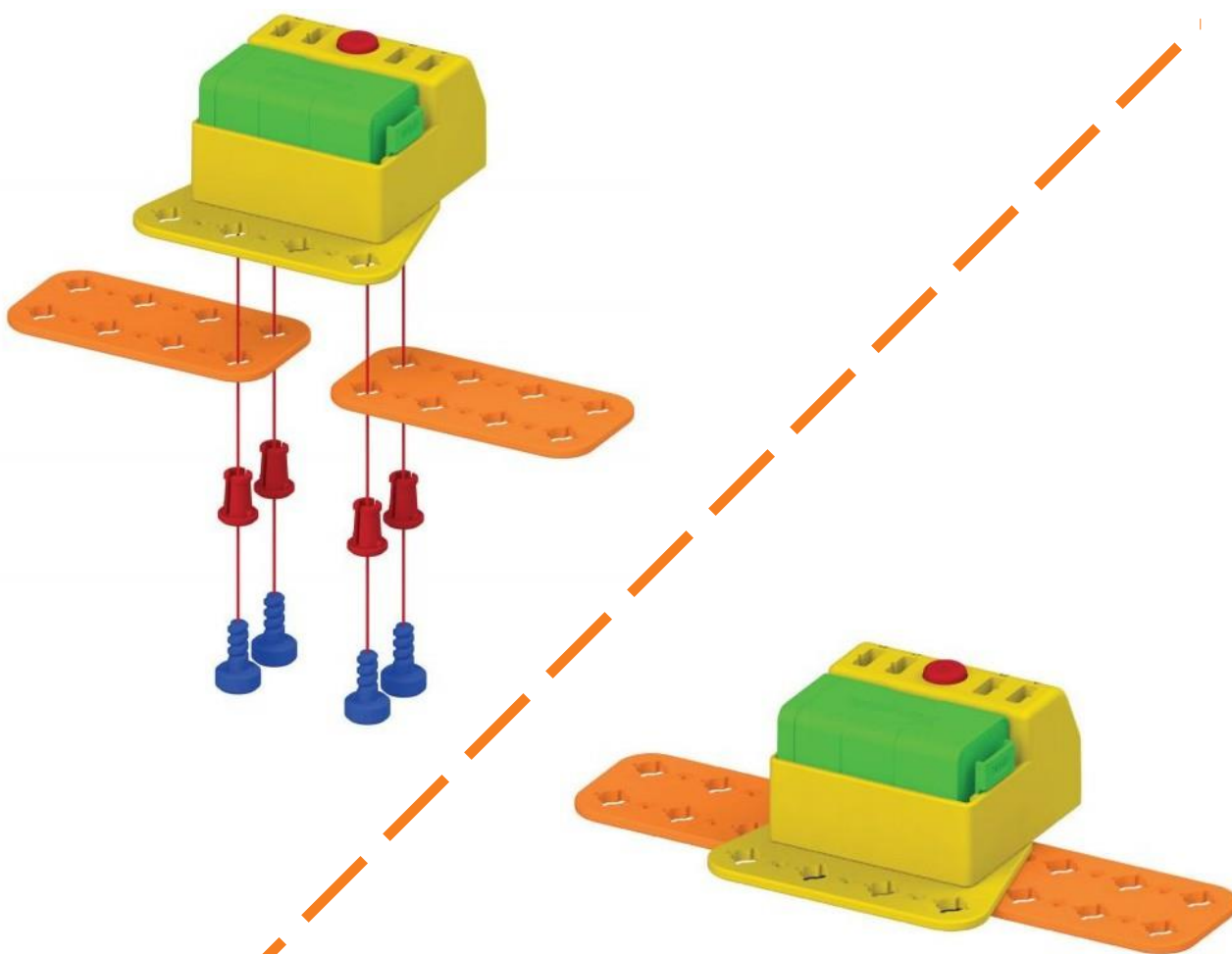

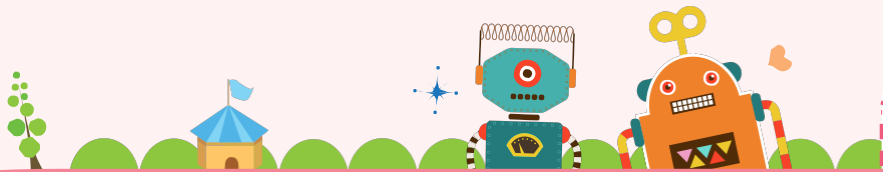

3

Детали



x1



x1



x1

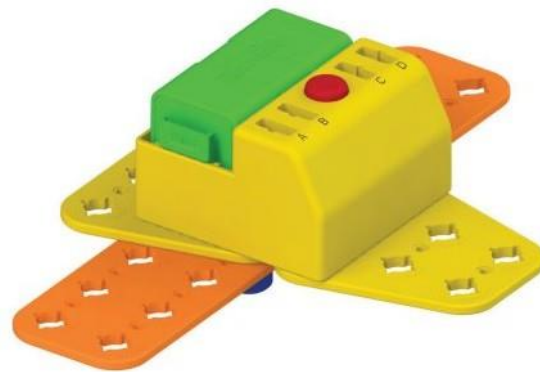
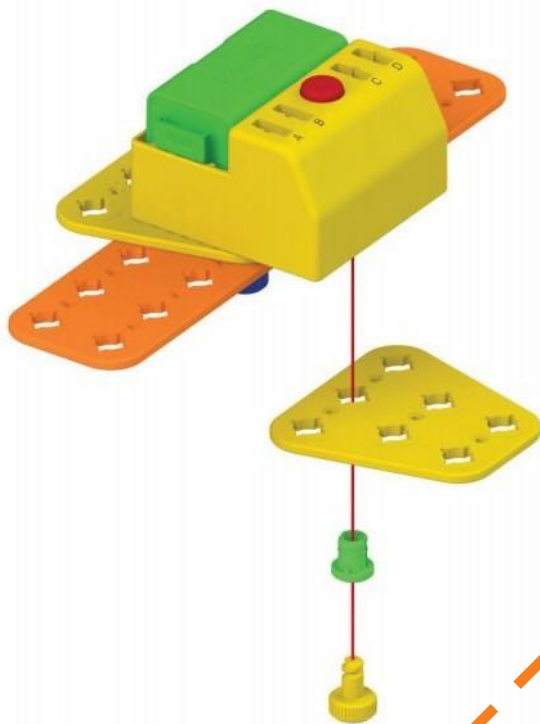

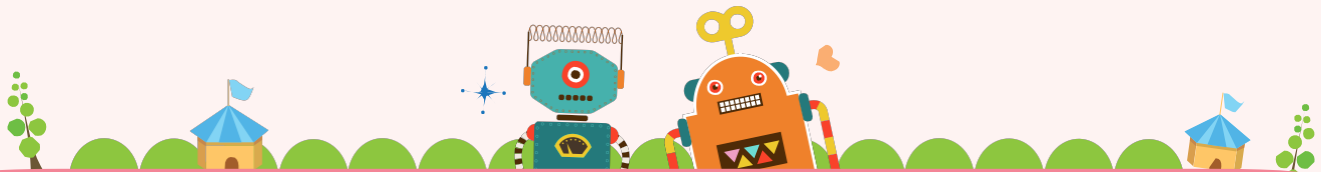

4

Детали



x1



x2



x2

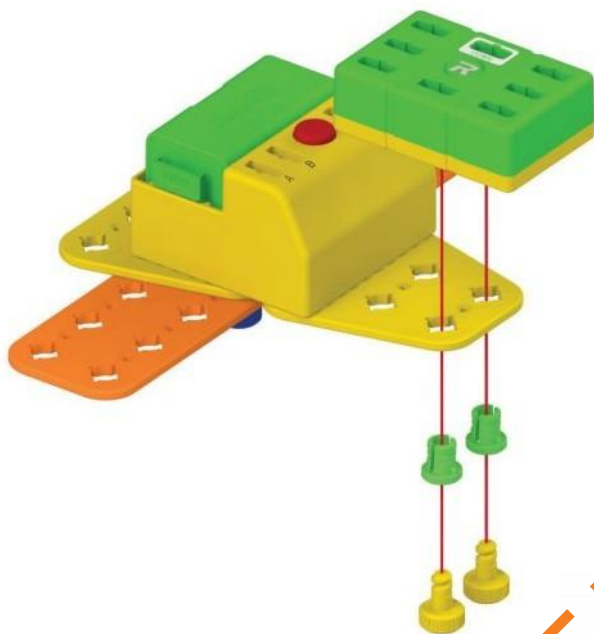



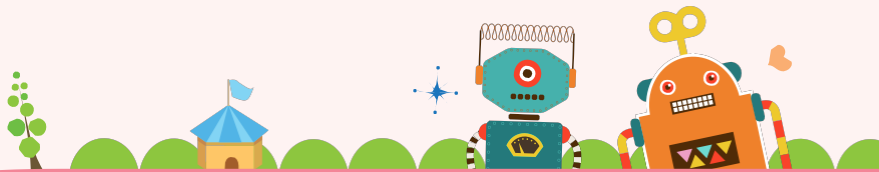

5

Детали



x1



x2



x2

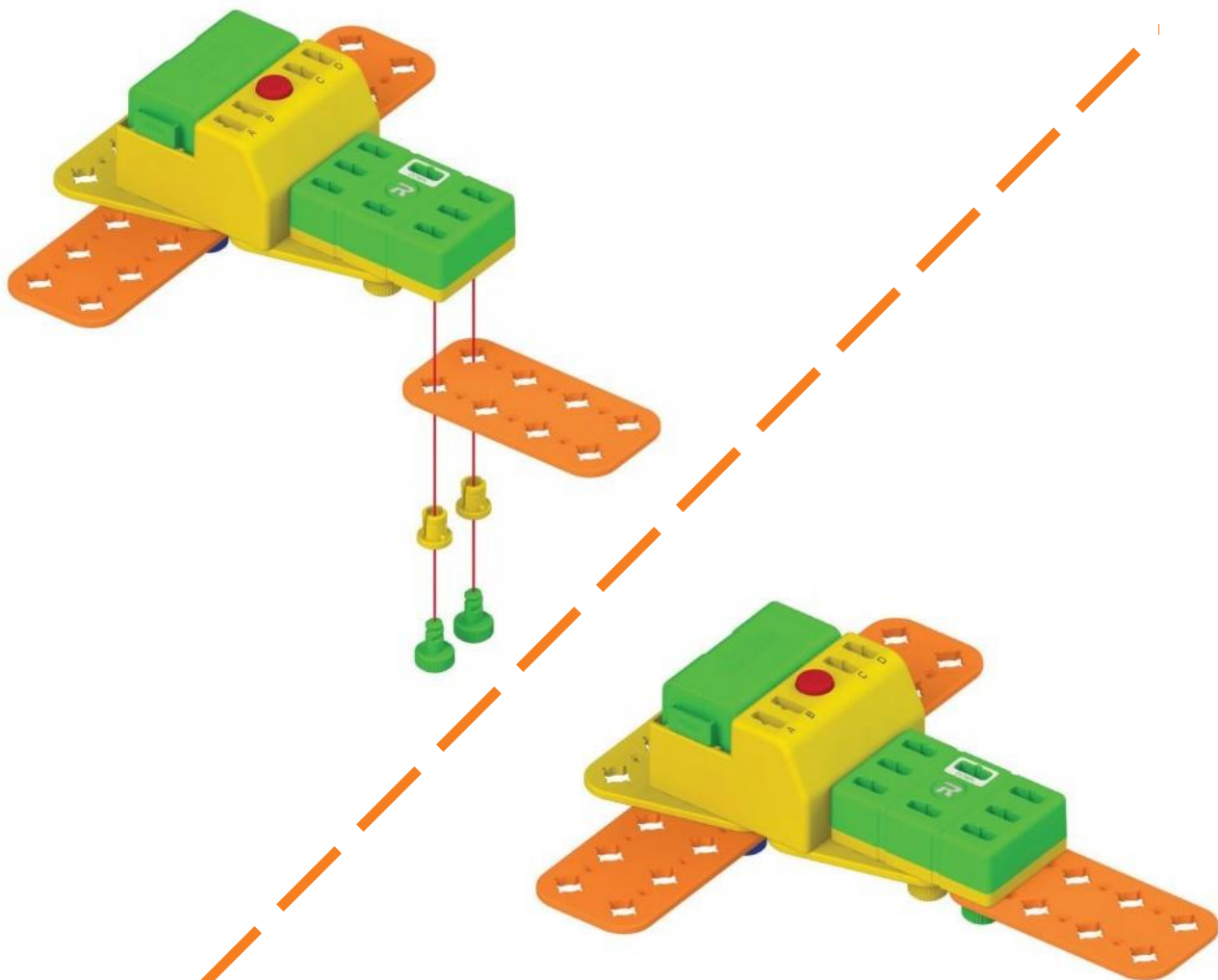

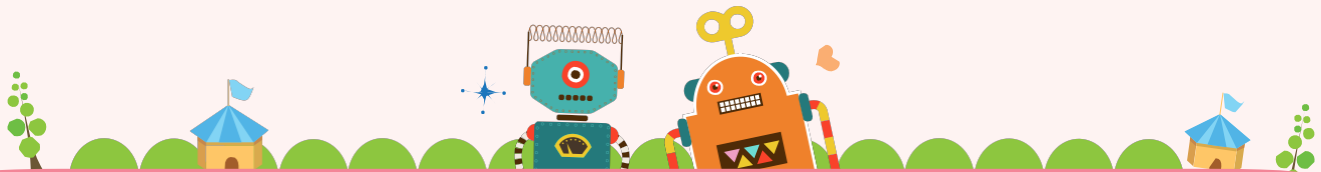

6

Детали



x2



x4



x4

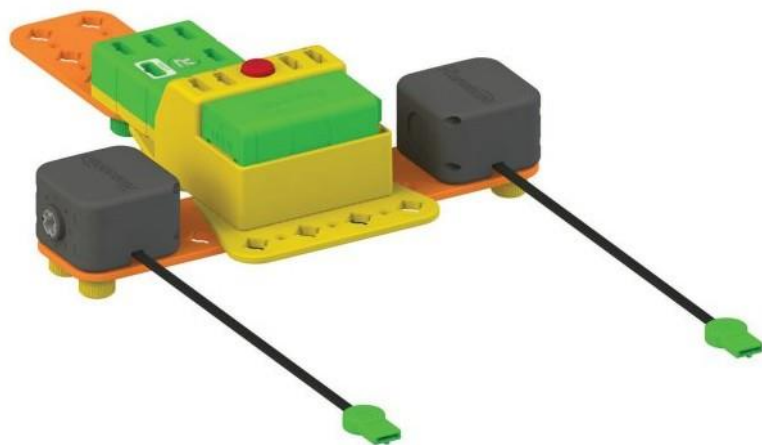
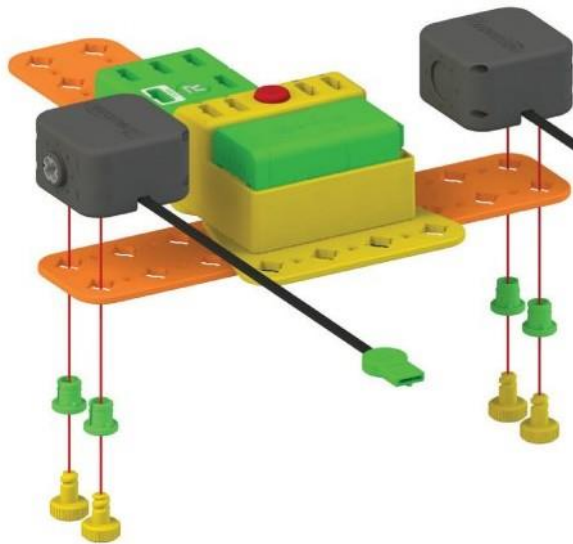

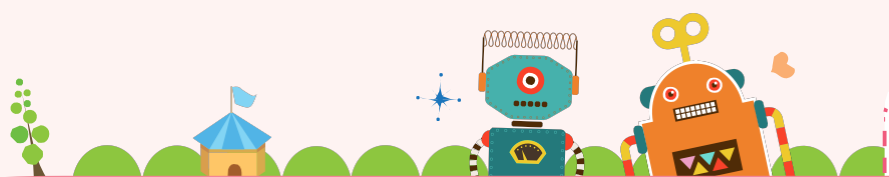

Детали



x1



x2



x2

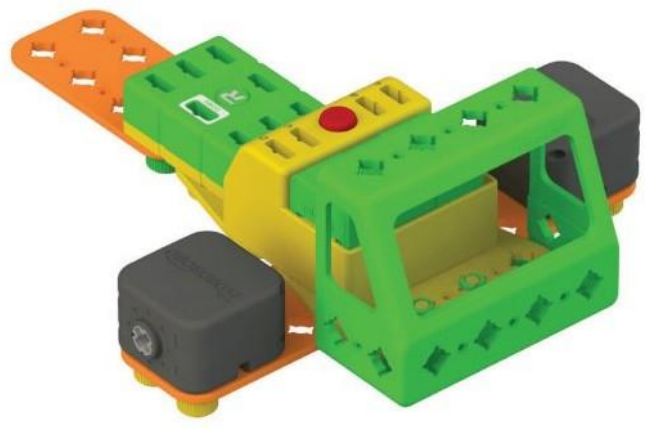
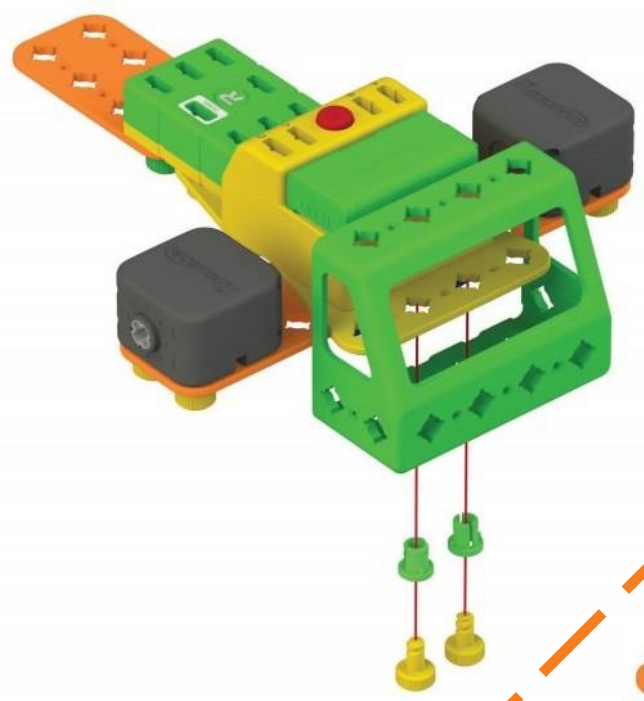

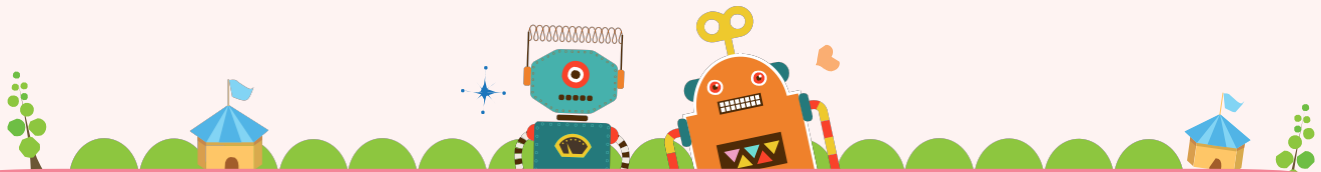

8

Детали



x2



x2



x2

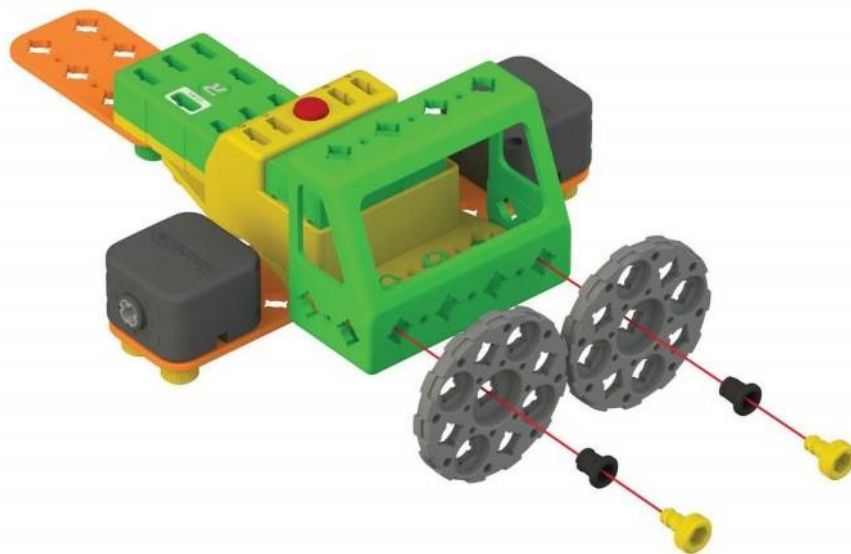

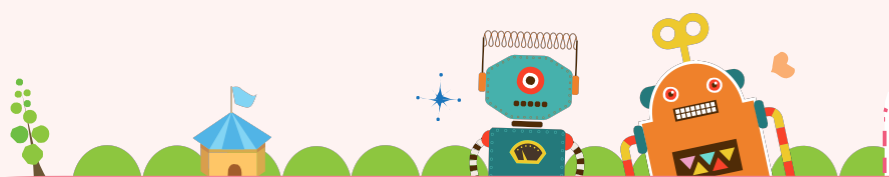

9

Детали



x2



x2



x4



x4

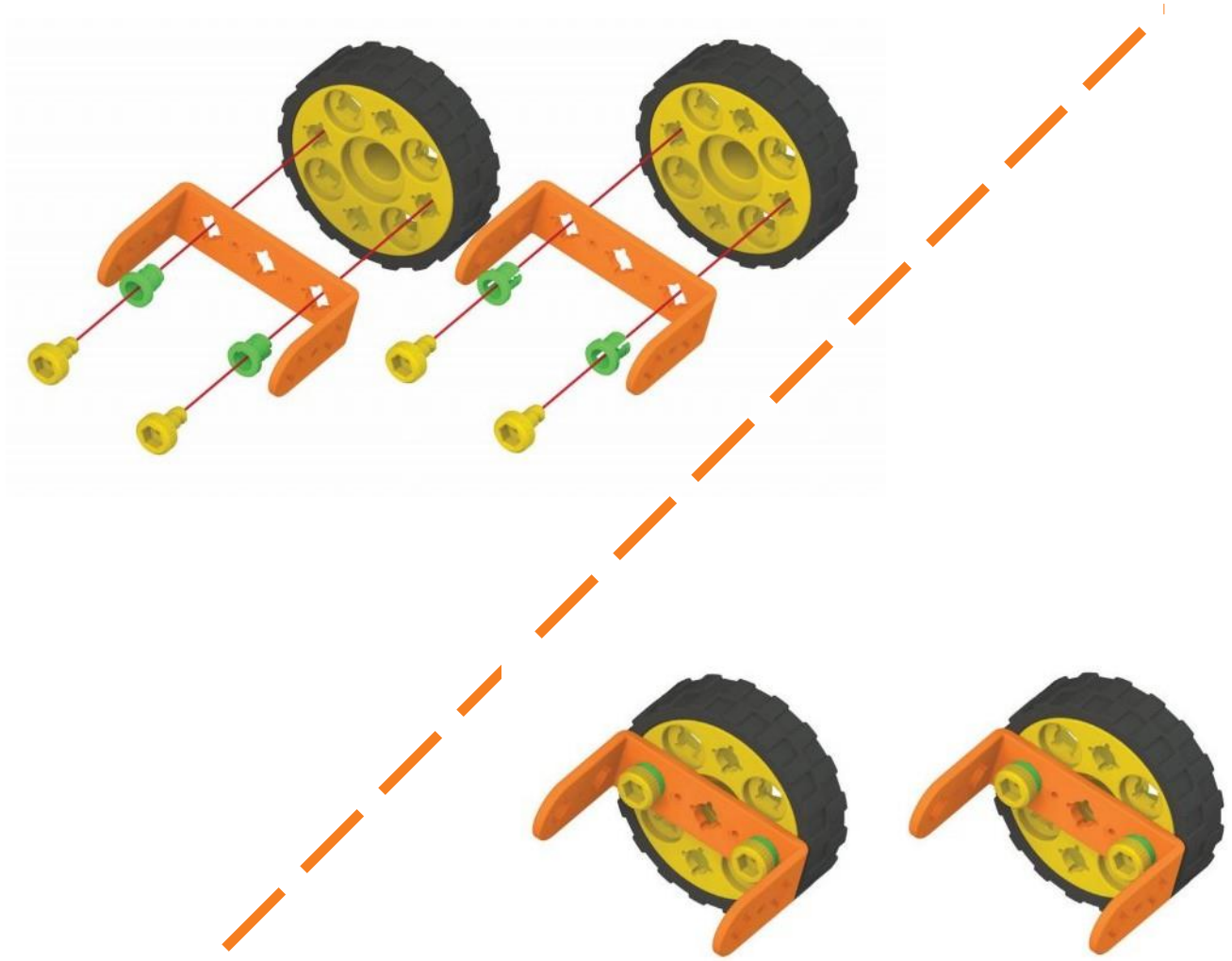

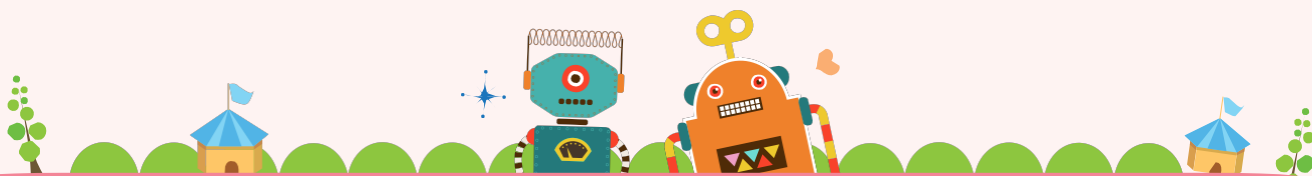

10

Детали

Продолжение Части 9





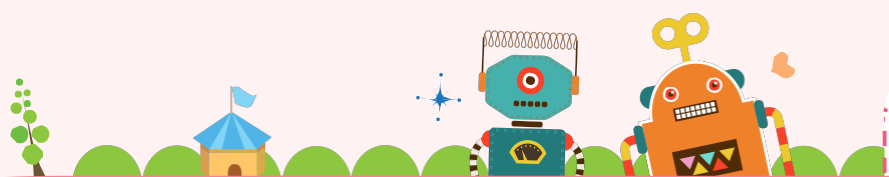

Детали

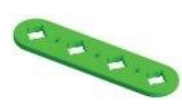

x1



x2



x2



x1



x1



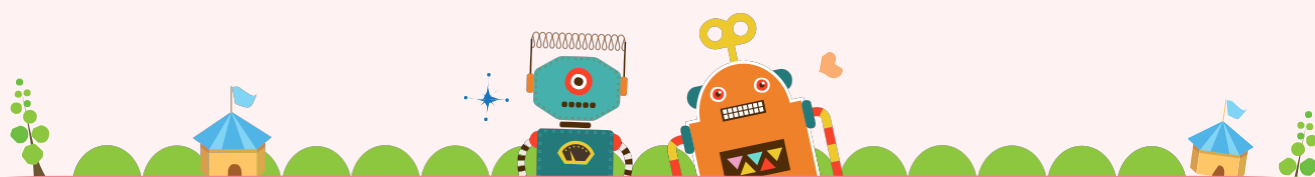

Левый  
электромотор  
Подключите к А

Правый  
электромотор  
Подключите к  
В

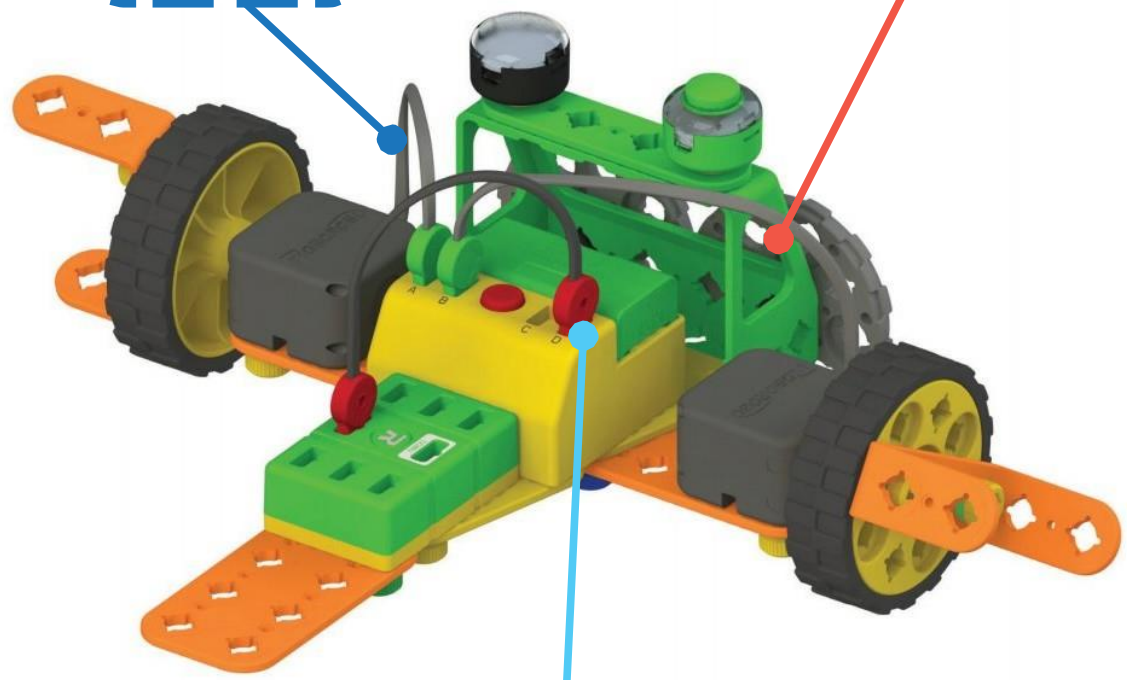

Двухсторонний кабель  
Подключите к порту D и ЦП

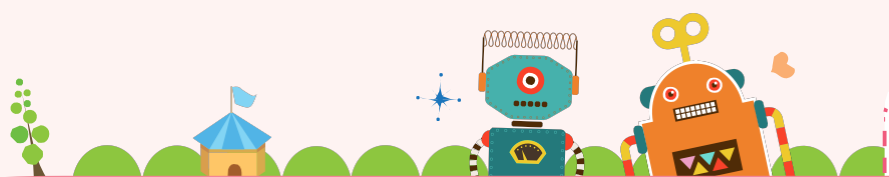

Стрекоза

Плата дистанционного приемника  
Подключите к ЦП

Контактный датчик (G)  
Подключите к ЦП

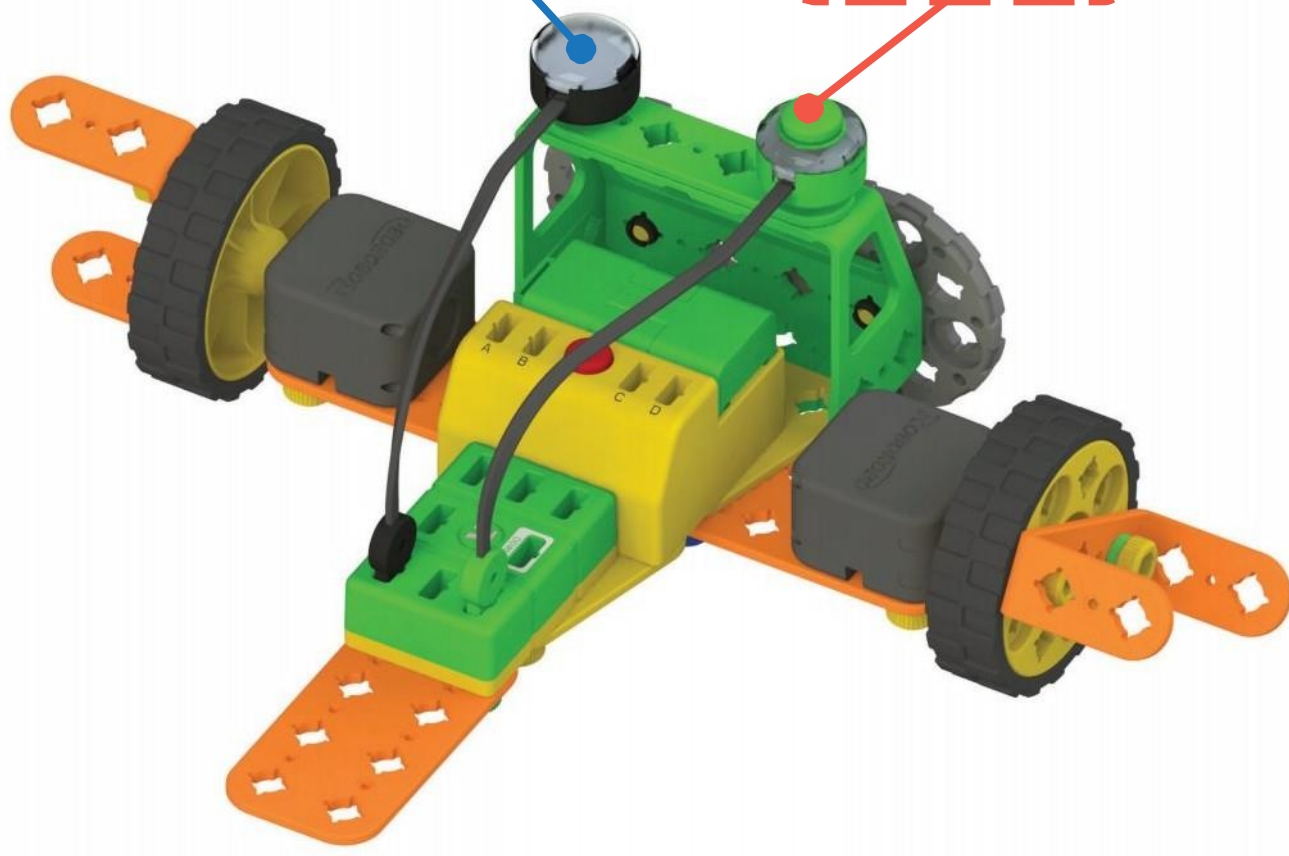

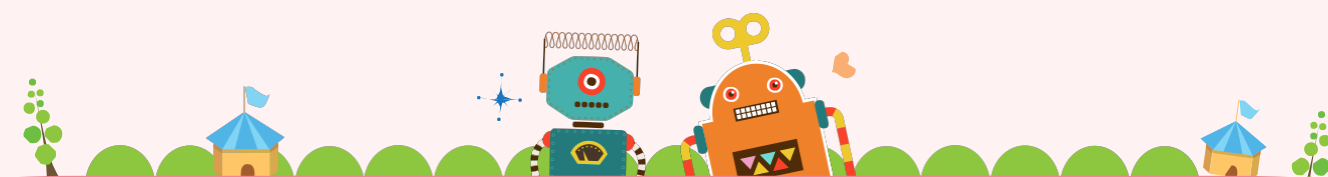

Запрограммируем движение робота  
стрекозы на программной плате.

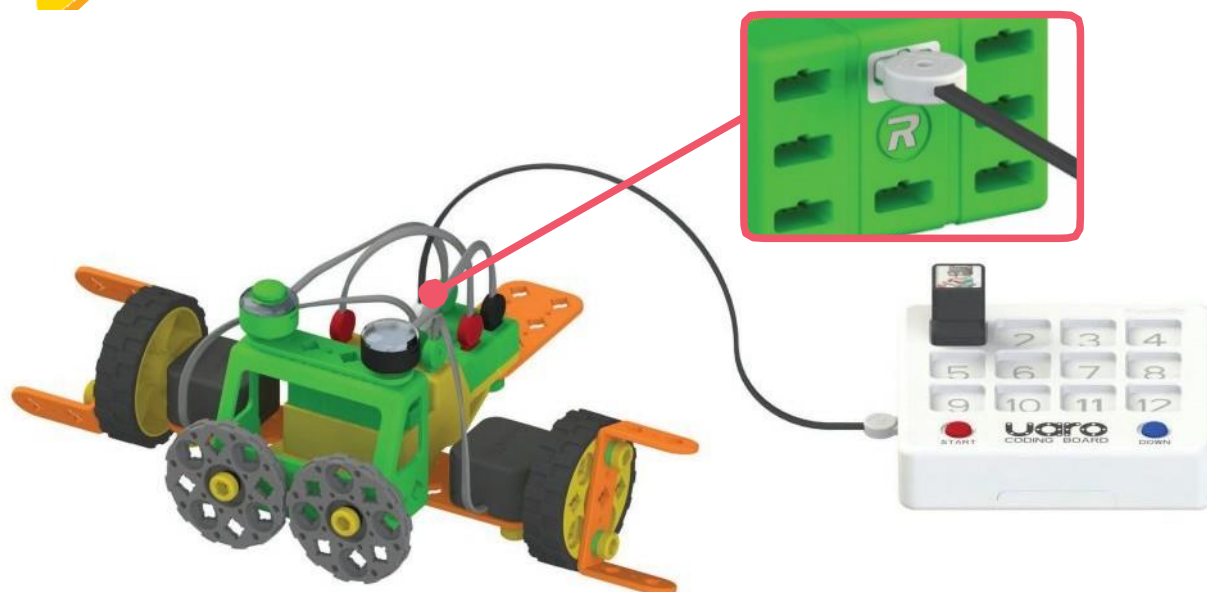

Управляйте стрекозой с помощью устройства  
дистанционного управления

6-й



Познакомимся с пугалом



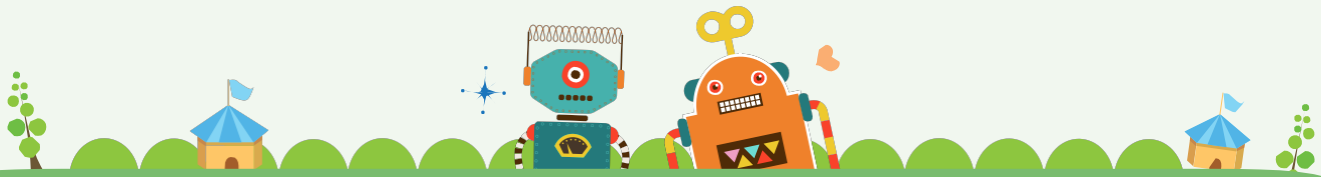

Детали



x1

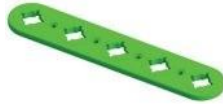

x2



x2



x2



x2



x2

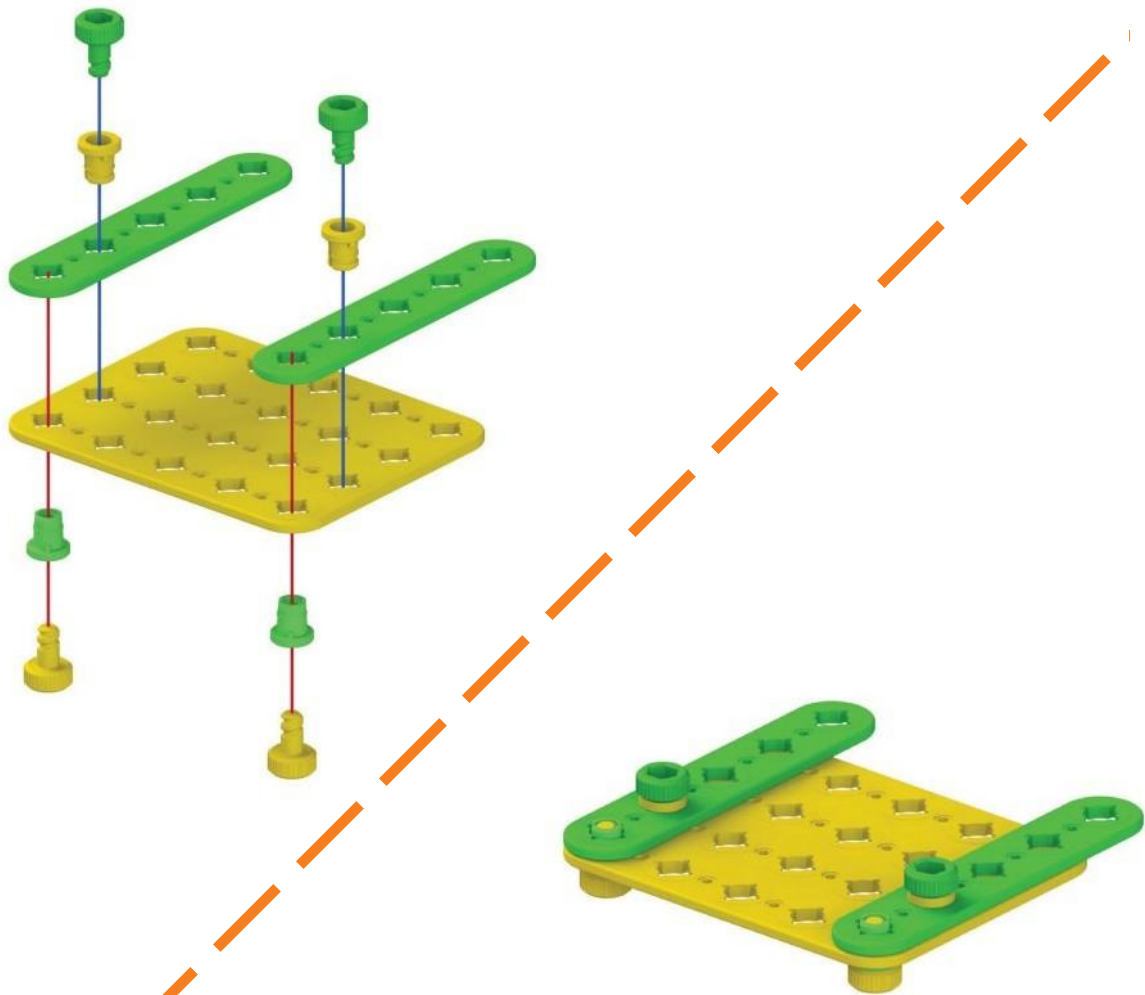



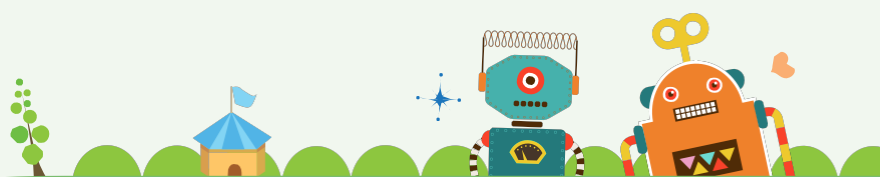

2

Детали



x1



x2



x2

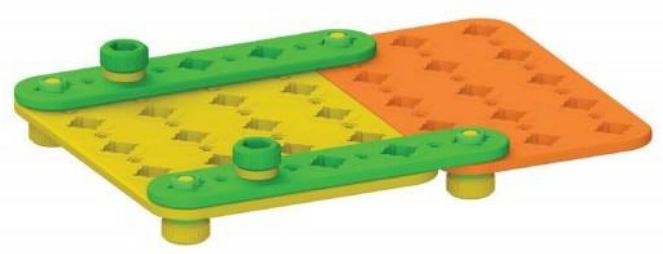
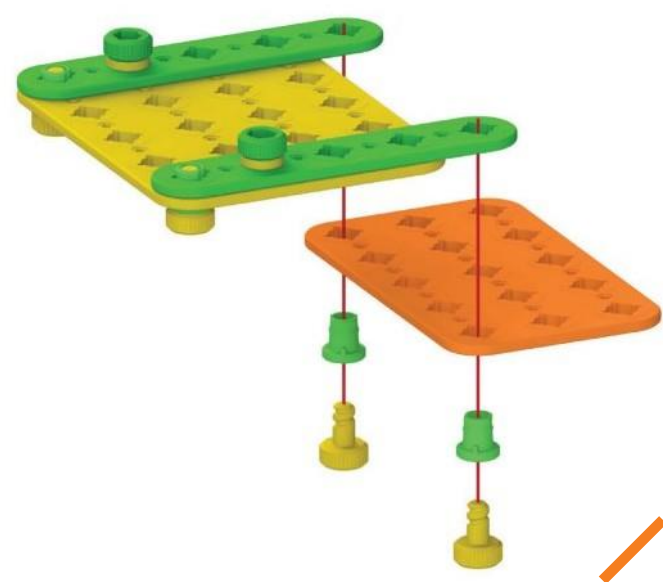

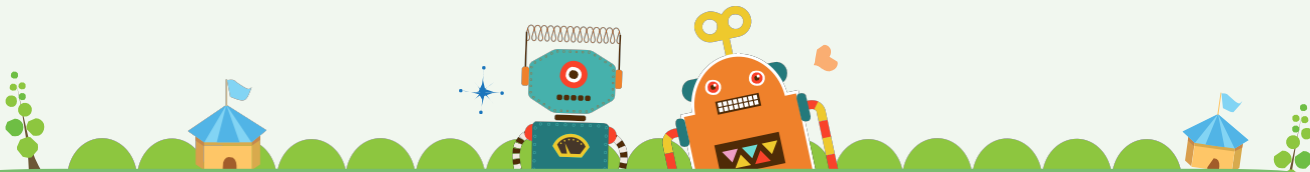

3

Детали



x1



x2



x2

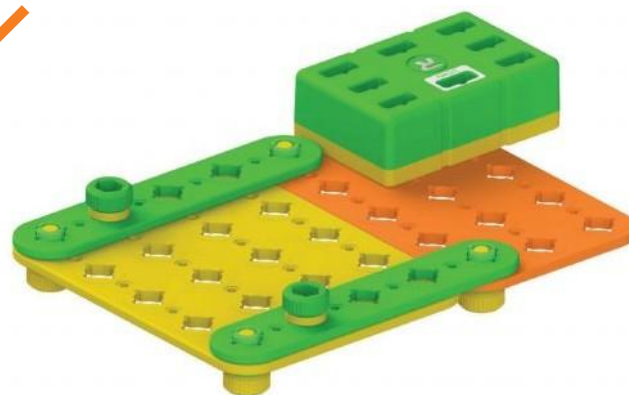
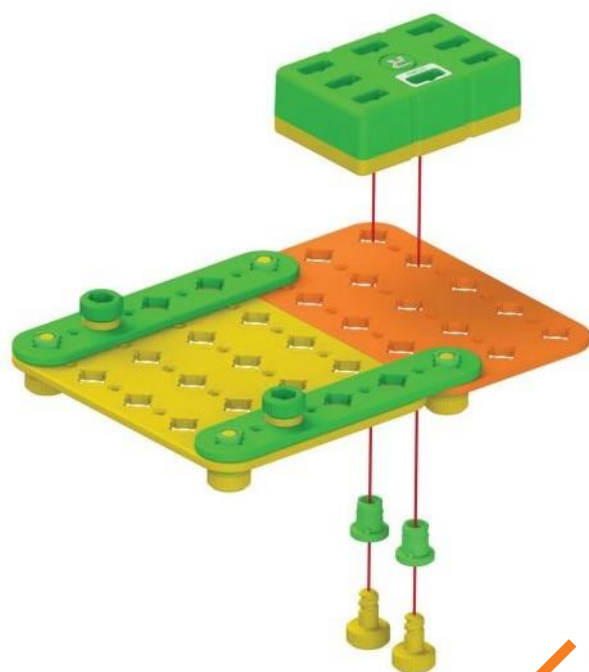

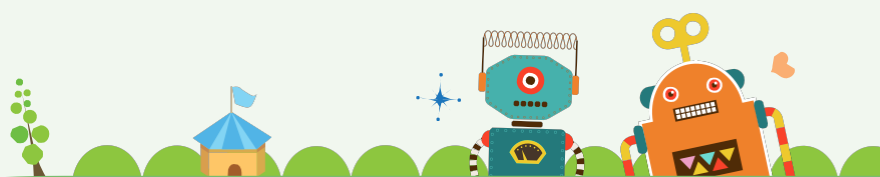

4 Детали



x1



x2



x2

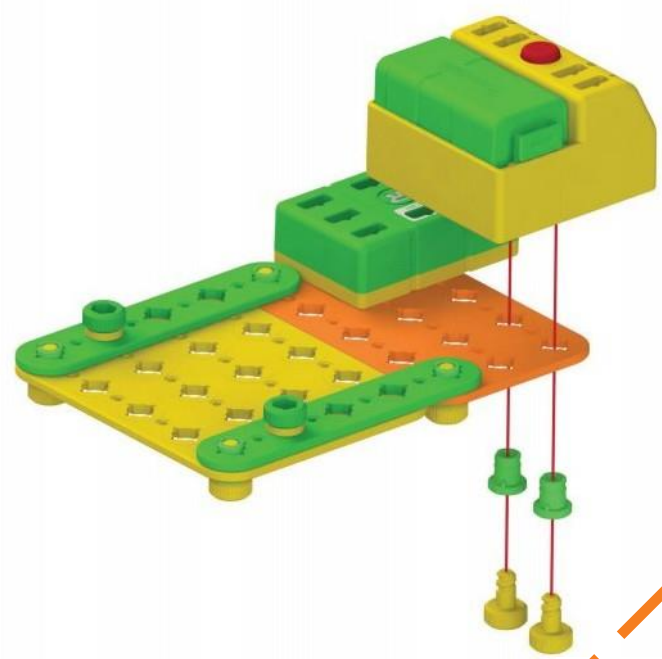

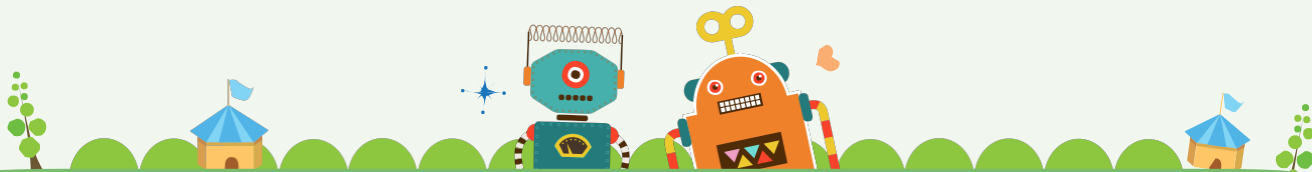

5

Детали



x1



x1



x2



x2

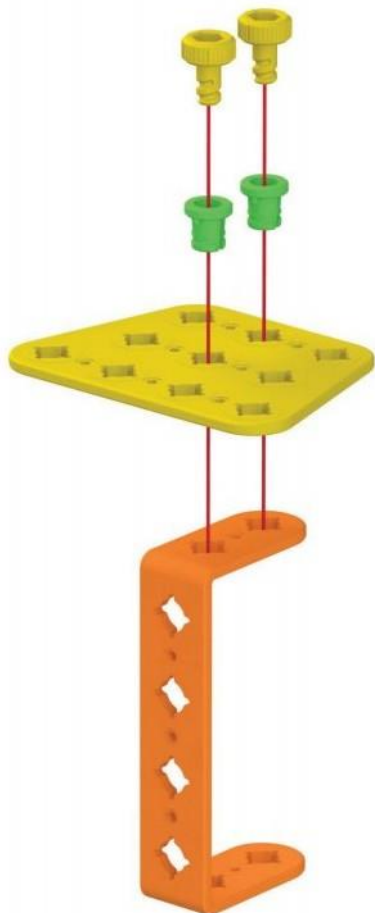

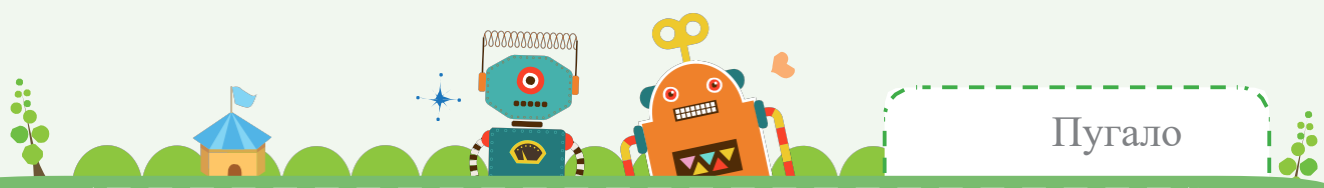

6 Детали

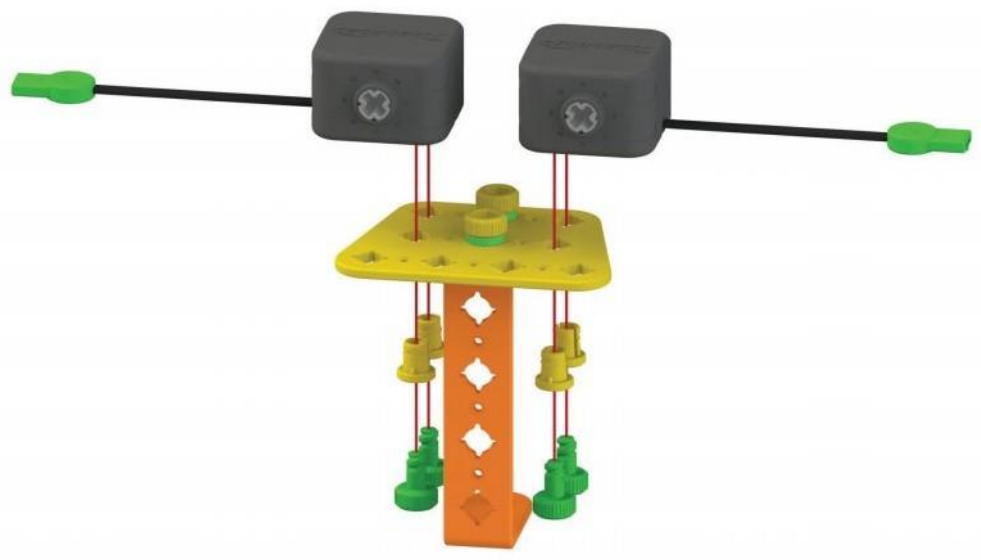

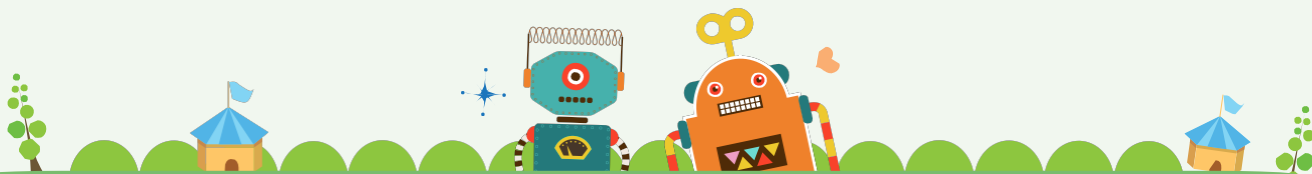

Детали



x2



x2



x2



x2

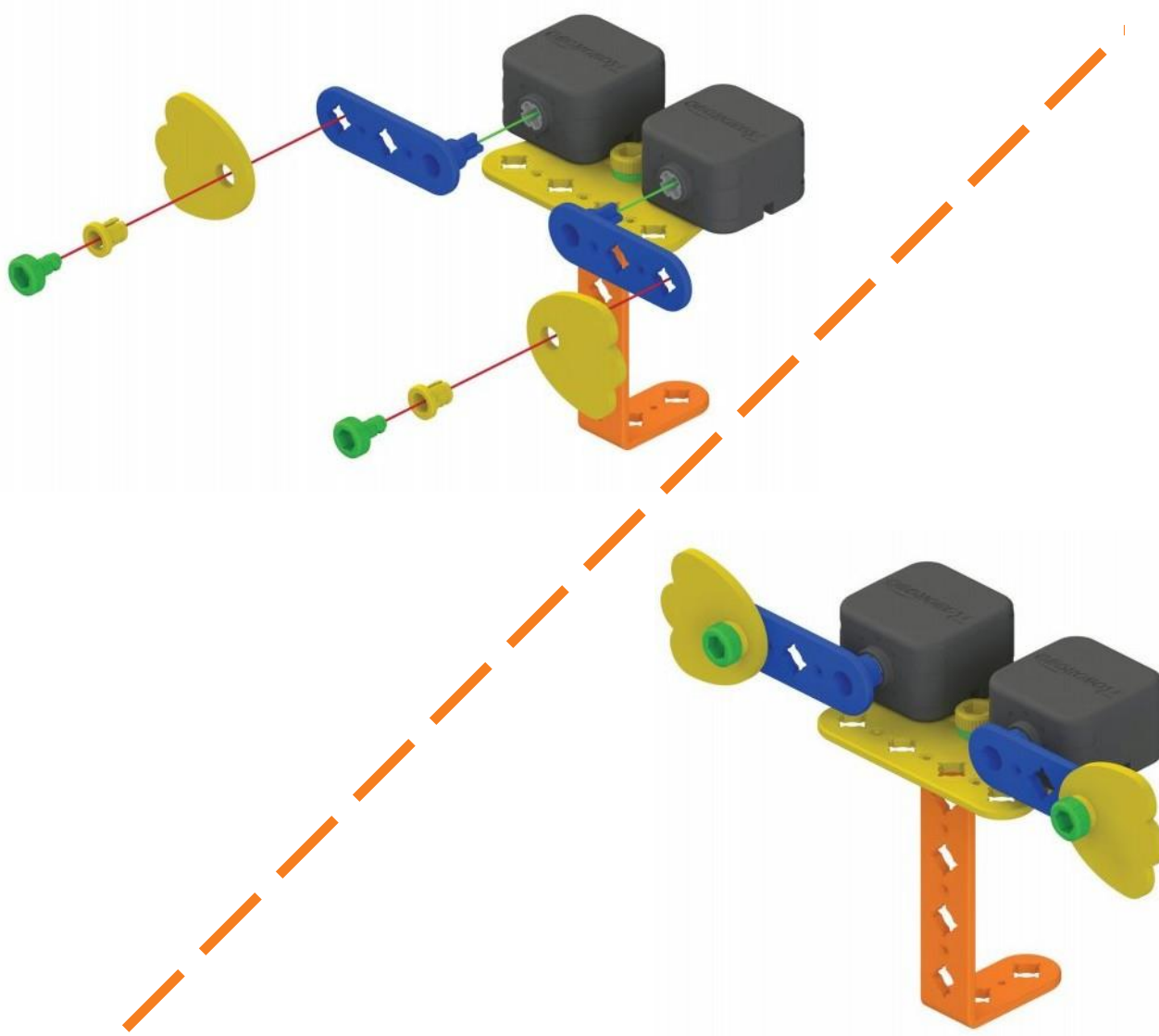



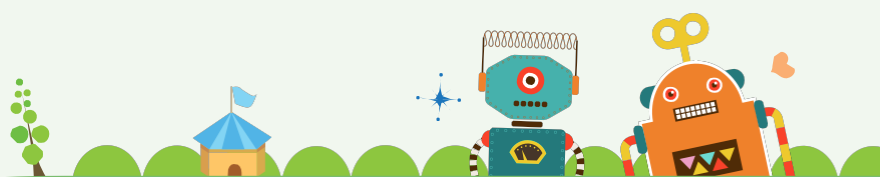

Детали



x1



x2



x2



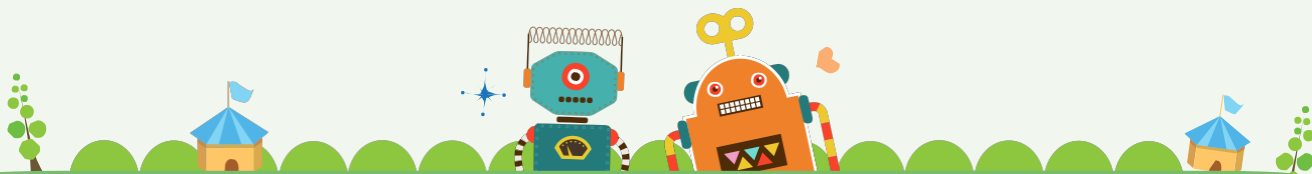

9

Детали



x1 x2



x2 x2

x2

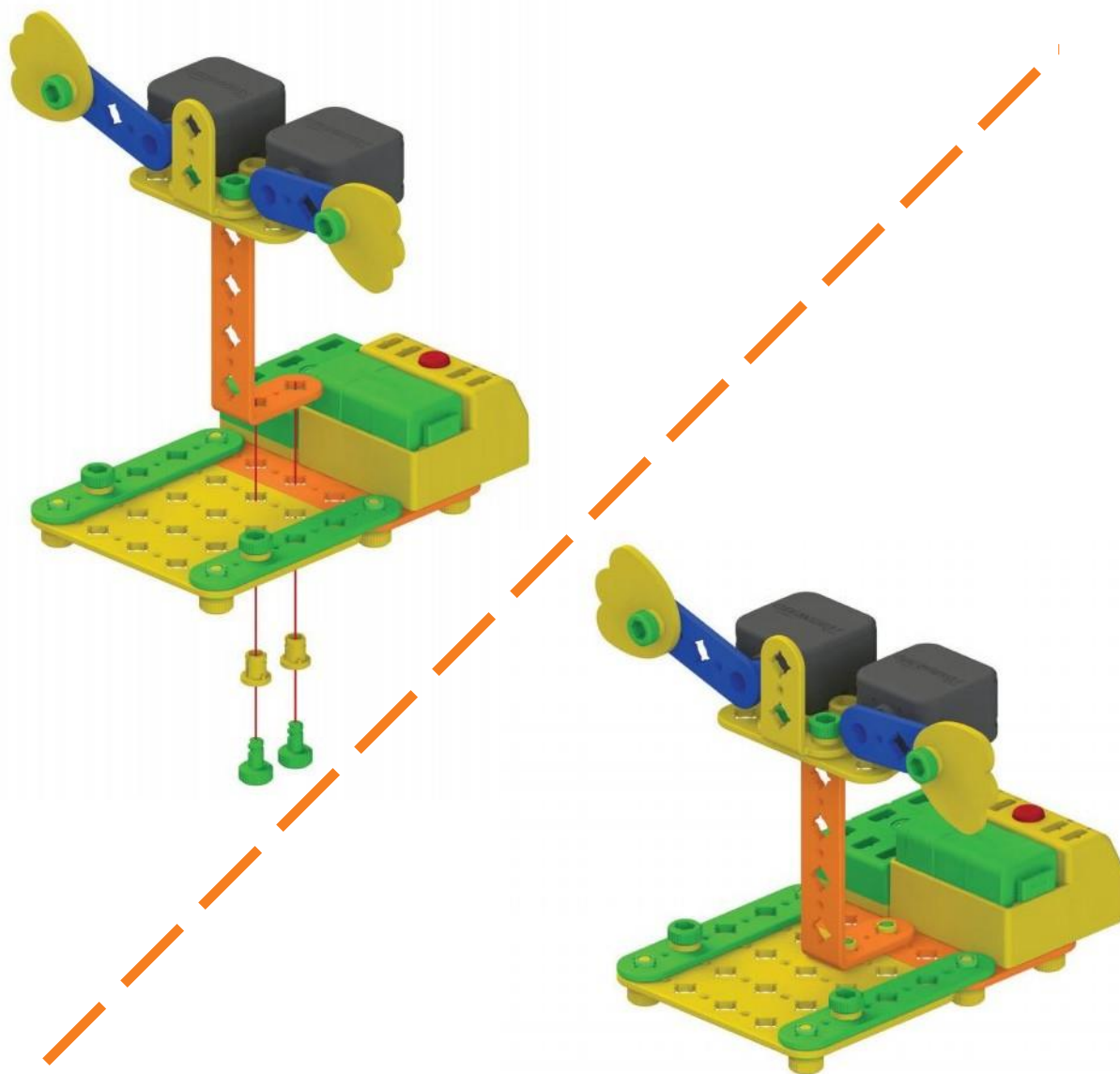

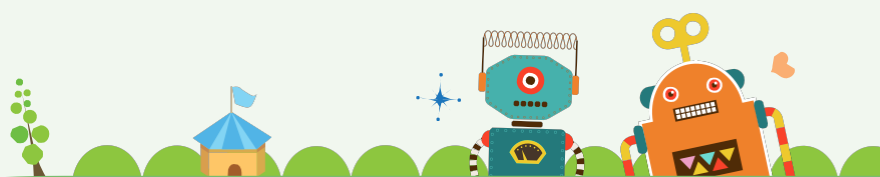

Детали



x1



x1

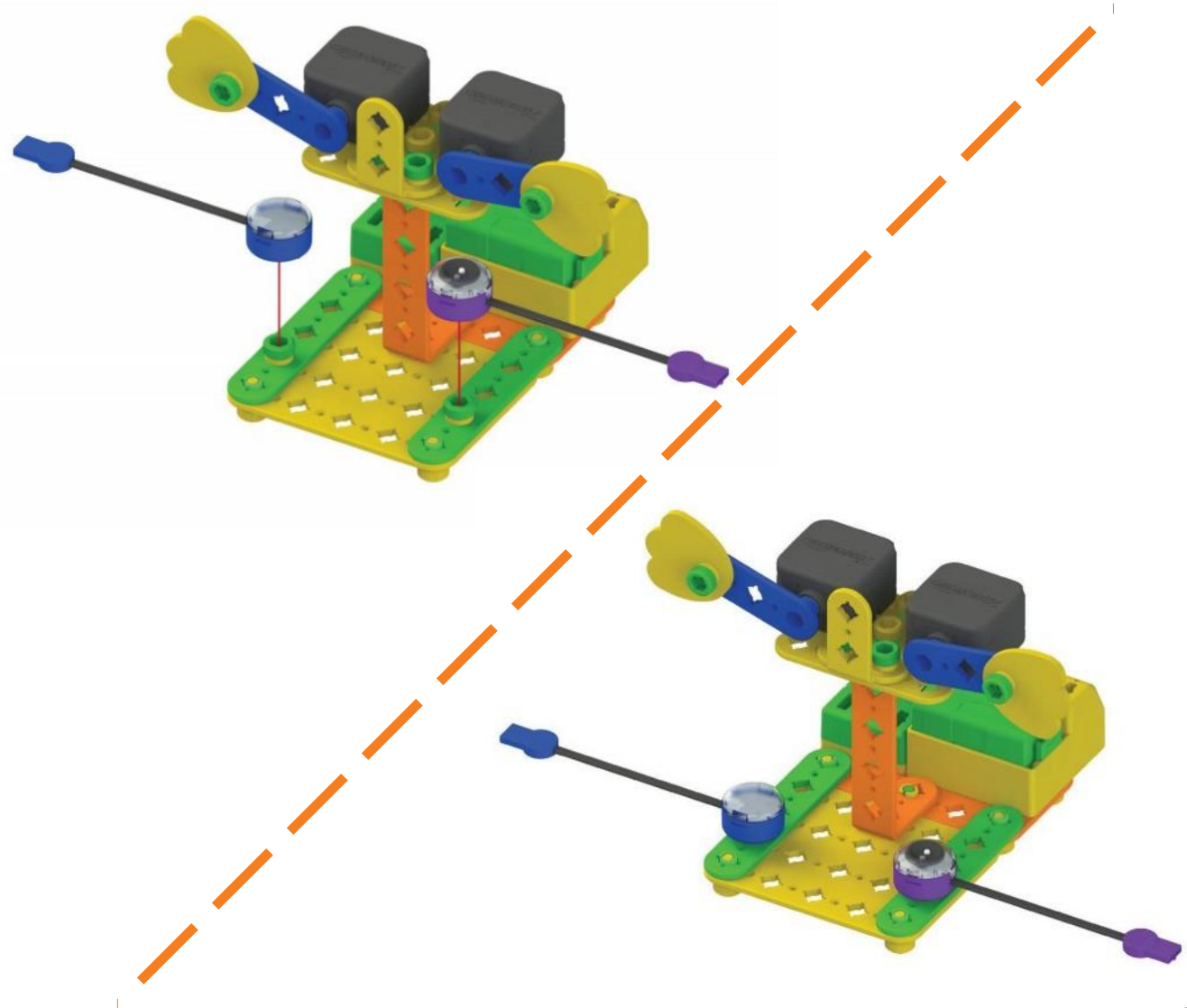

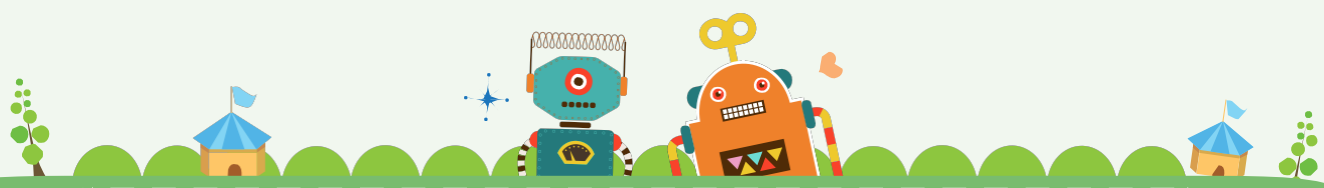

Левый электродвигатель  
Подключите к А

Левый электродвигатель  
Подключите к В

Двухсторонний кабель  
Подключите к порту D и ЦП

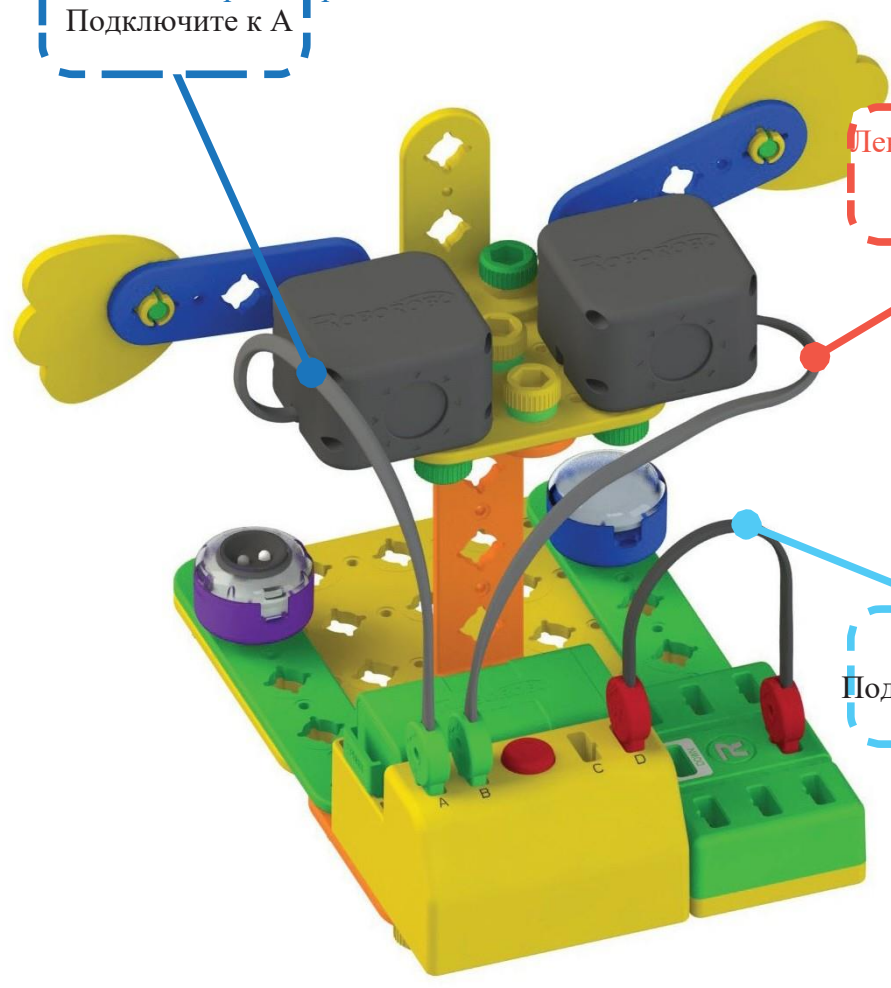

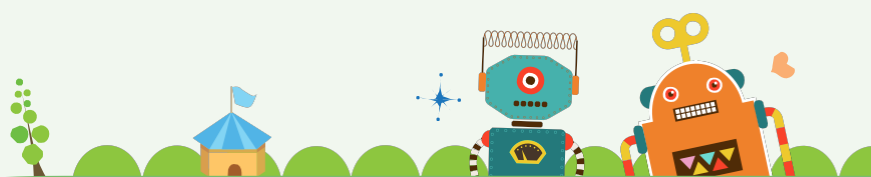

Пугало

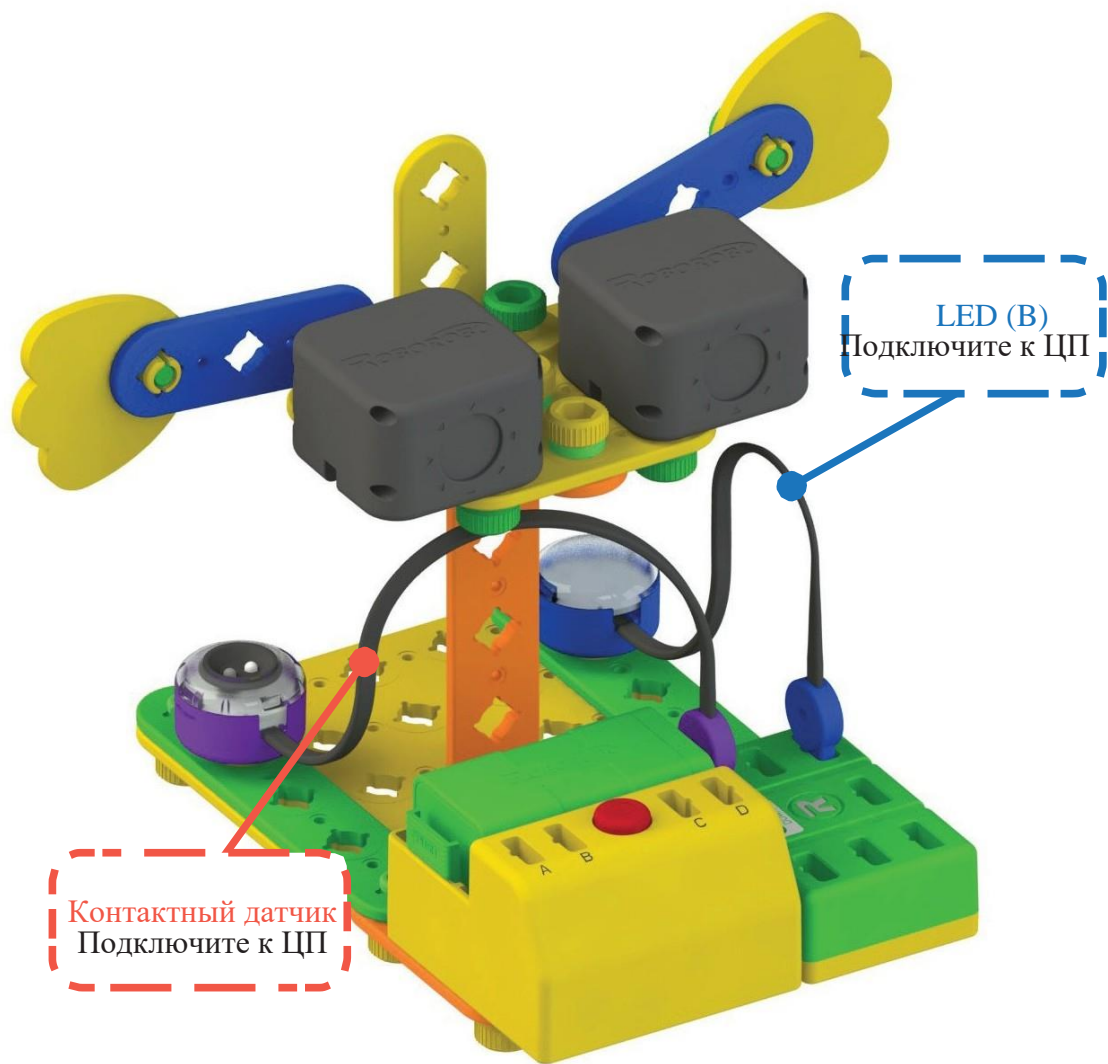

Контактный датчик  
Подключите к ЦП

LED (B)  
Подключите к ЦП

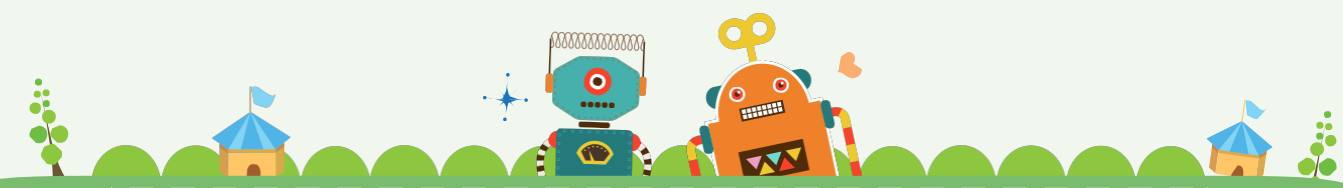

Украсьте пугало. (стр. 216)





Создадим  
Программу

Запрограммируем движение робота пугала на программной плате.

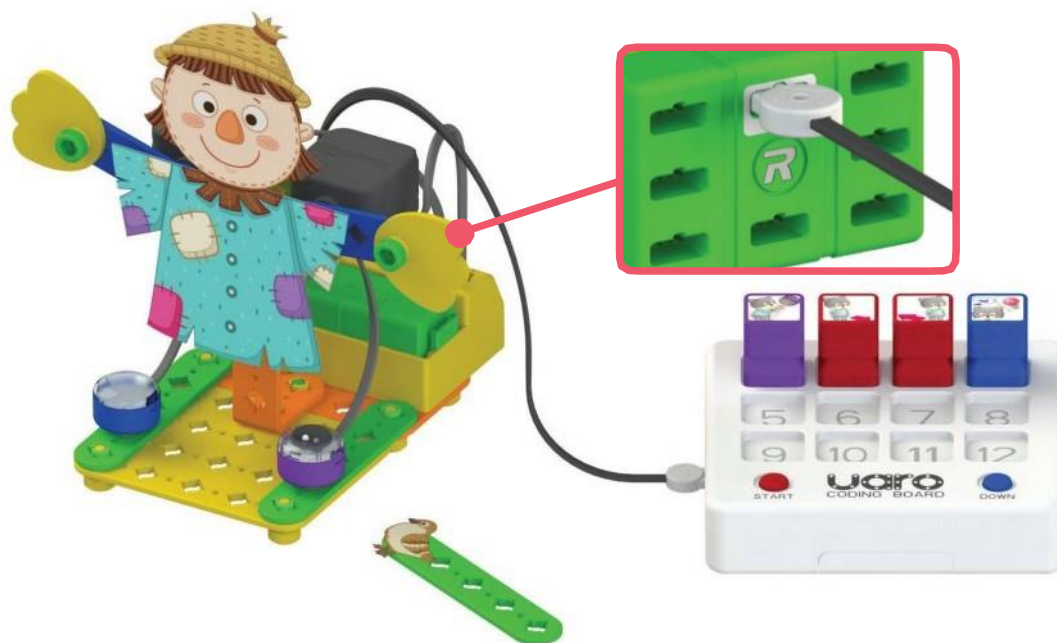

Если птица дотронется до датчика, пугало выполнит взмах руками, при этом загорится LED.

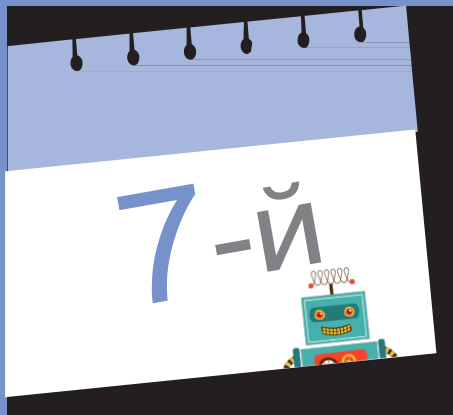

Сделаем трактор!



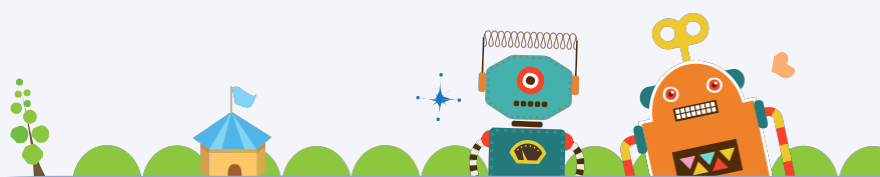

Детали



x1



x2



x2



x2

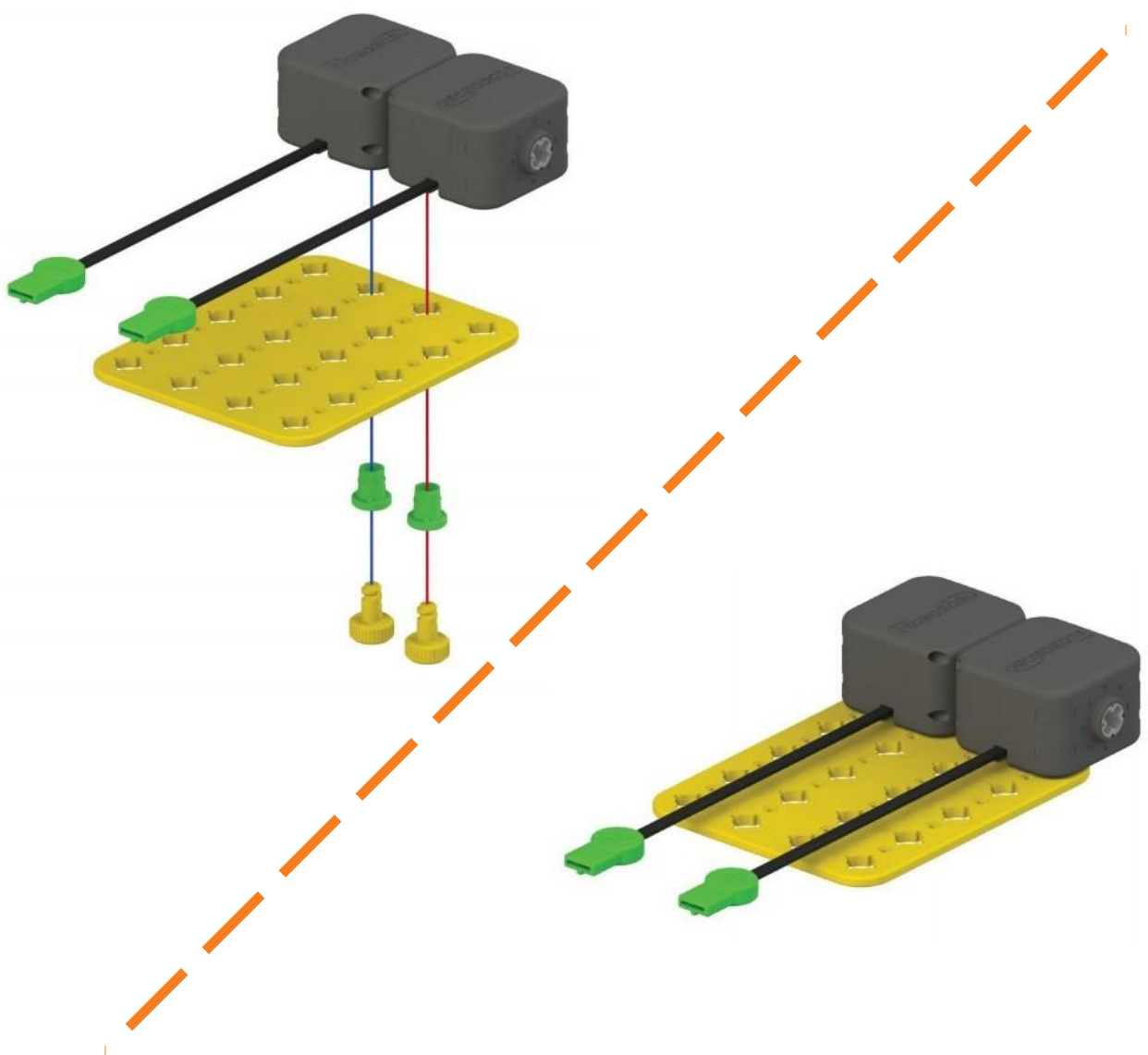

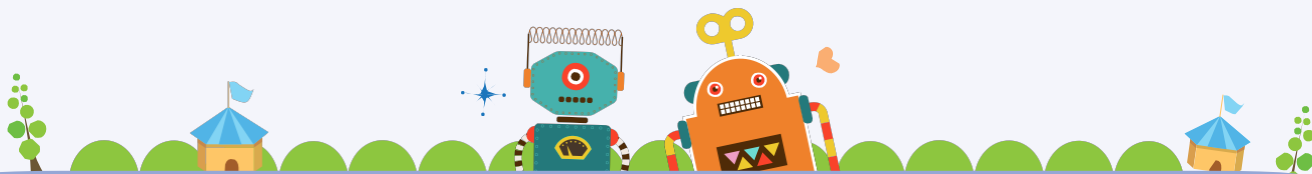

2

Детали



x1



x2



x2

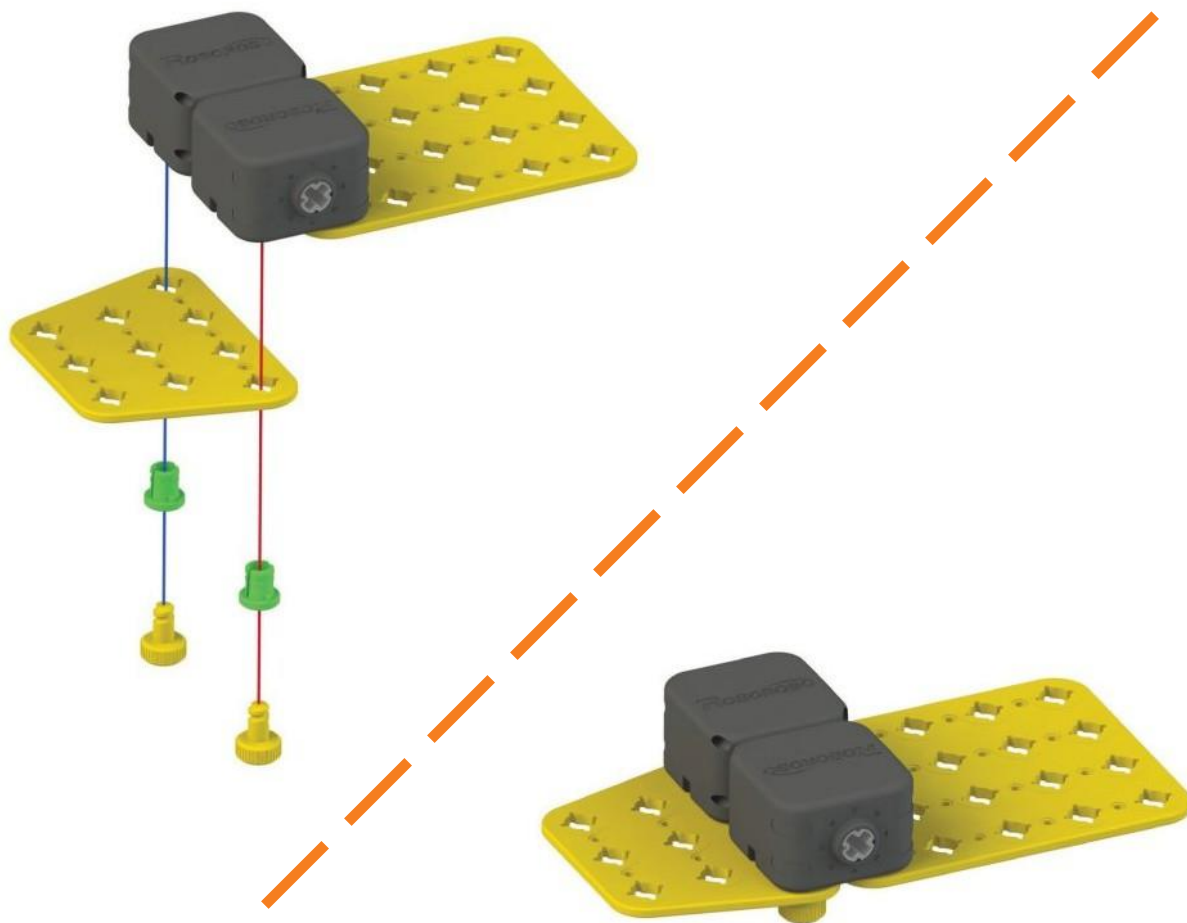

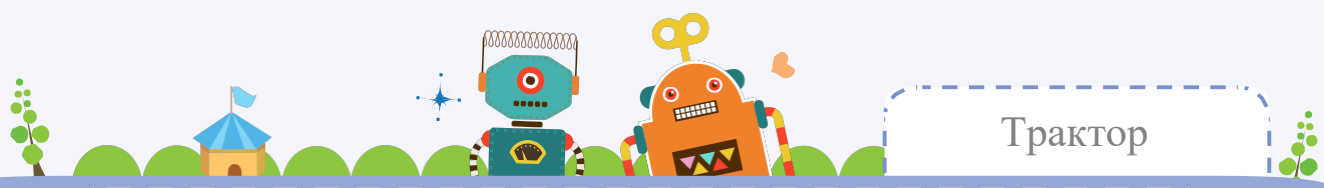

3

Детали



x1



x2



x2



x2

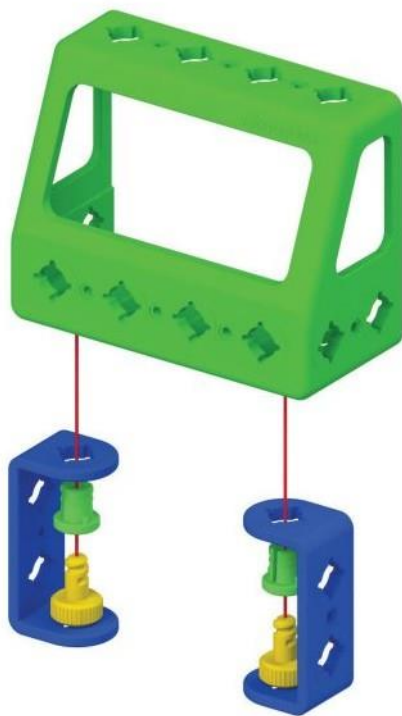

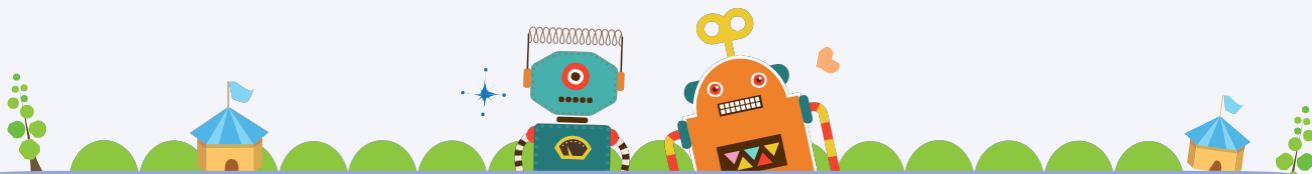

4

Детали



x1



x1



x2



x2

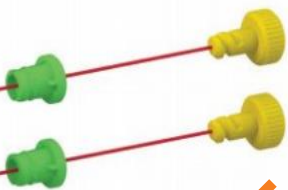



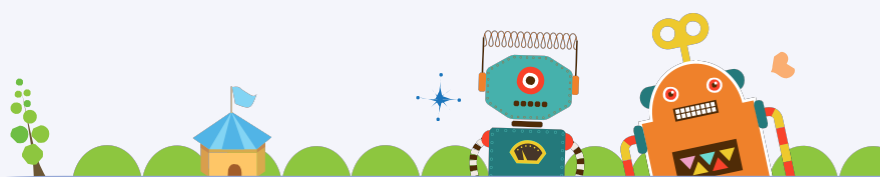

5

Детали



x2



x2



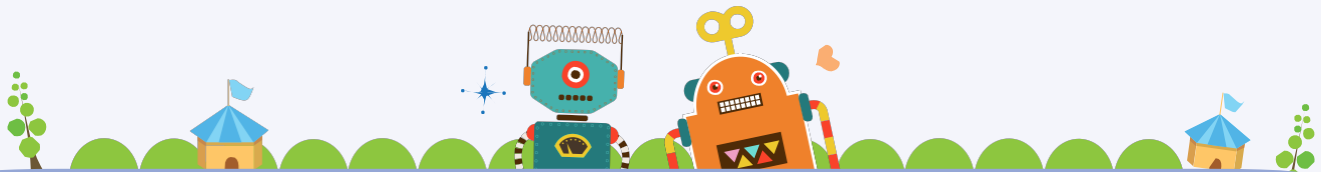

6

Детали



x1



x2



x2



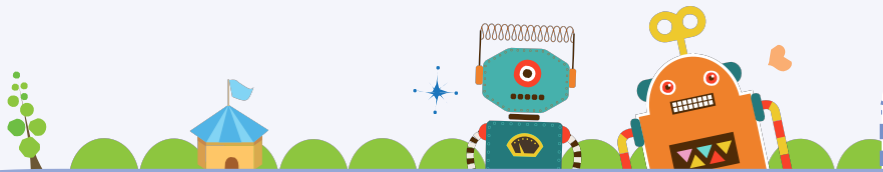

Детали



x2



x2



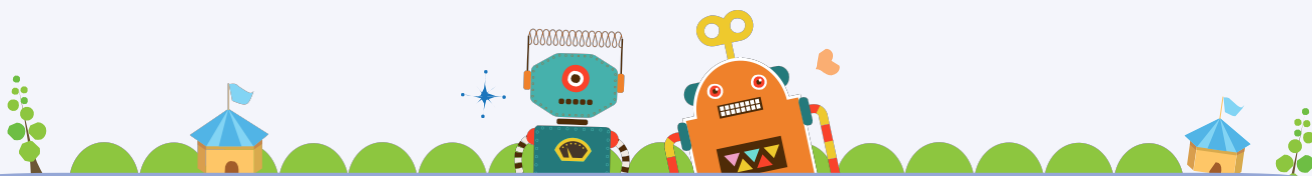

8

Детали



x1



x2



x2

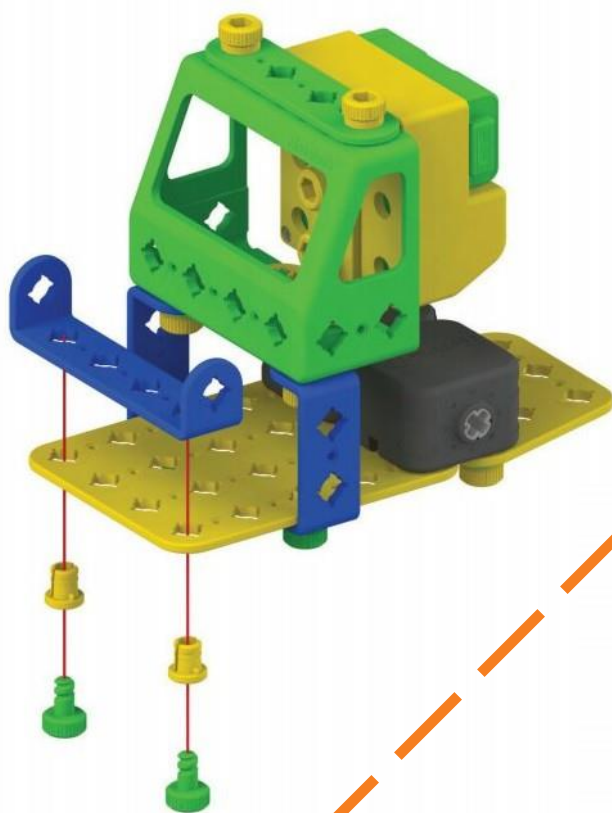

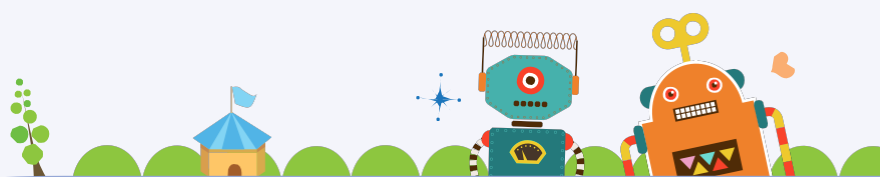

9

Детали



x2



x1



x2



x2

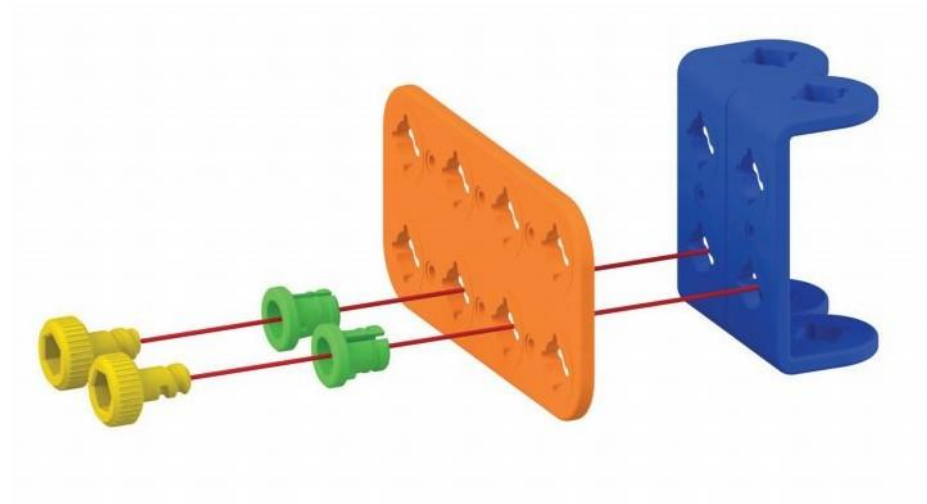

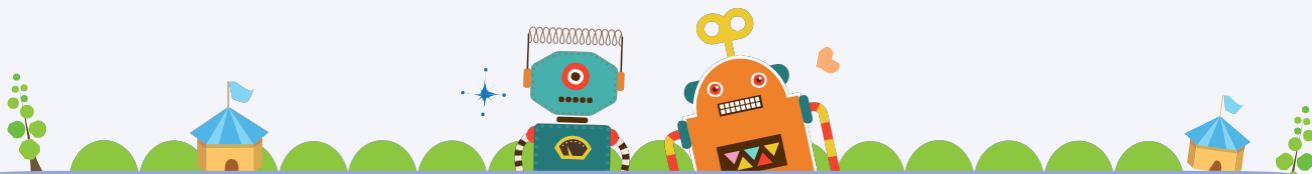

10

Детали



x1



x2



x2





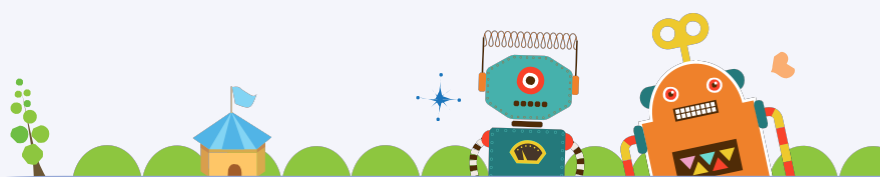

Детали



x2



x2



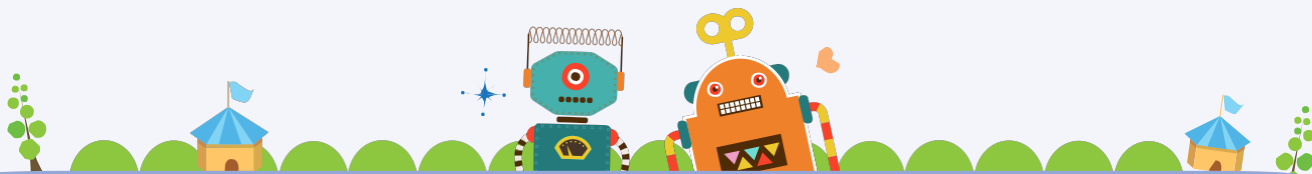

12

Детали



x2



x2



x2



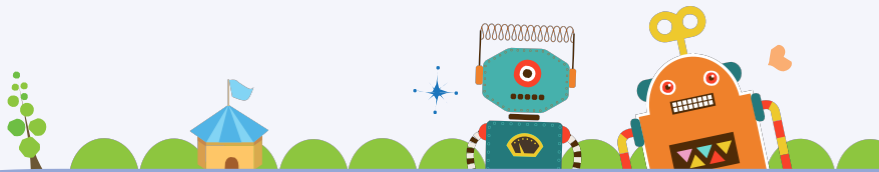

13

Детали



x1



x2



x2

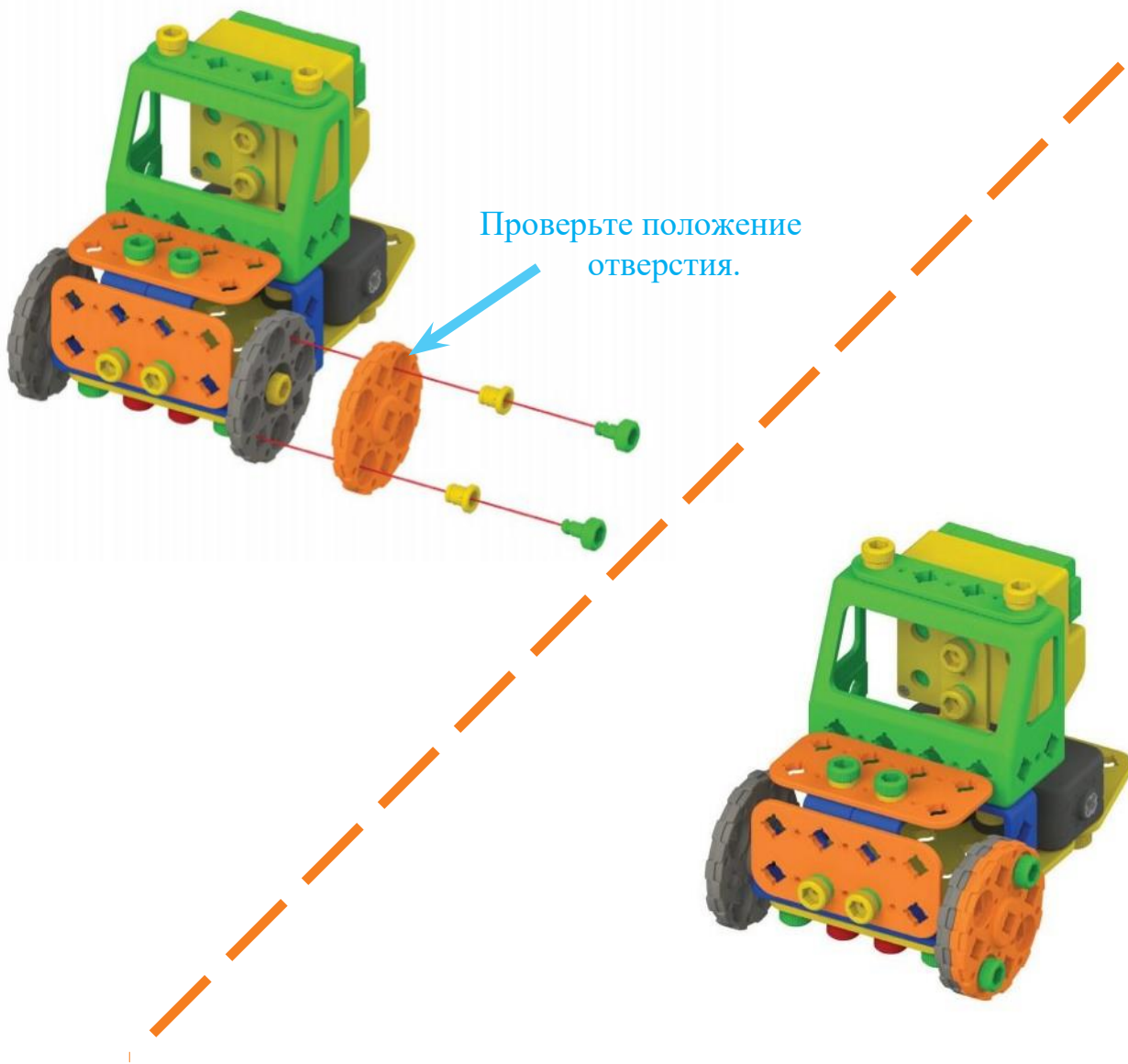

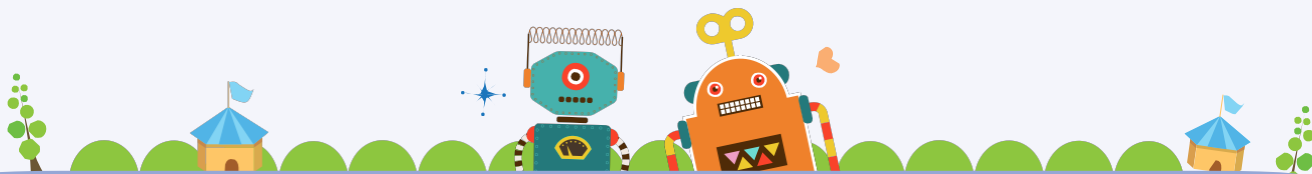

14

Детали



x1



x2



x2

Проверьте положение  
отверстия.

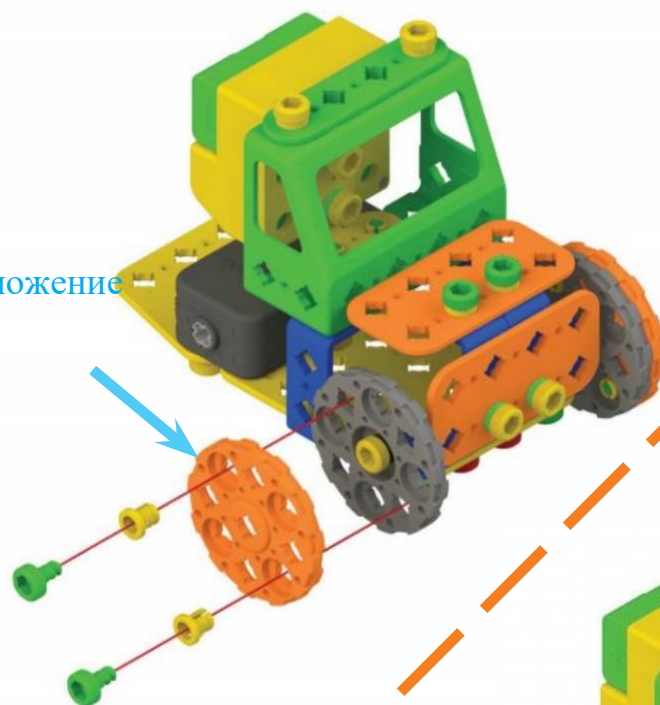

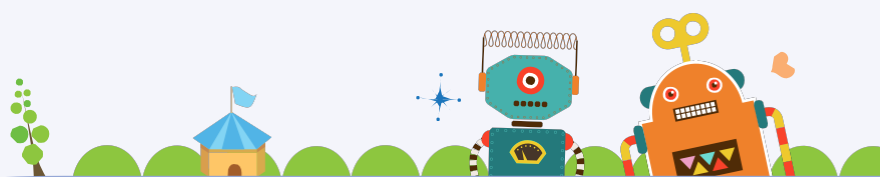

15

Детали



x2

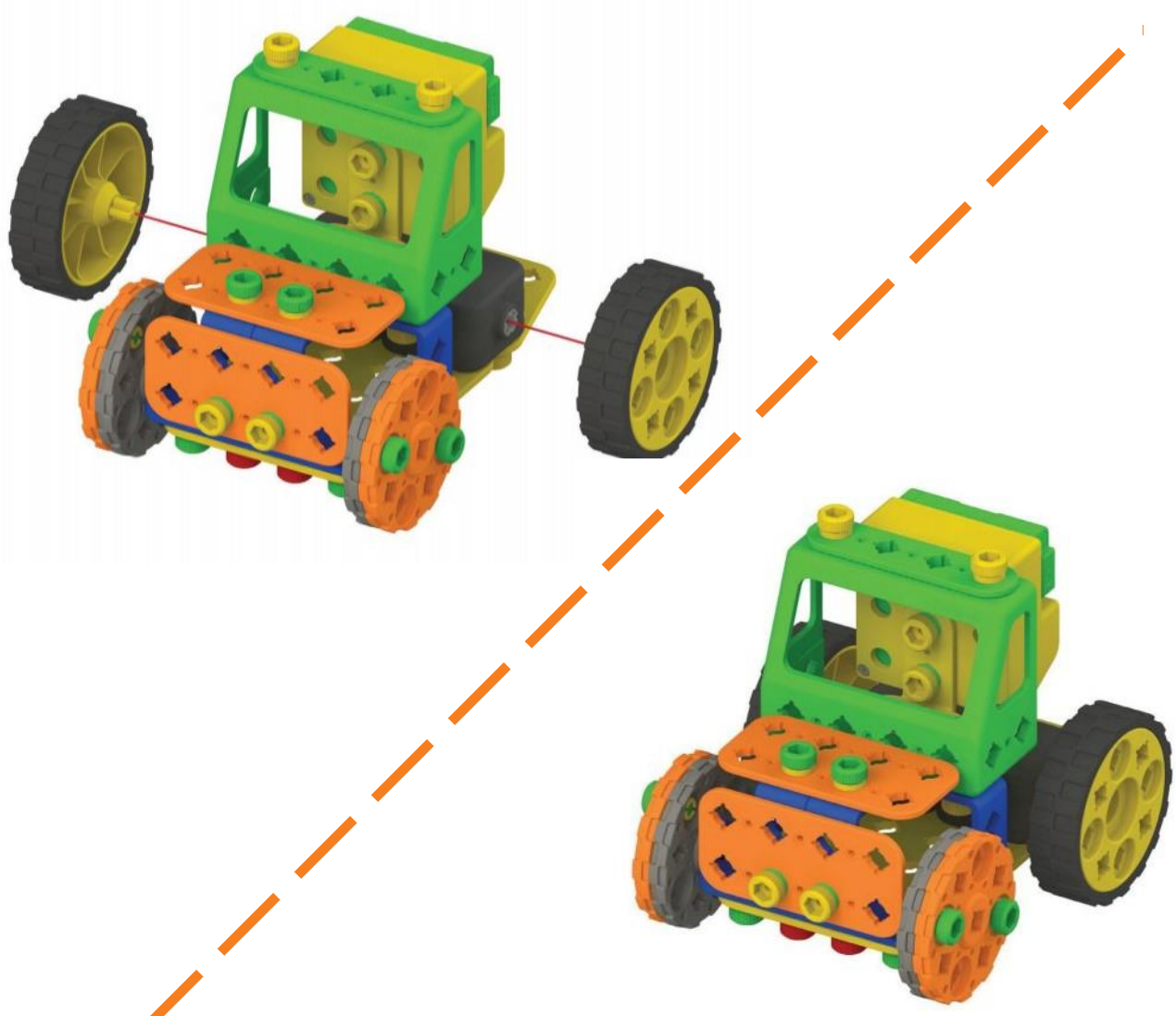



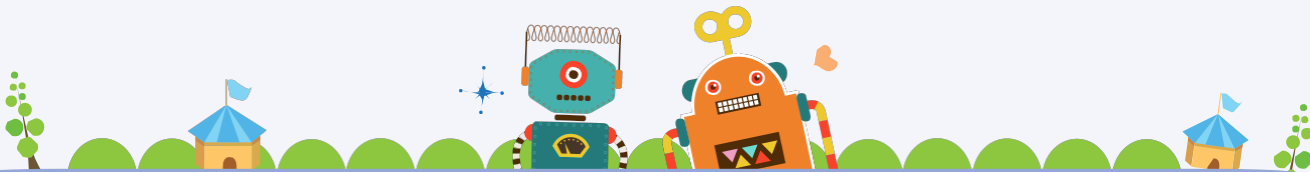

16

Детали



x1



x2



x2

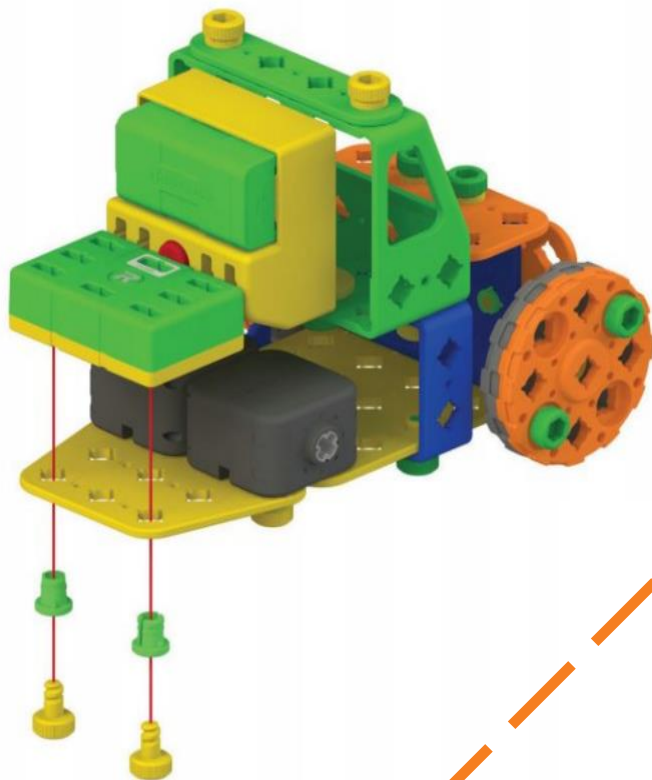



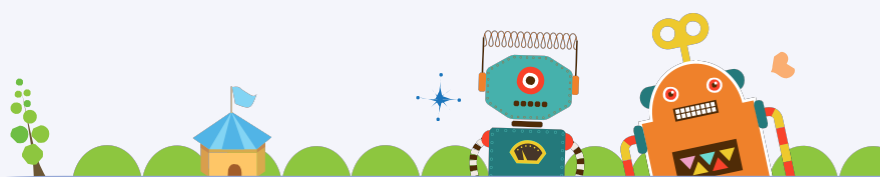

Детали



x1



x1

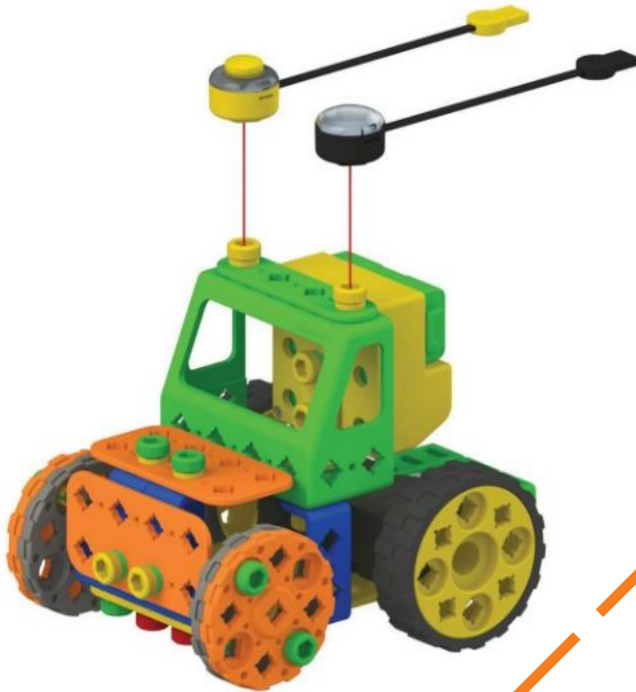

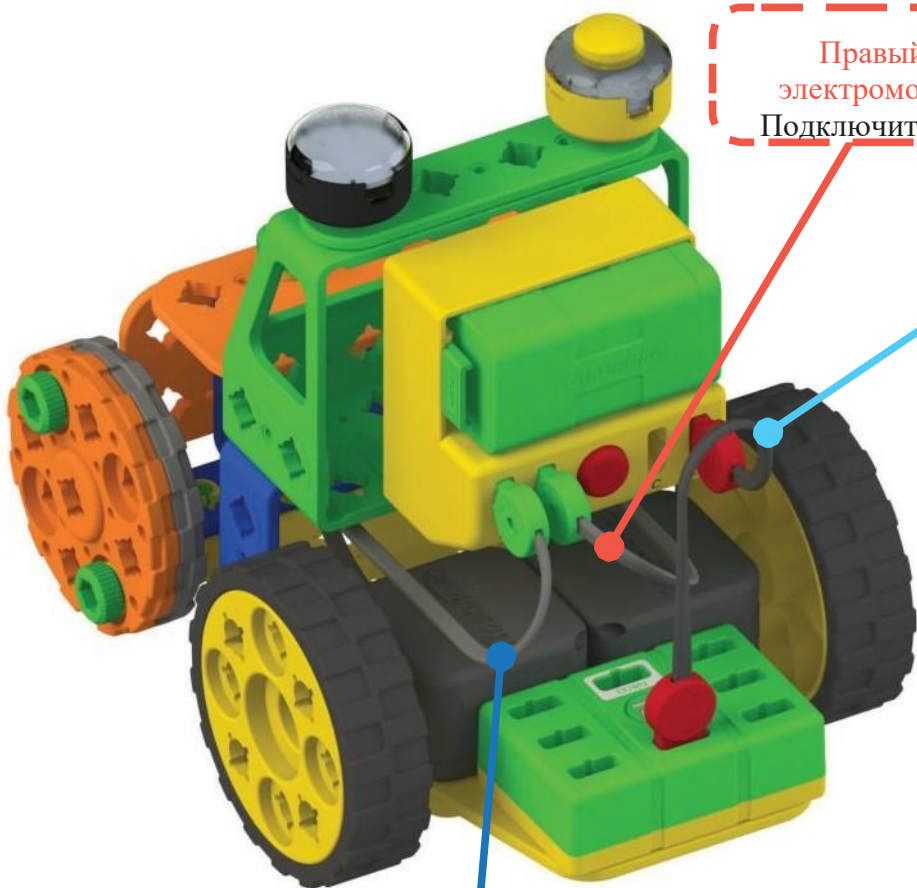
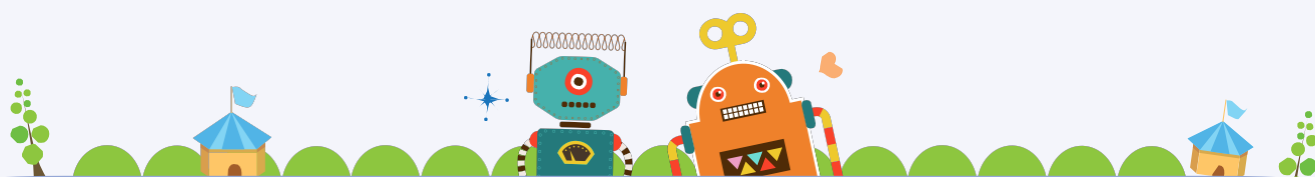

Правый  
электромотор  
Подключите к В

Двухсторонний кабель  
Подключите к порту D и ЦП

Левый  
электромотор  
Подключите к А

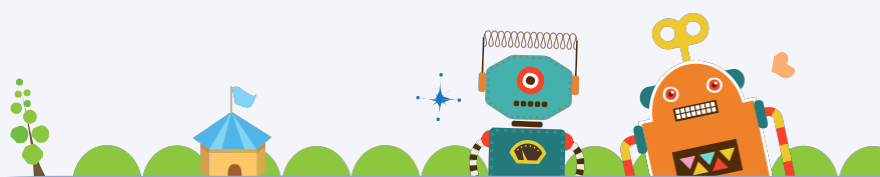

# Трактор

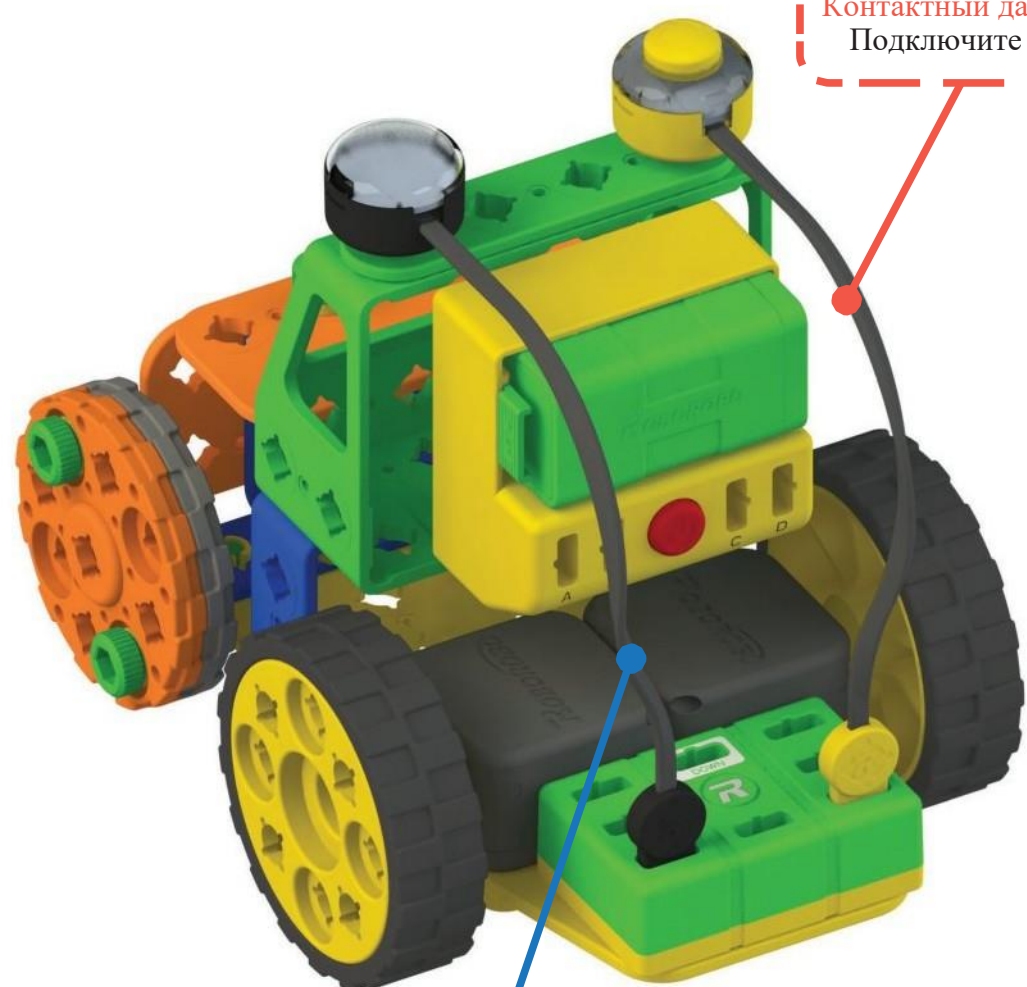

Контактный датчик (Y)  
Подключите к ЦП

Плата дистанционного  
приемника  
Подключите к ЦП

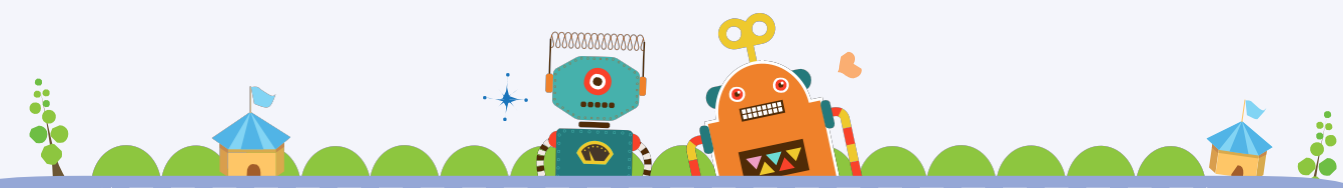

Запрограммируем движение робота трактора на программной плате.

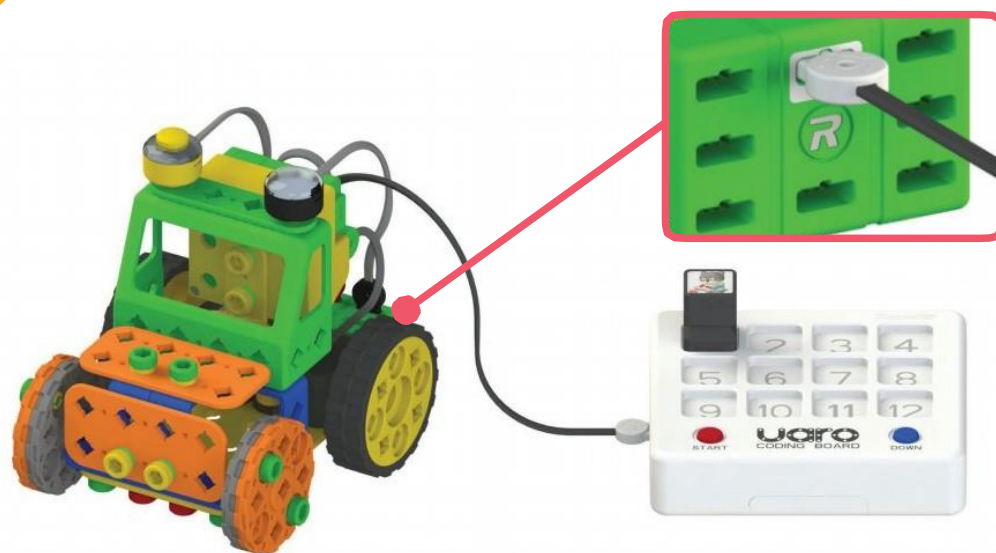

Управляйте трактором с помощью устройства дистанционного управления

8-й

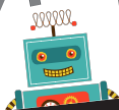

Познакомимся с роботом-помощником!

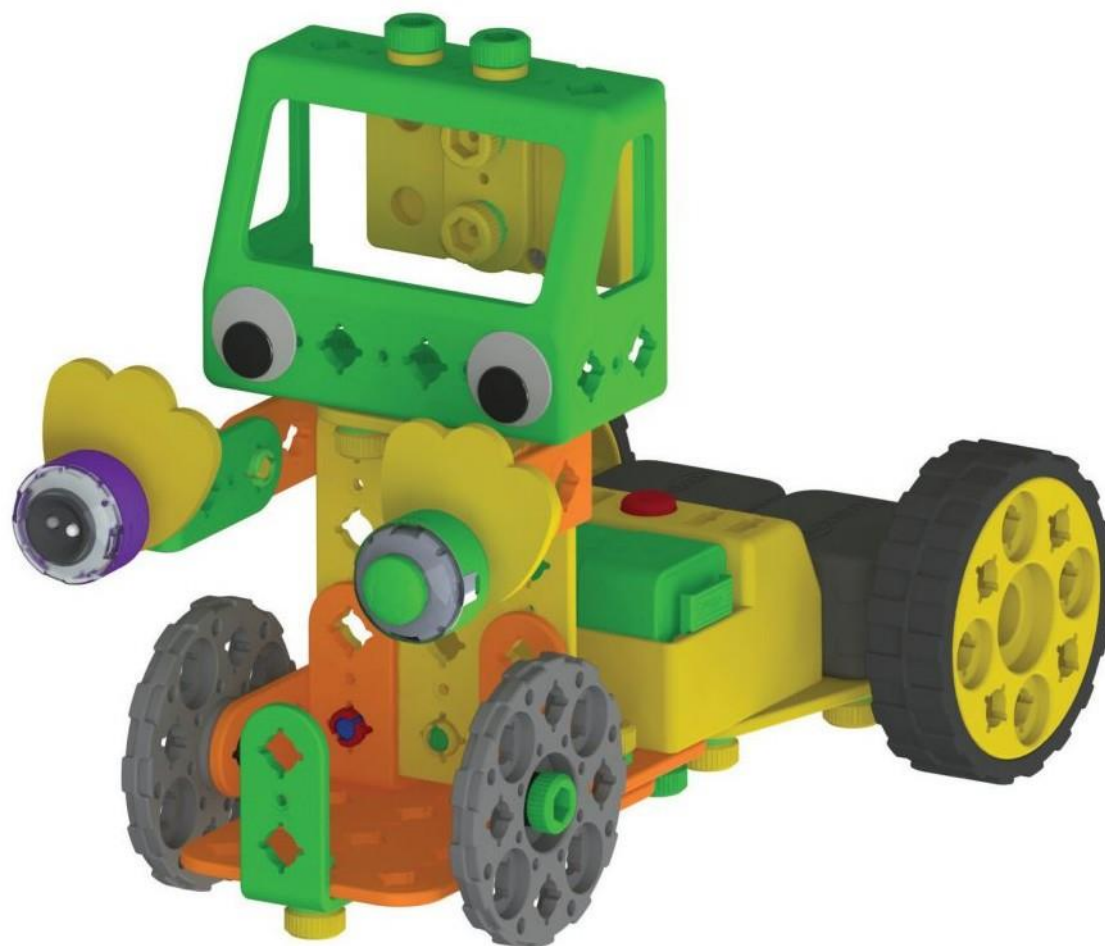

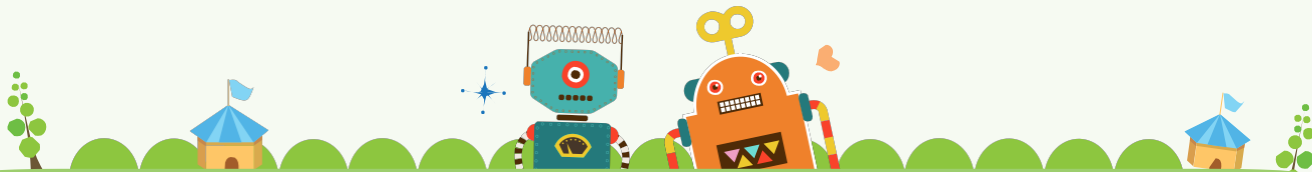

Детали



x1



x1



x1



x1

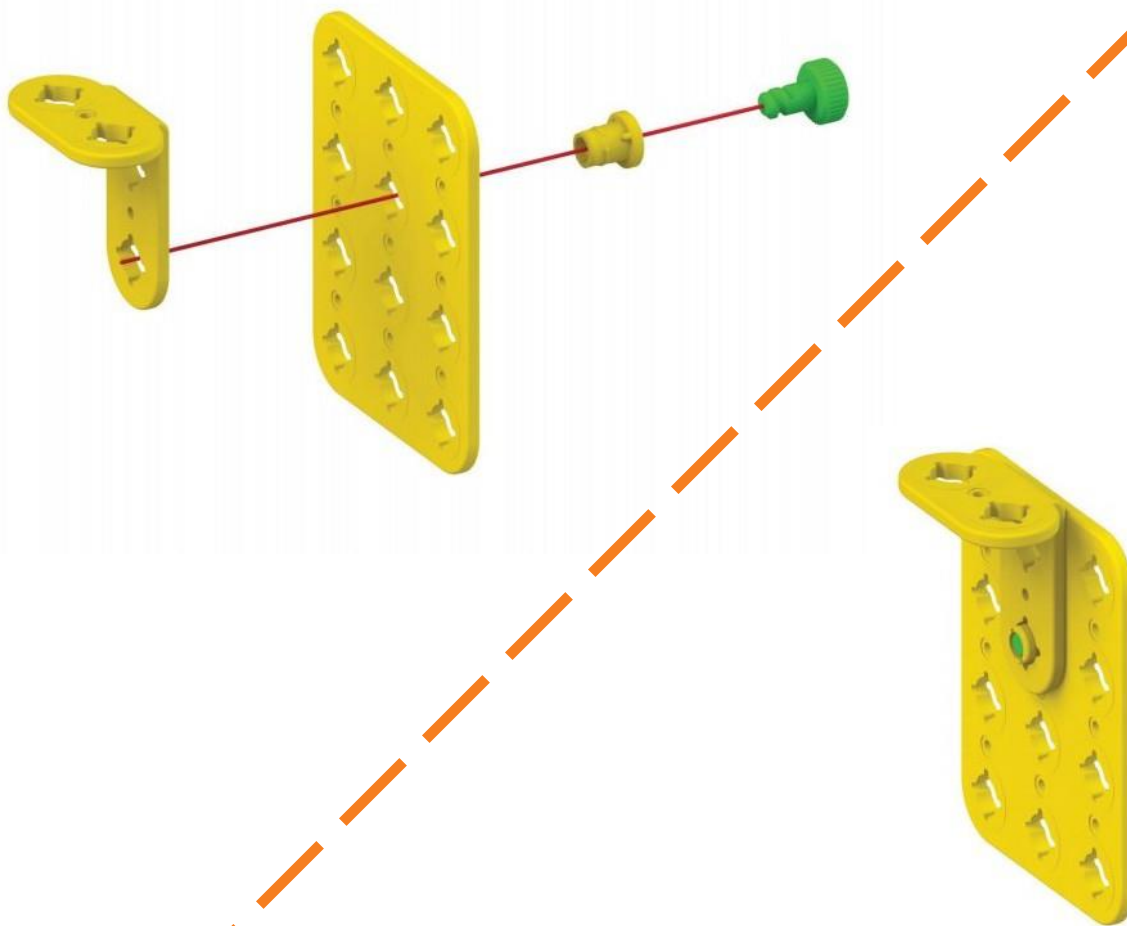



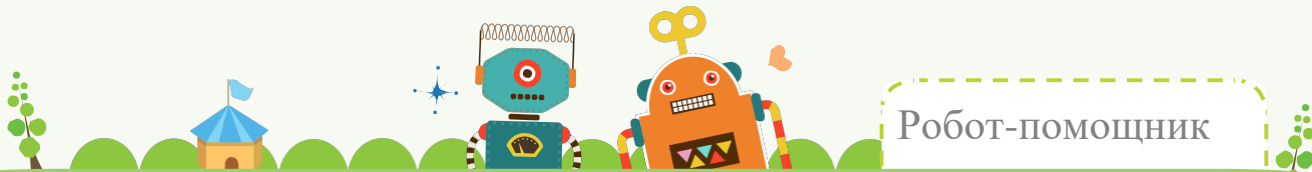

2

Детали



x1



x2



x2



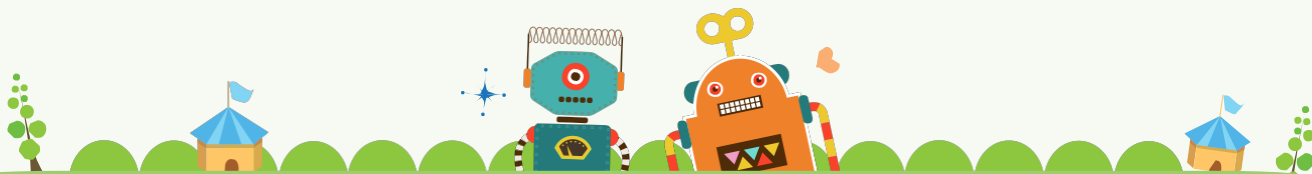

3

Детали



x2



x1



x1



x1



x1

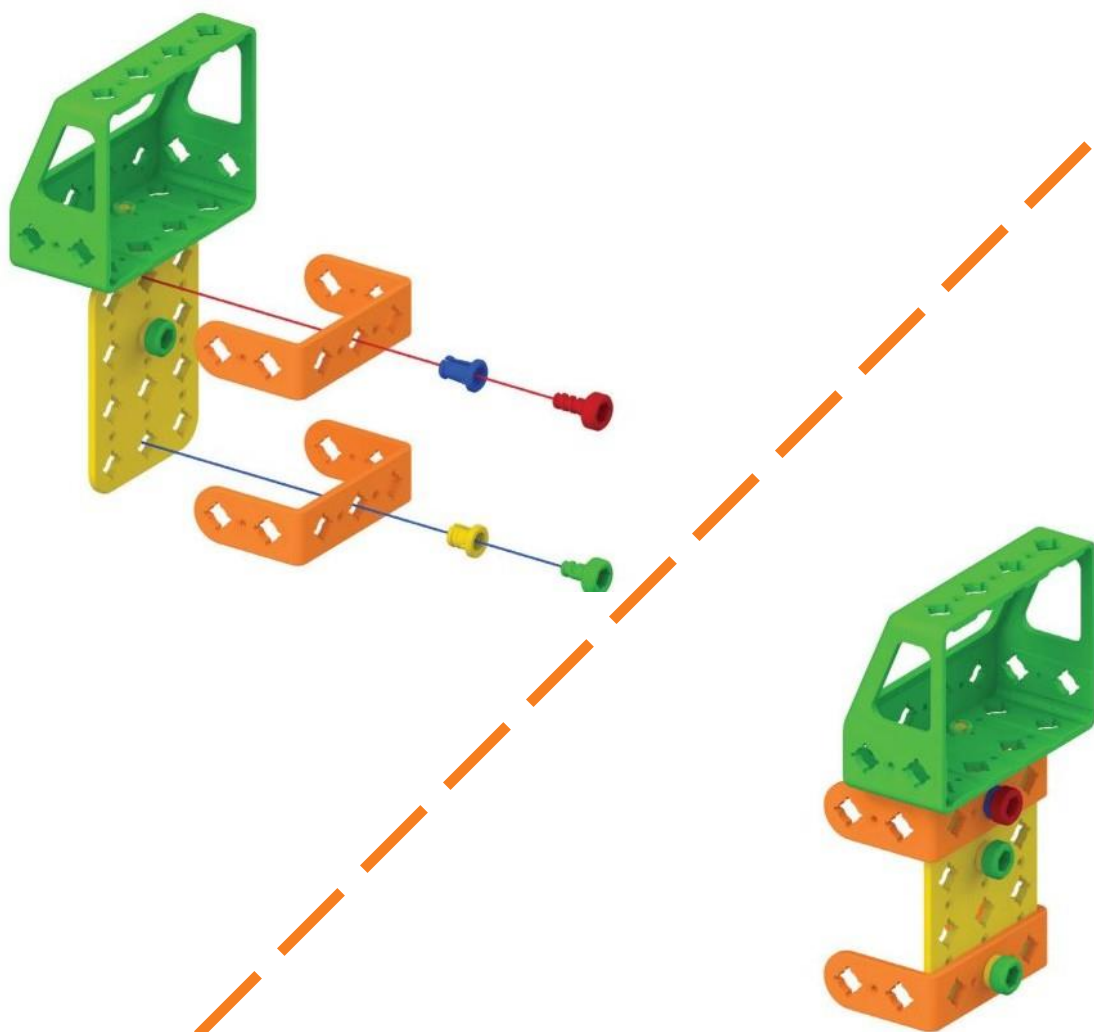

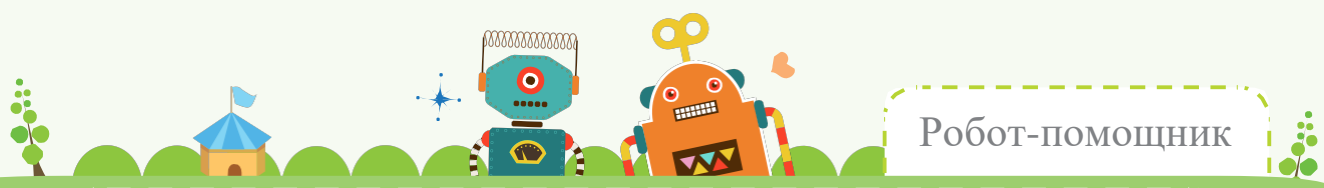

4 Детали



x2



x2



x2

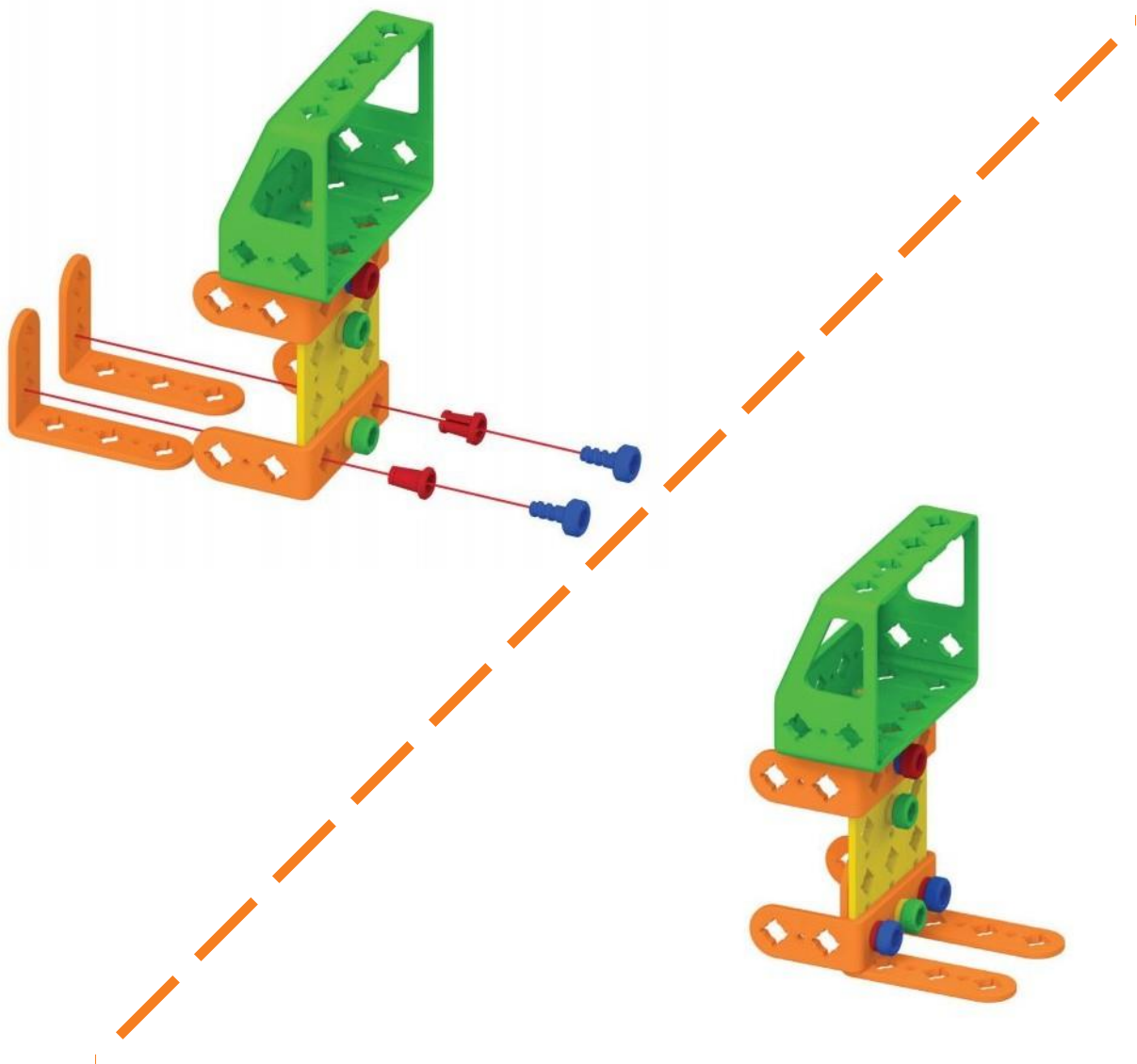

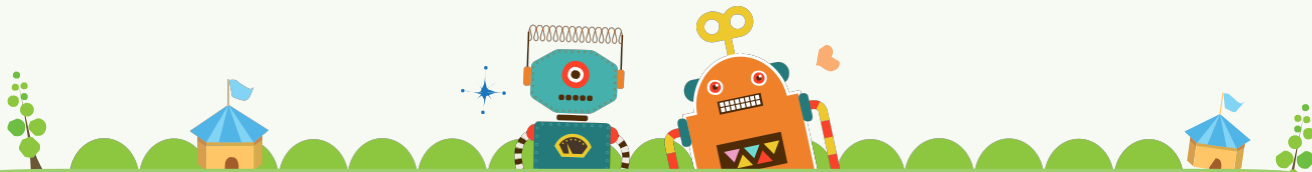

5

Детали



x1



x2



x2



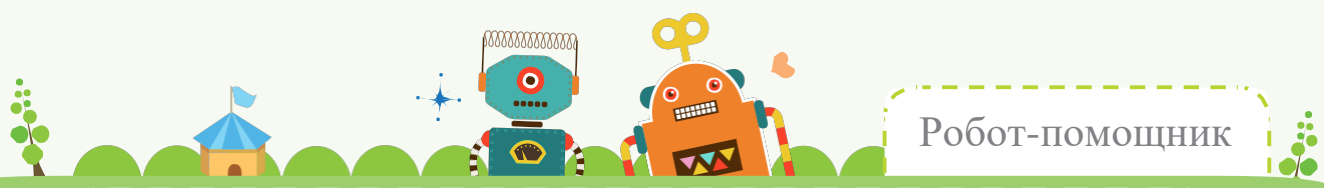

6 Детали



x1



x2



x2

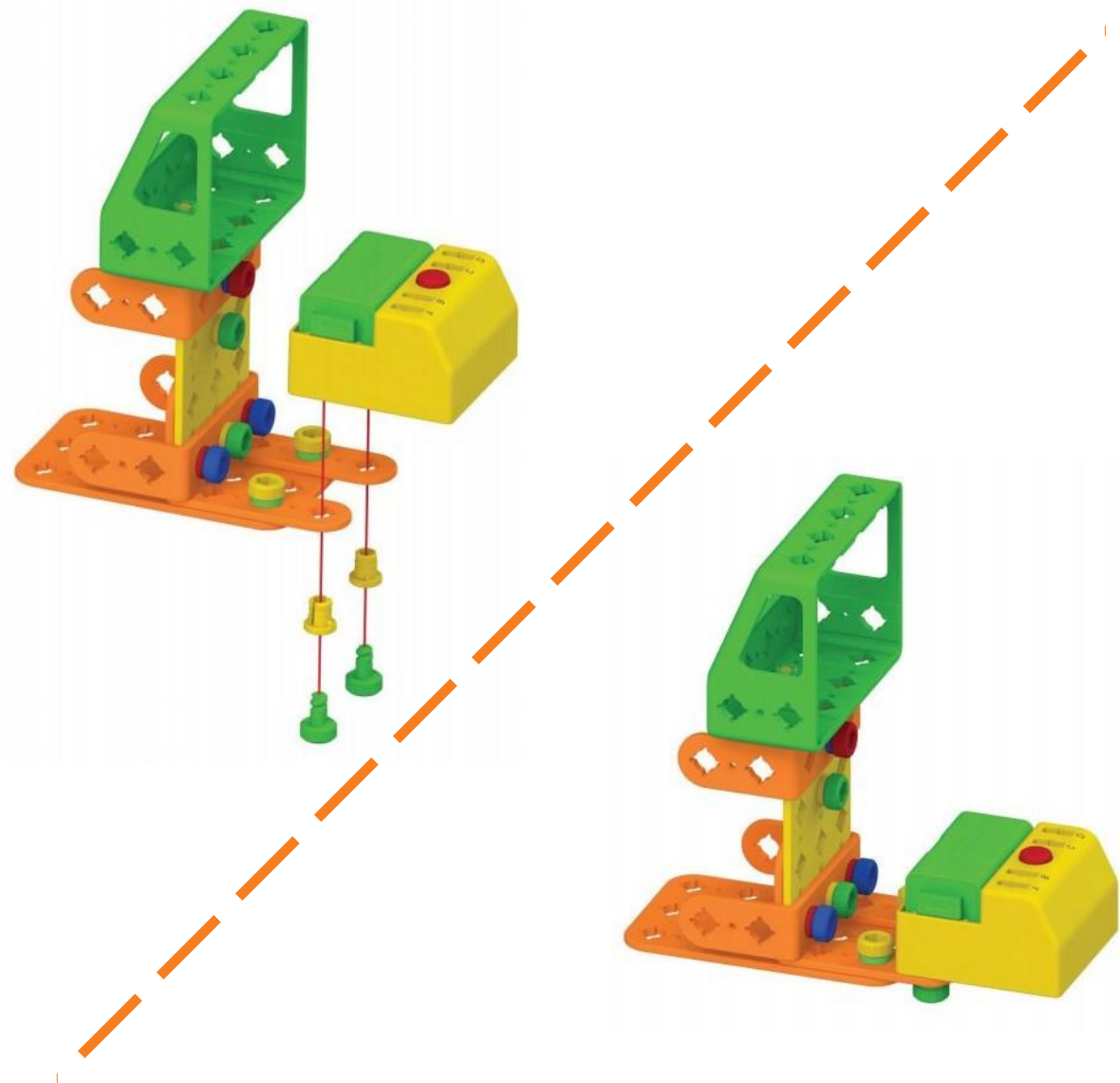

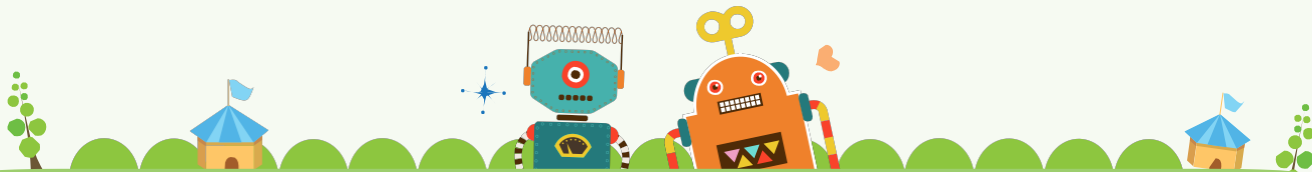

Детали



x1



x2



x2





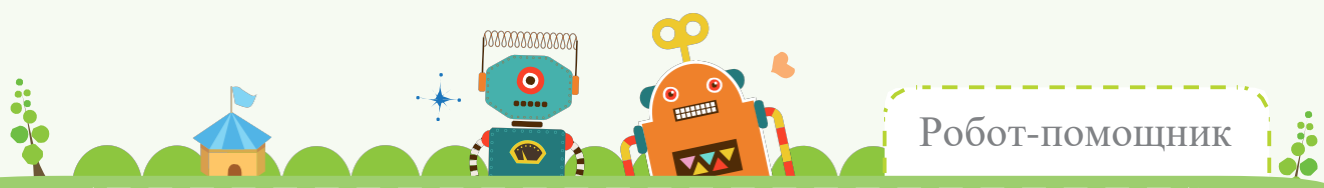

8 Детали



x2



x4



x4

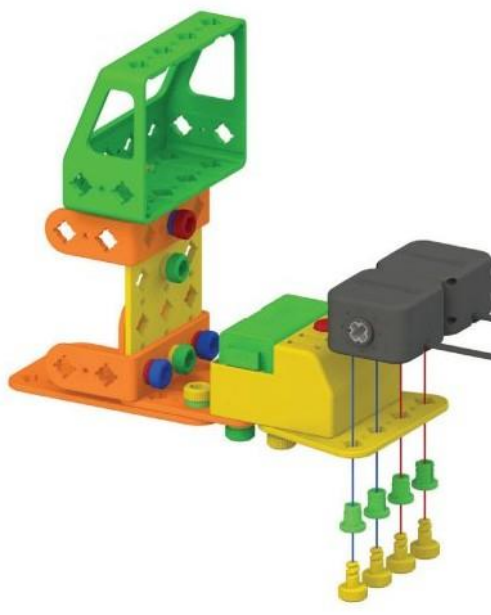

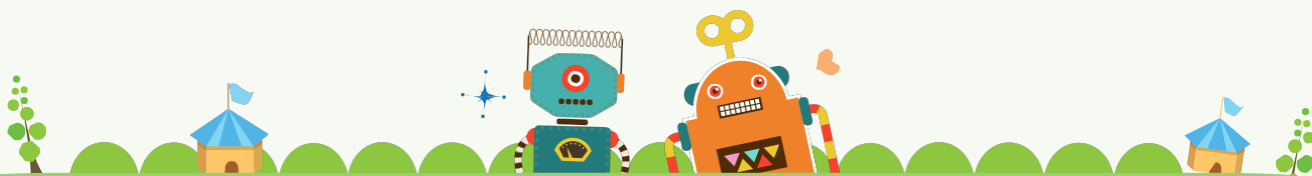

9

Детали



x1



x1



x2



x2

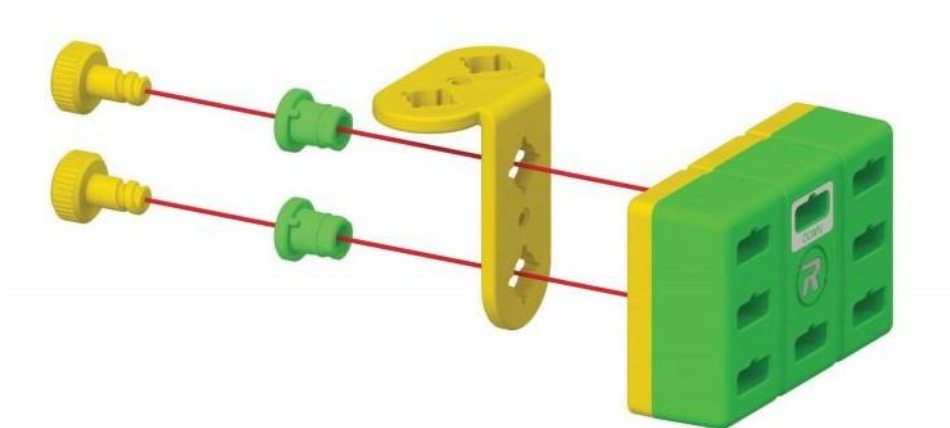

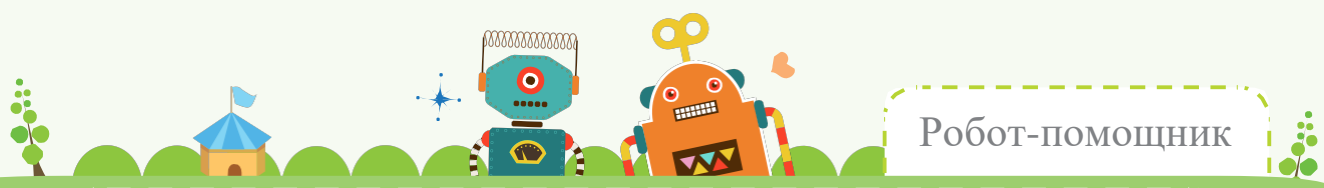

10 Детали



x2



x2



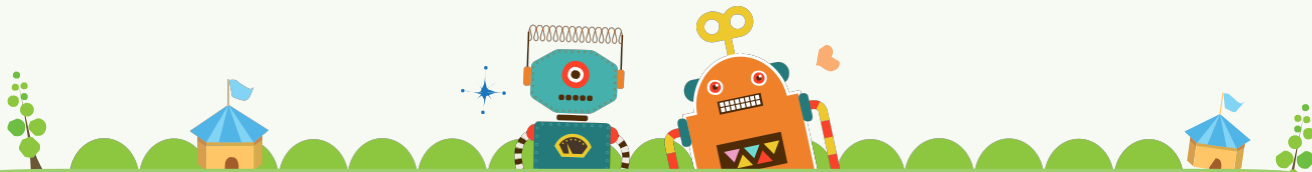

Детали



x2



x2



x2

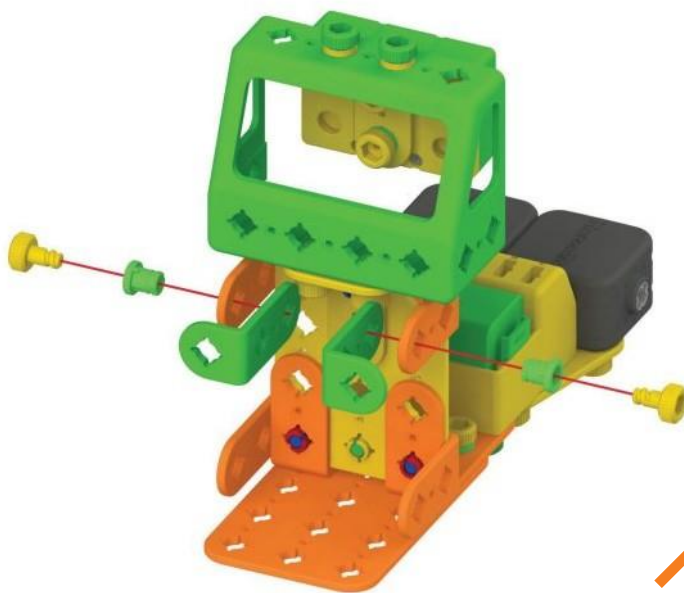

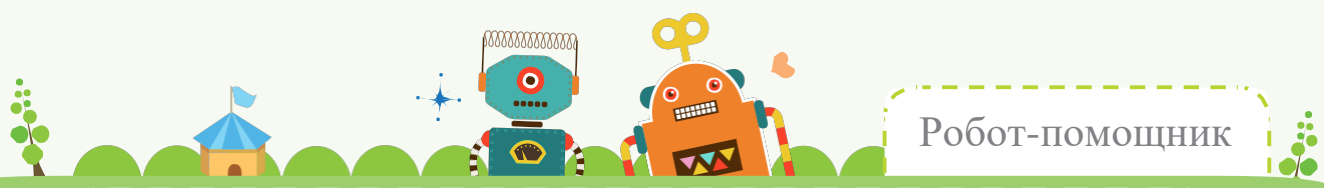

12

Детали



x2



x2



x2



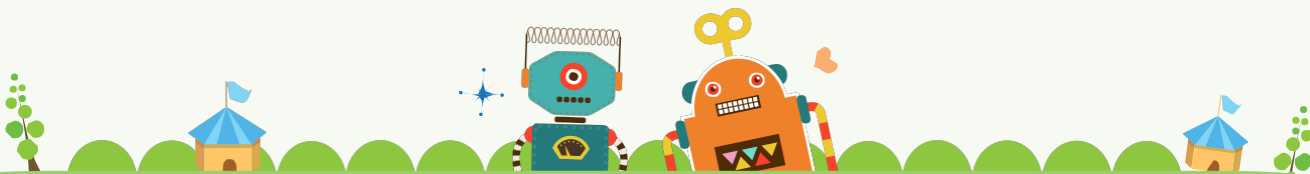

13

Детали



x2



x2



x2

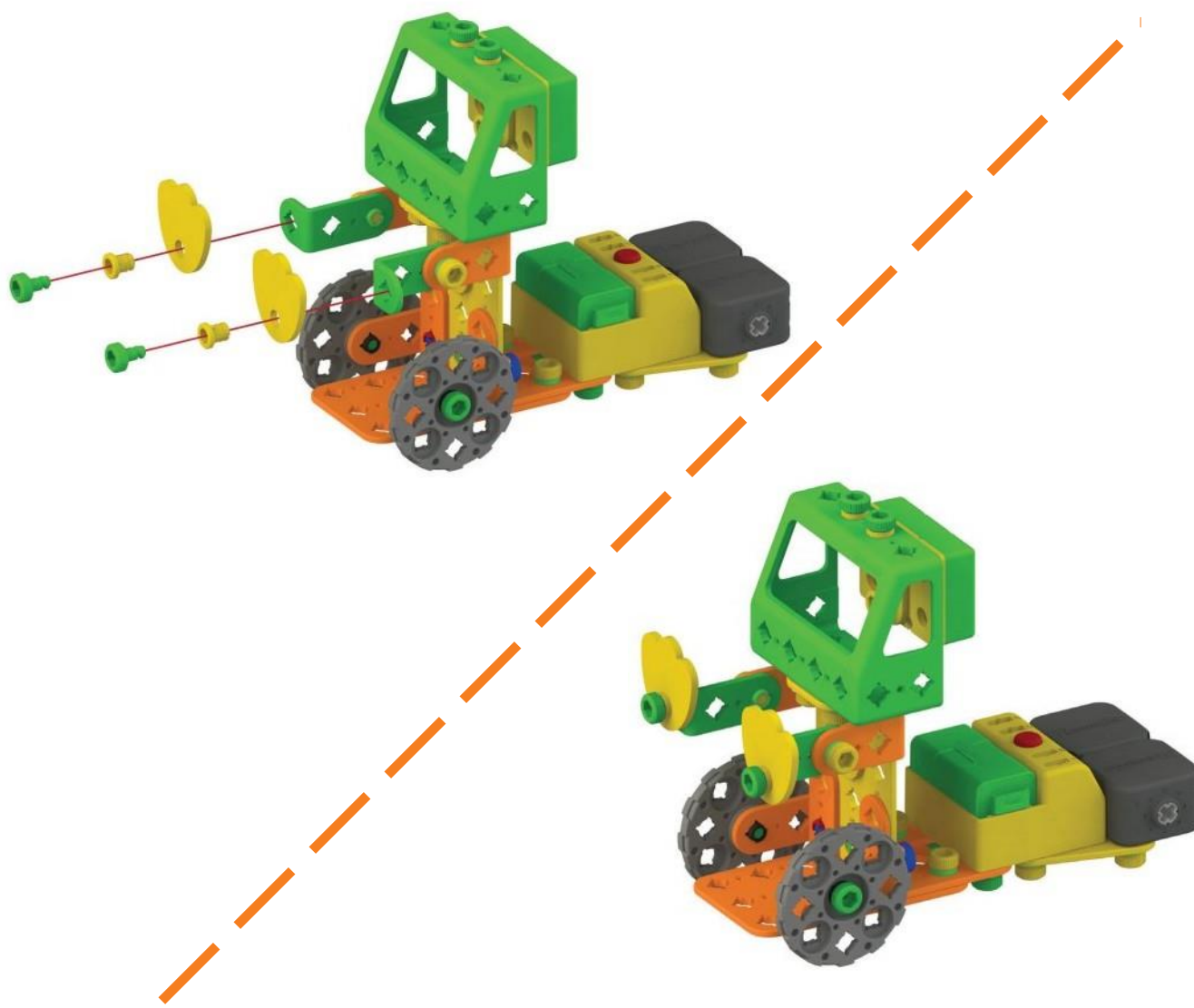



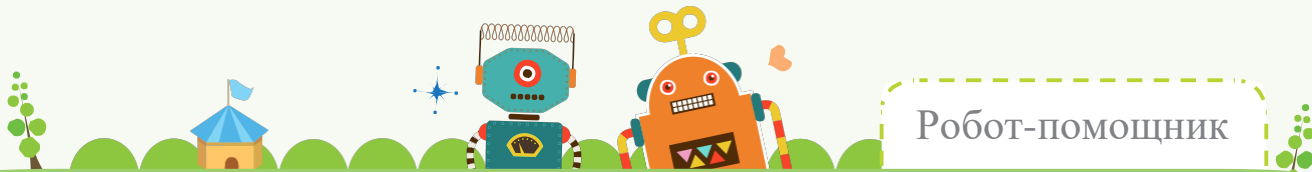

14

Детали



x1



x1



x1

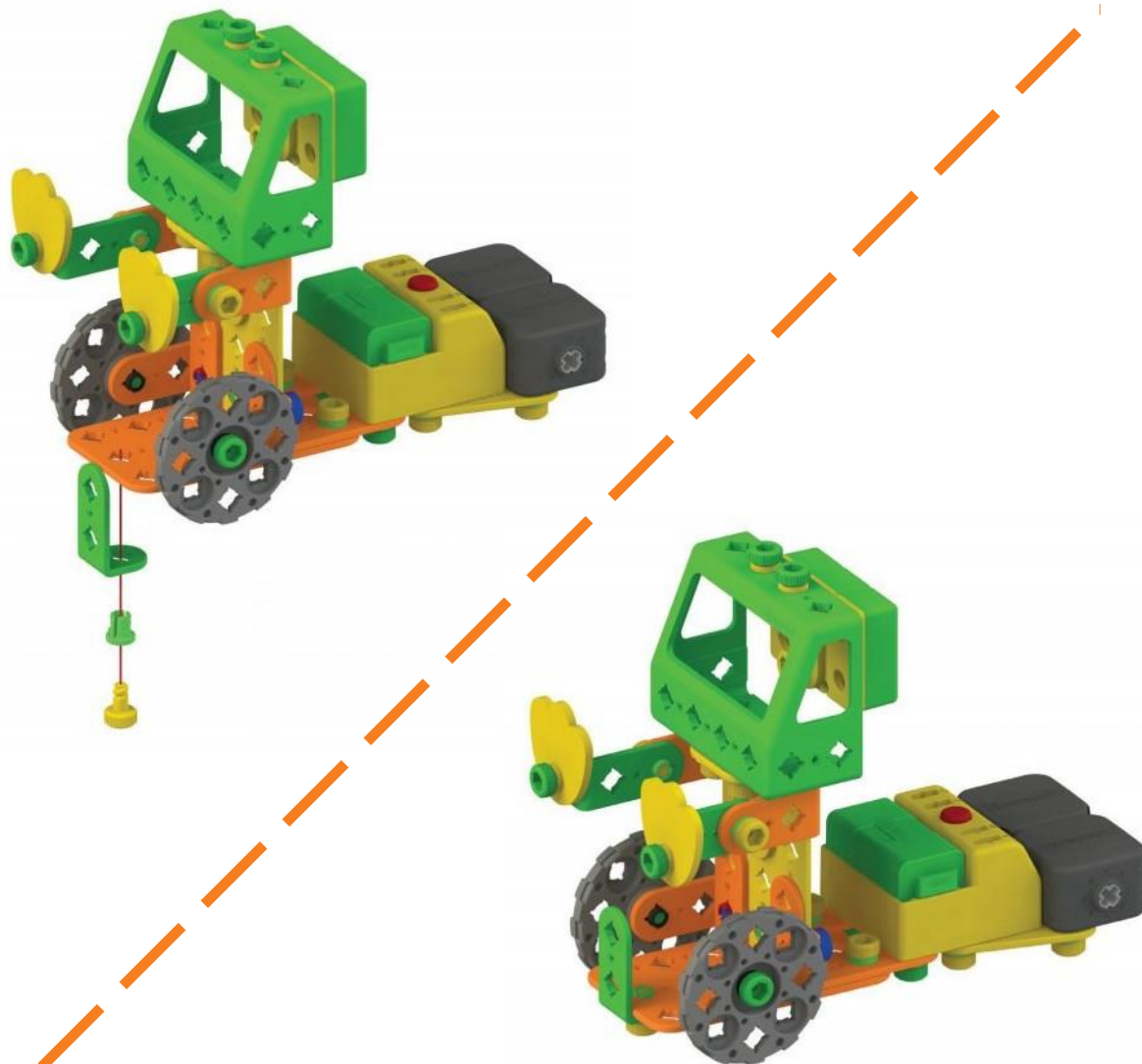

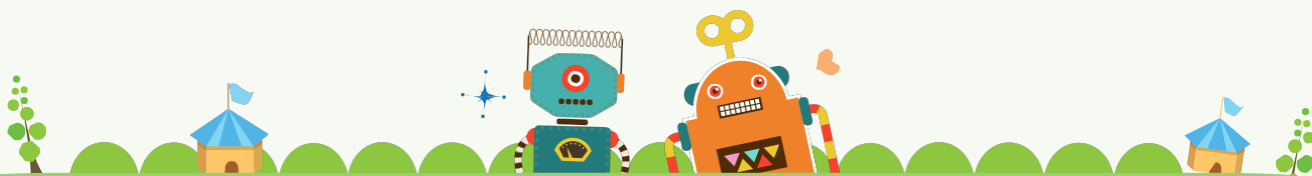

15

Детали



x2

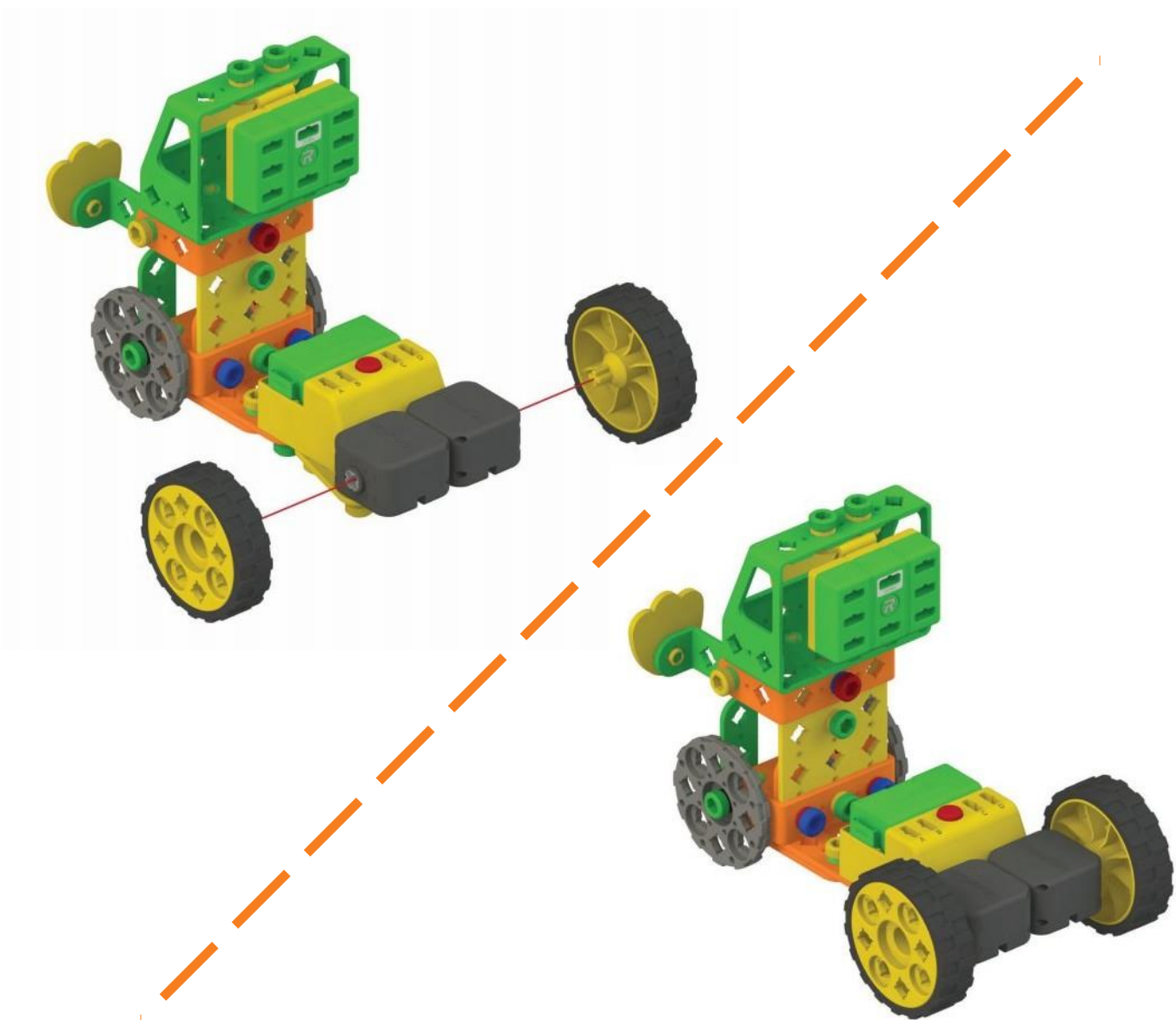

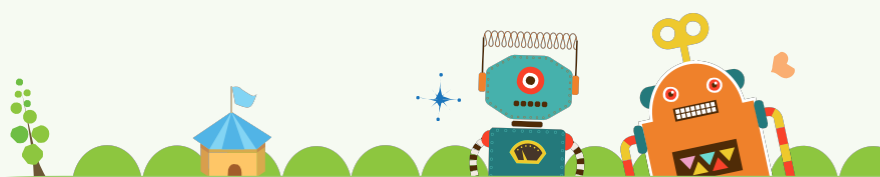

16 Детали



x1



x1



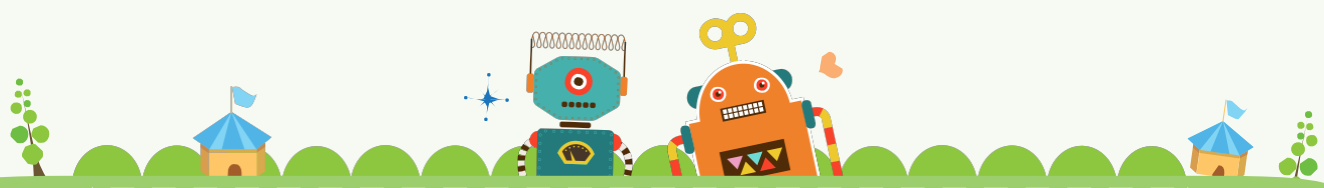

Двухсторонний кабель  
Подключите к порту D и ЦП

Левый  
электромотор  
Подключите к А

Правый  
электромотор  
Подключите к В

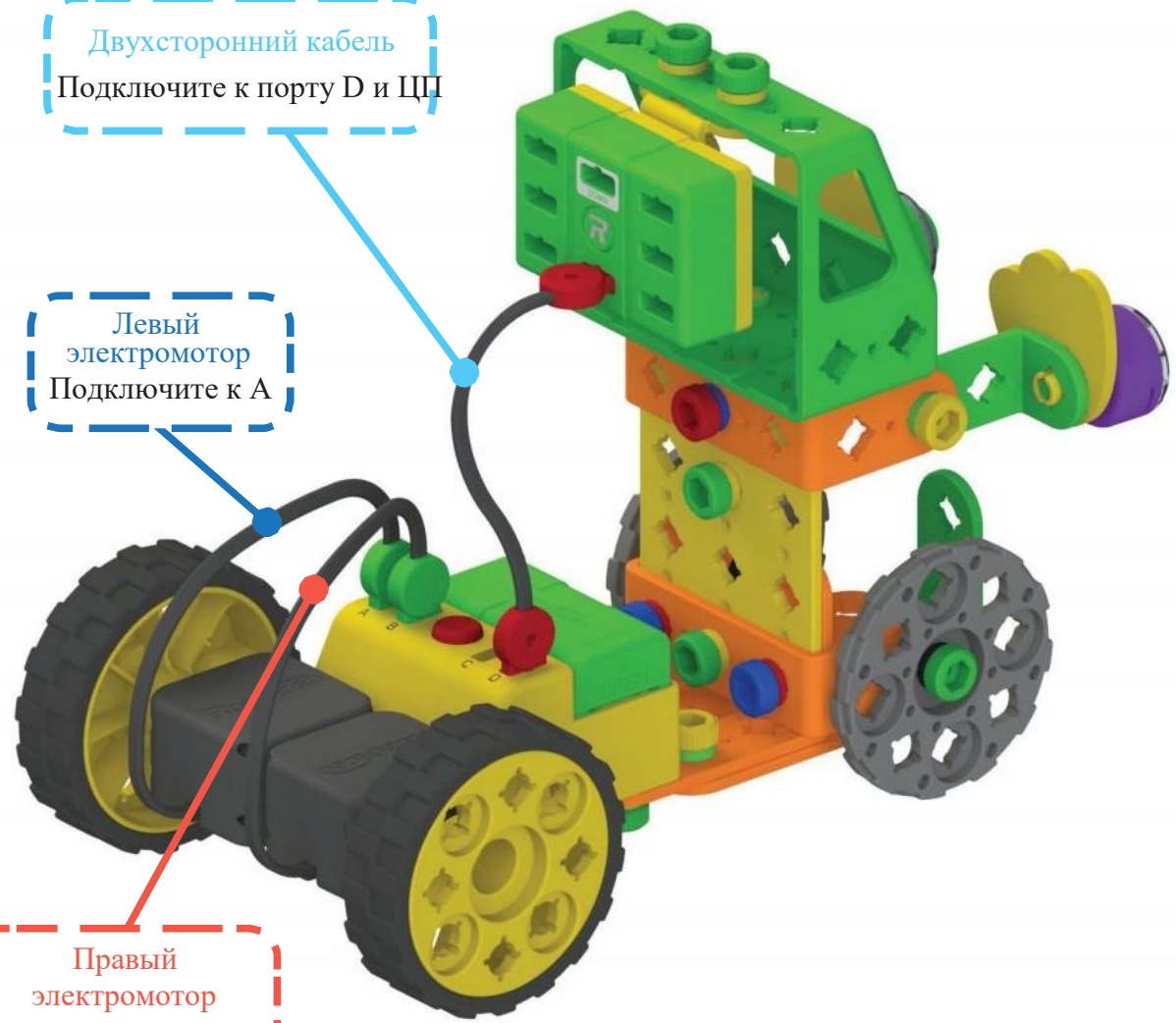

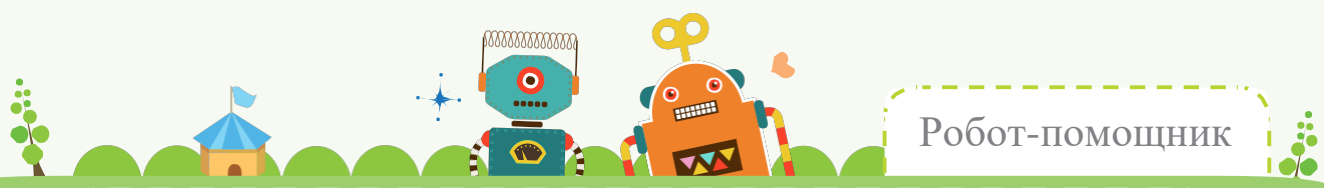

Робот-помощник

Инфракрасный датчик  
Подключите к ЦП

Контактный датчик (G)  
Подключите к ЦП

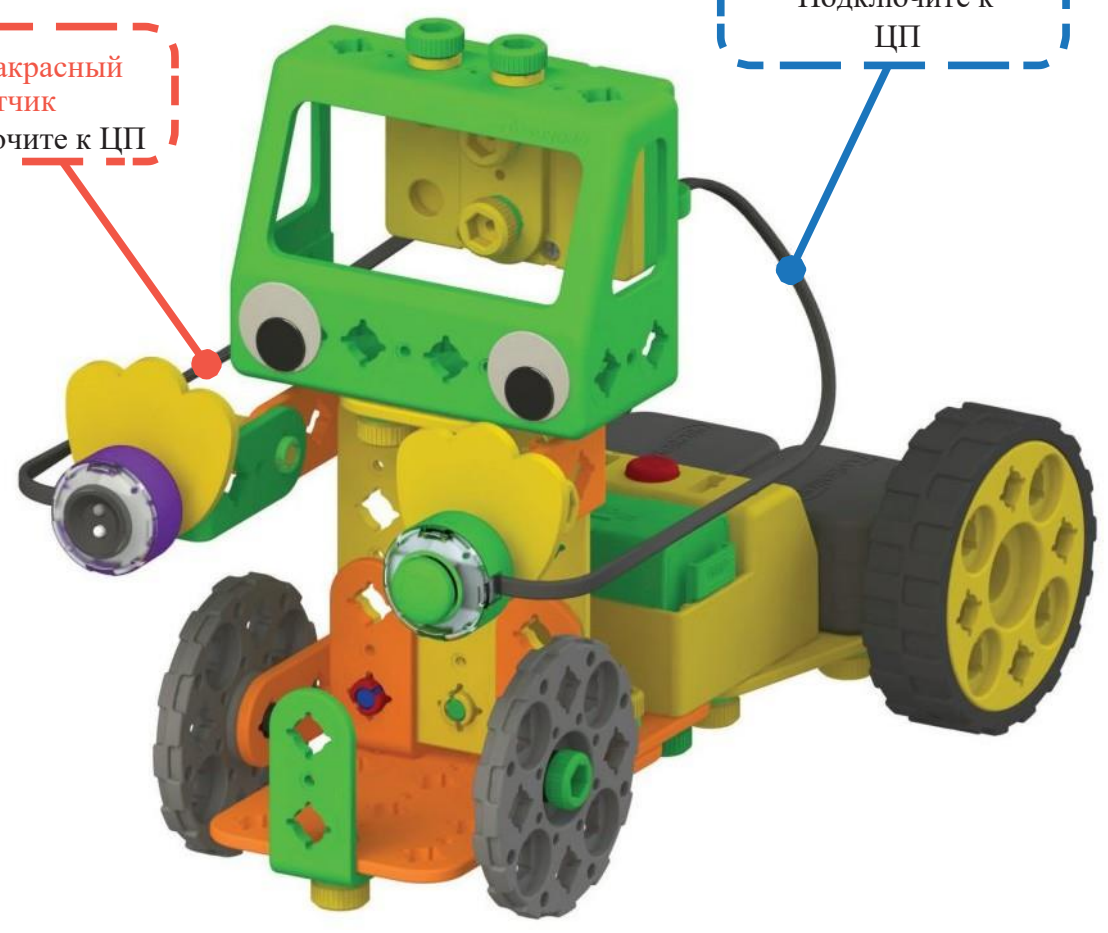





Запрограммируем движение робота помощника на программной плате.

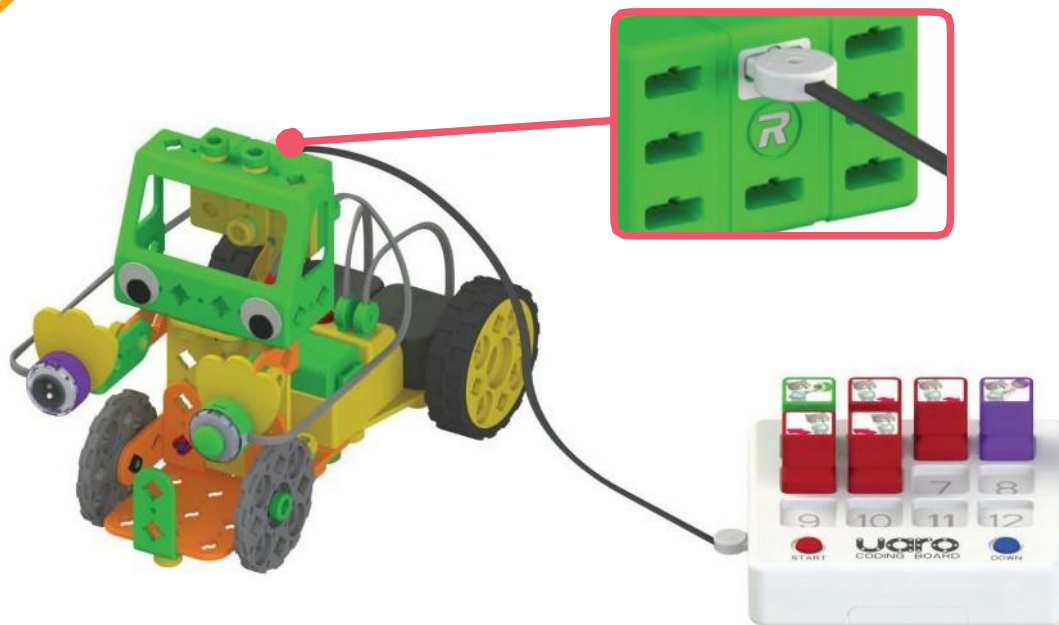

Робот будет приносить коробки при нажатии на контактный датчик. И он вернется в исходное положение, если зафиксирован инфракрасный датчик.



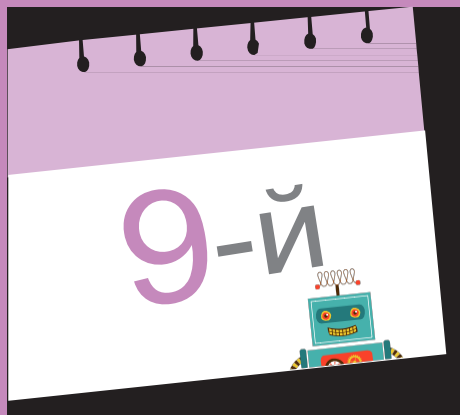

Отправимся в прогулку на яхте!

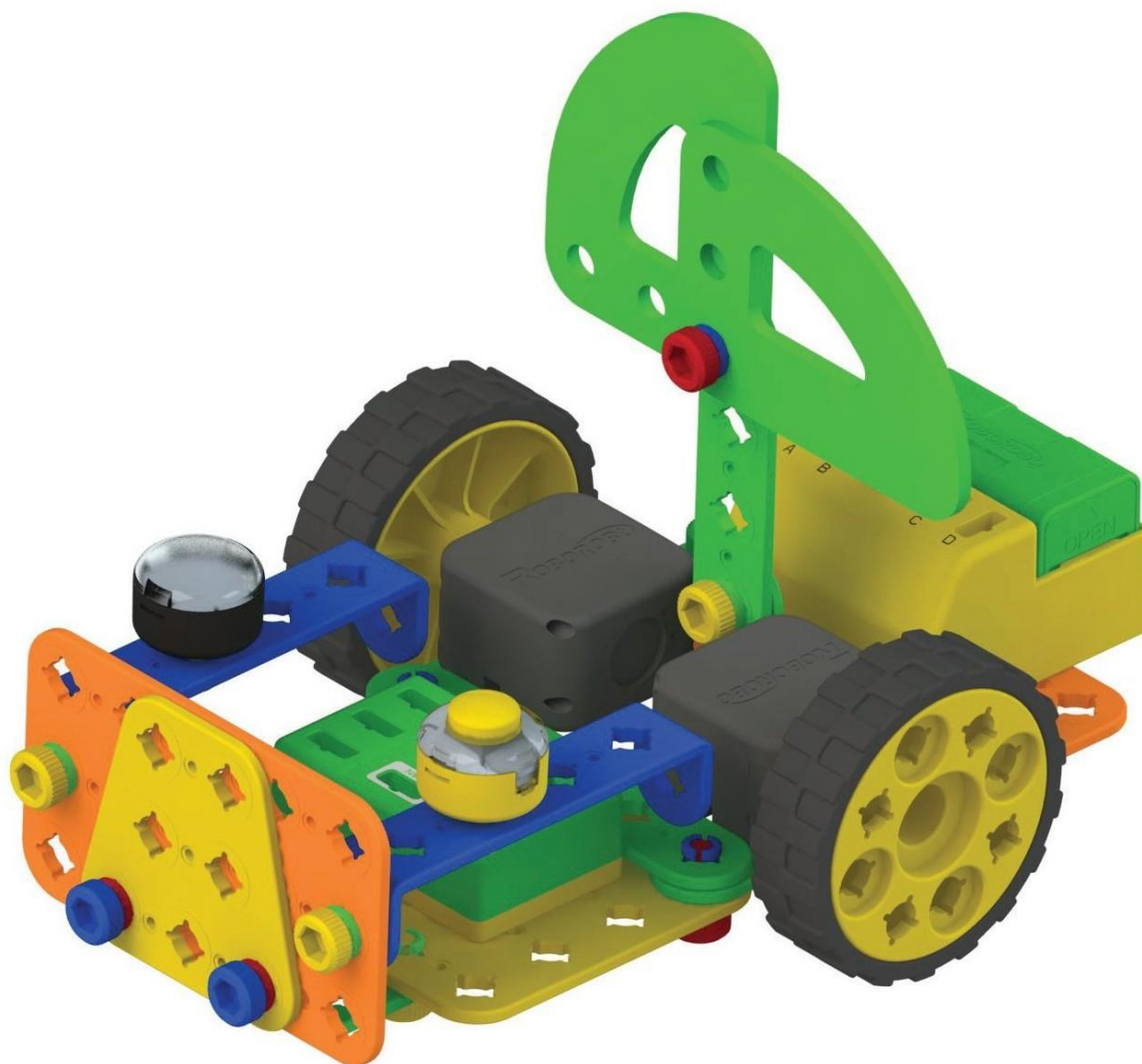

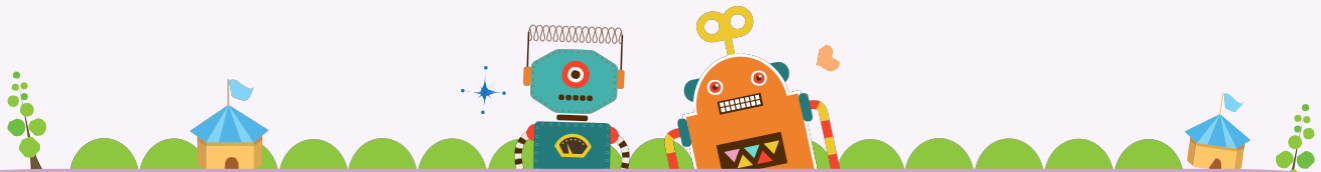

Детали



x1



x1



x2



x2

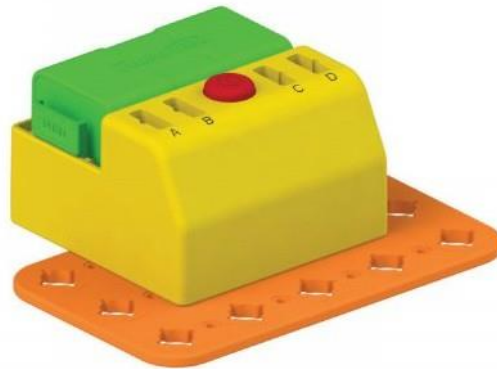
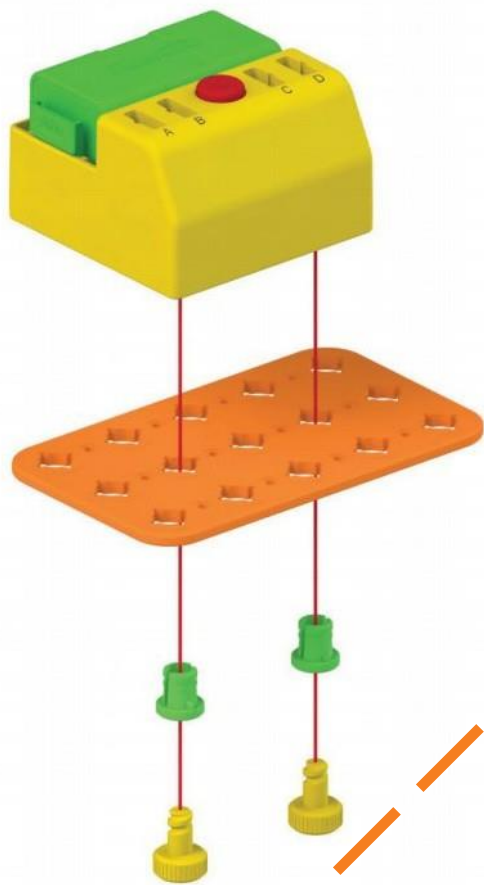

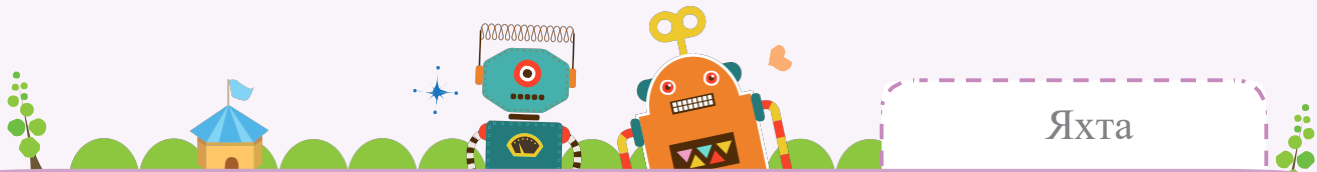

2

Детали

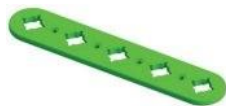

x2



x4



x4

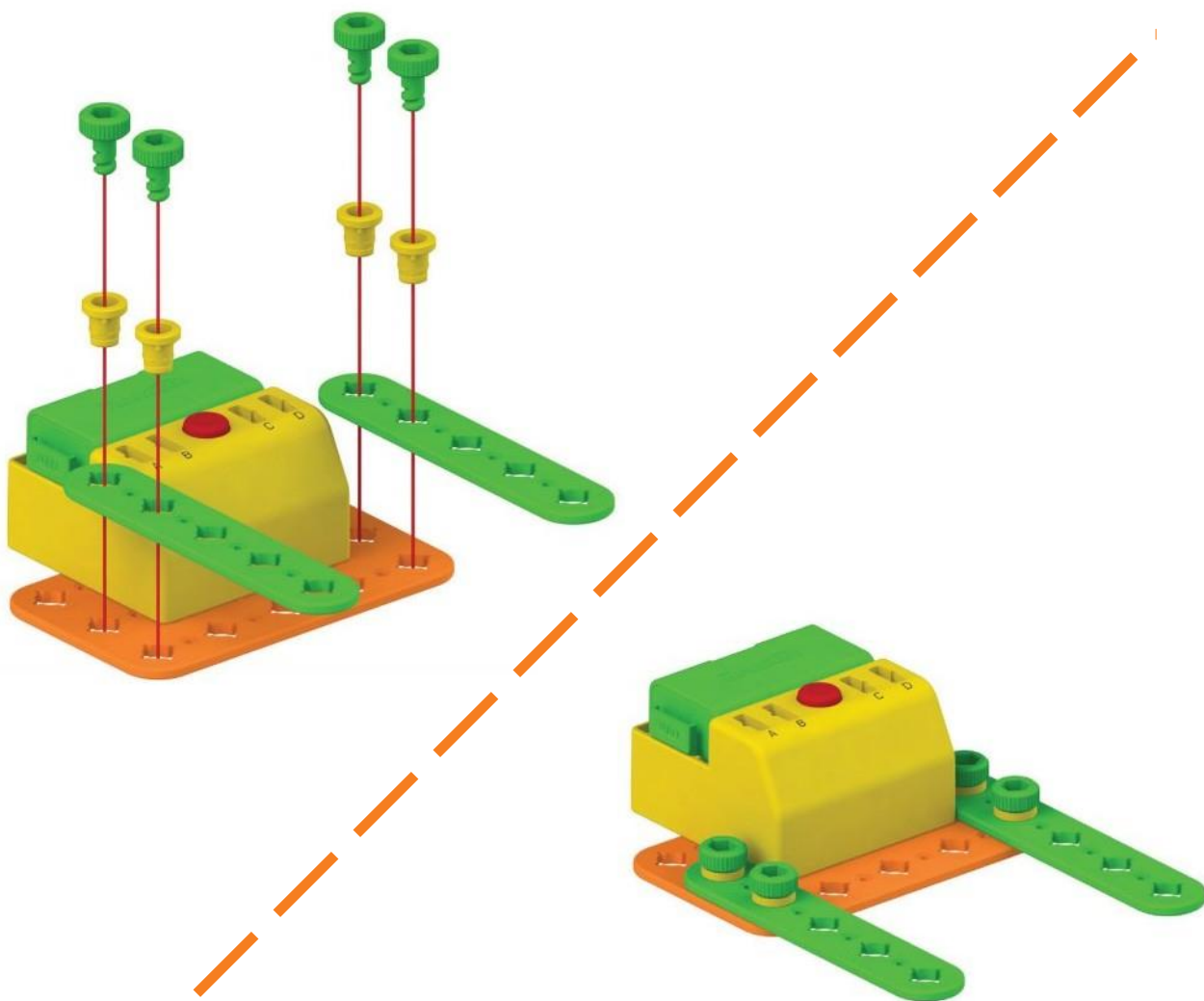

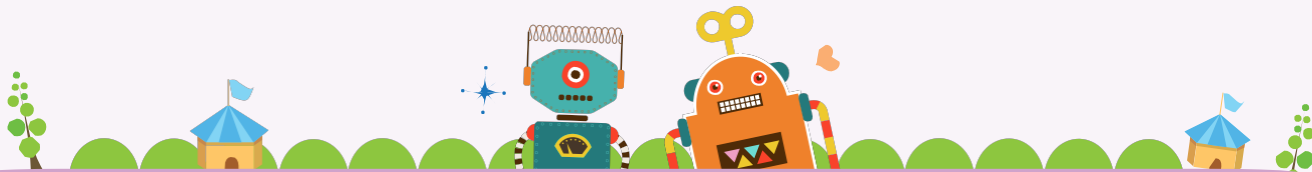

3

Детали



x1



x1



x1

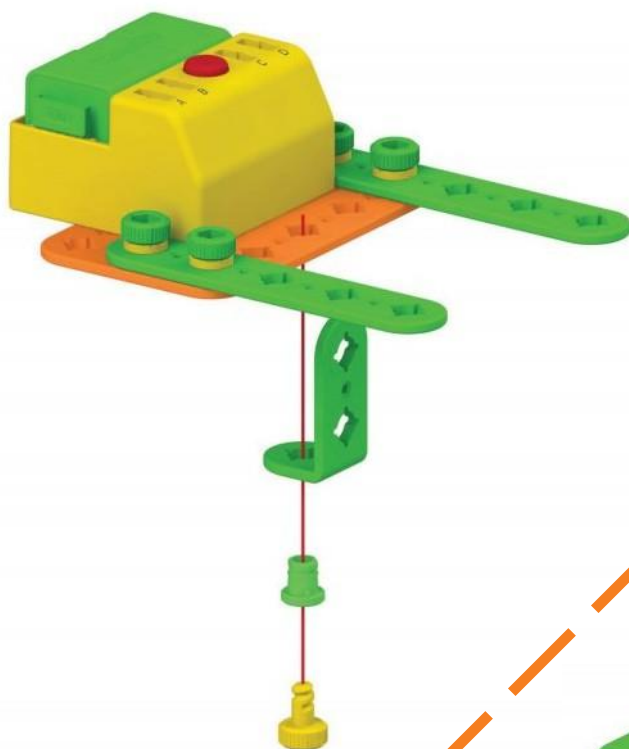

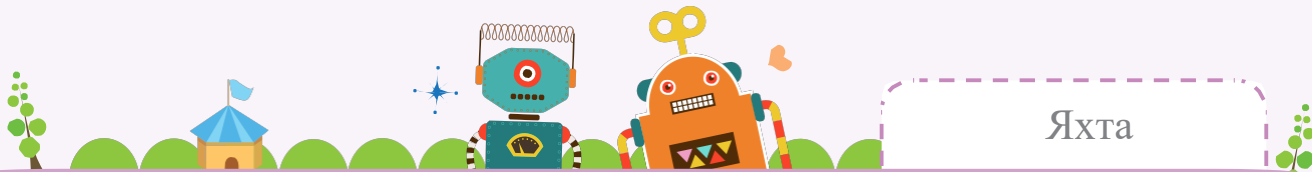

4

Детали



x1



x2



x1



x1



x1



x1

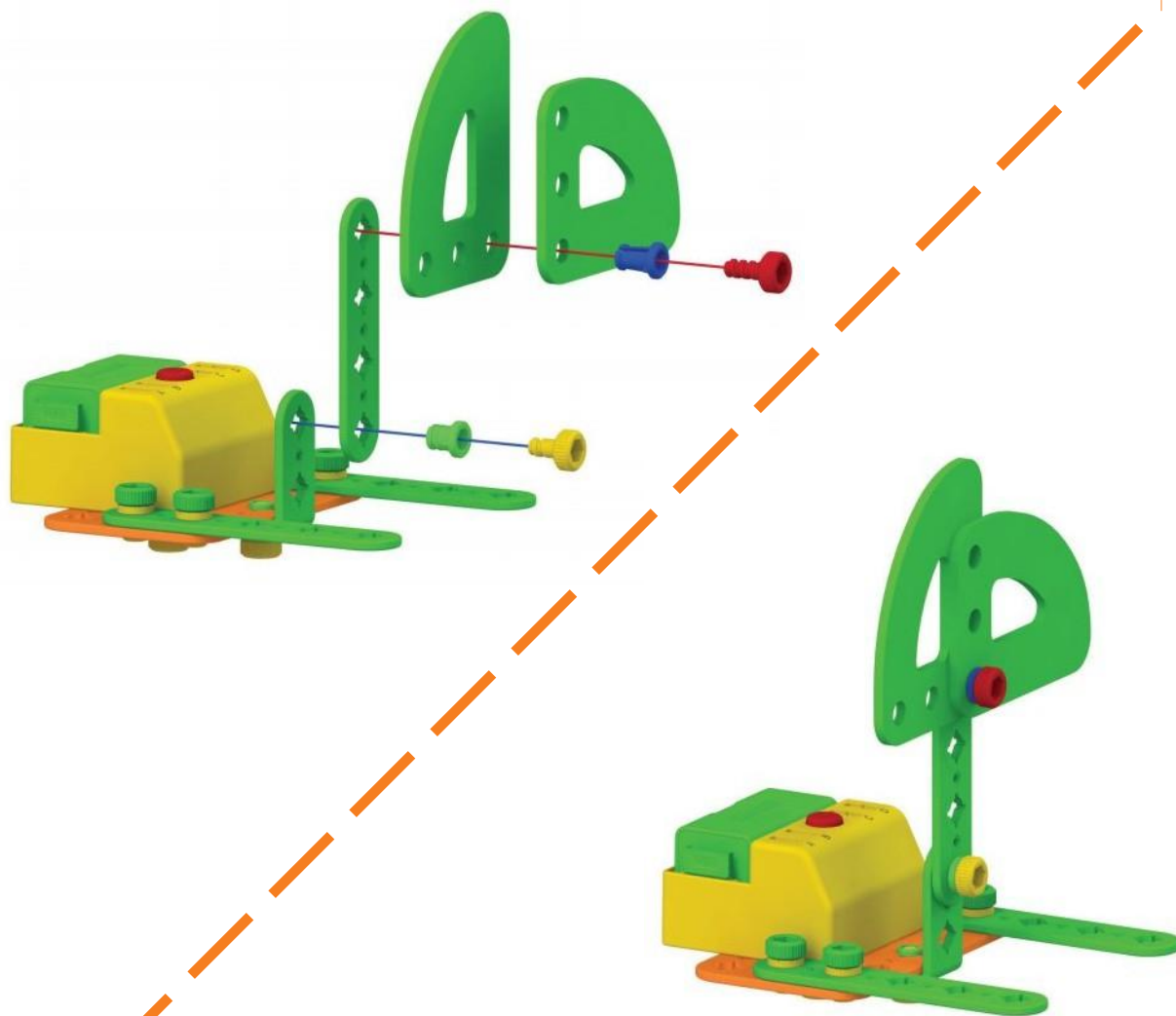

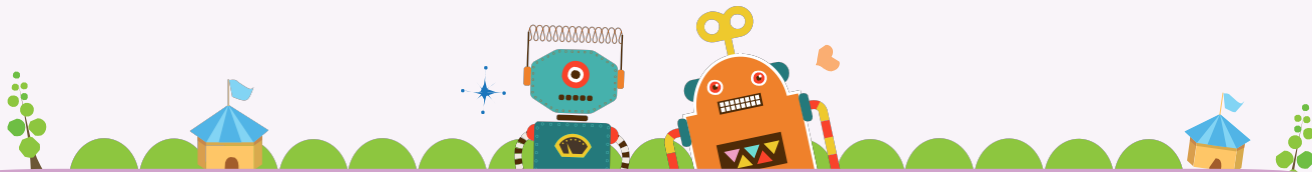

5

Детали



x2



x4



x4

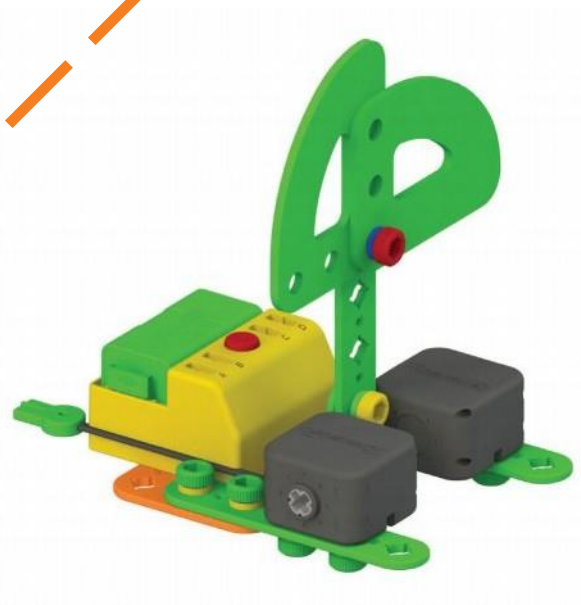
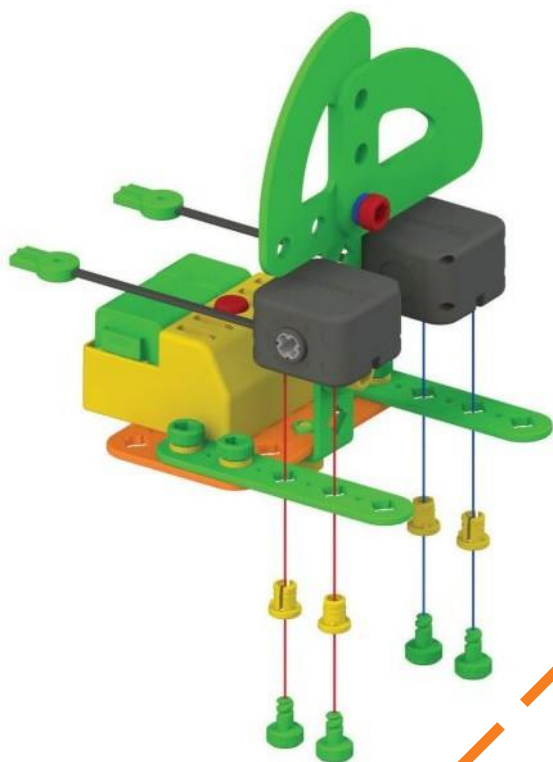



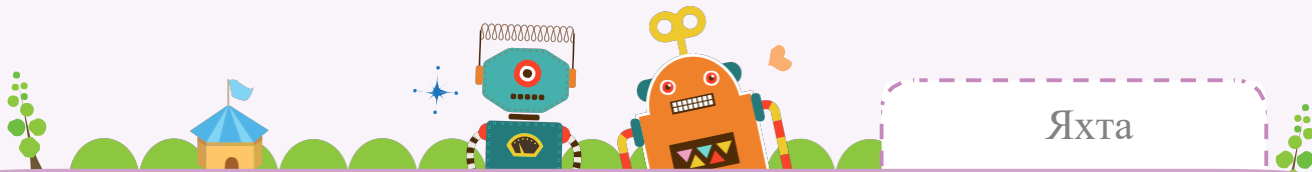

6

Детали

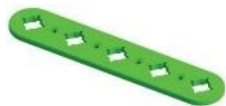

x1

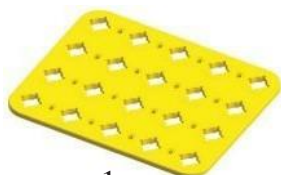

x1



x2



x2

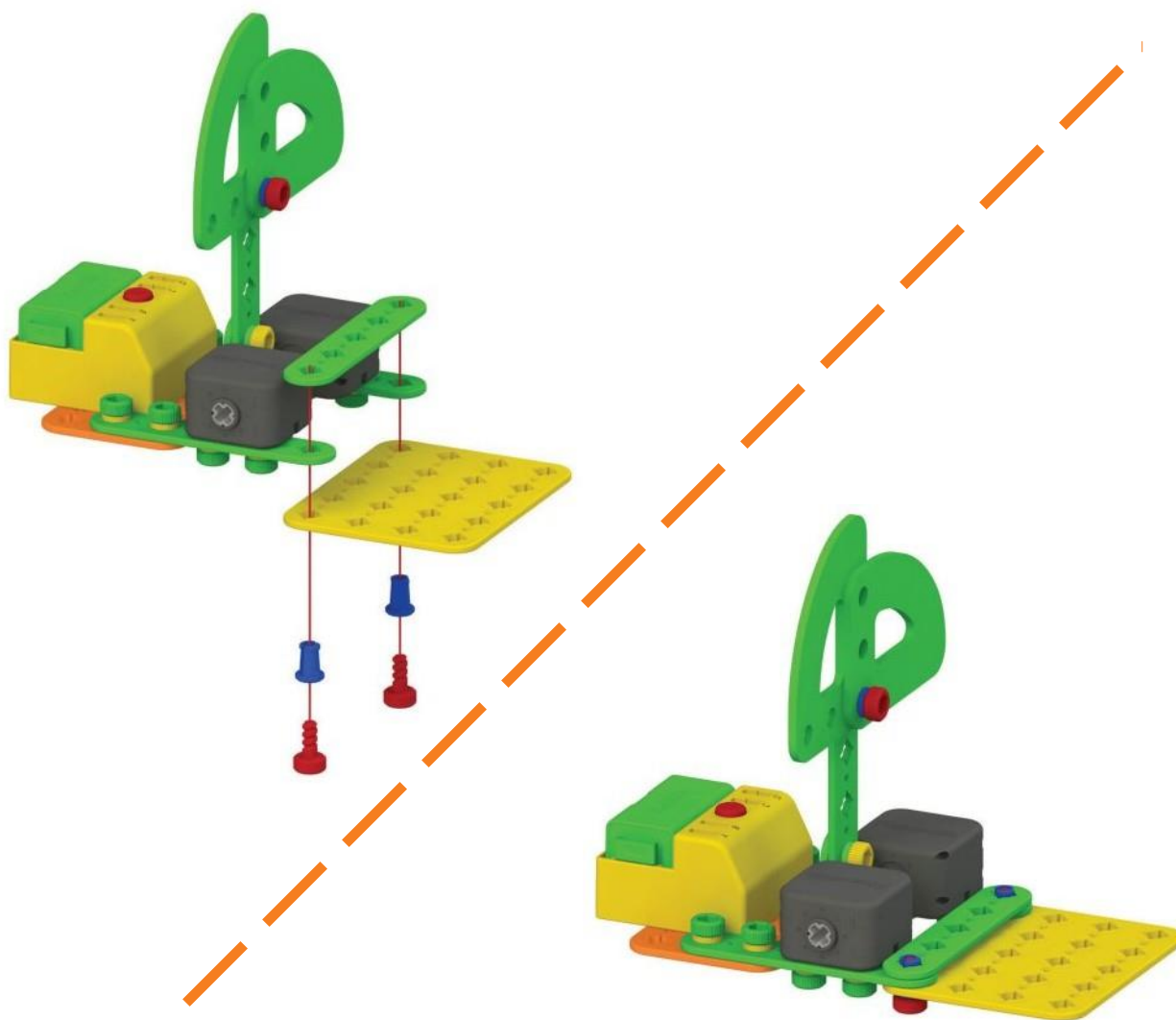

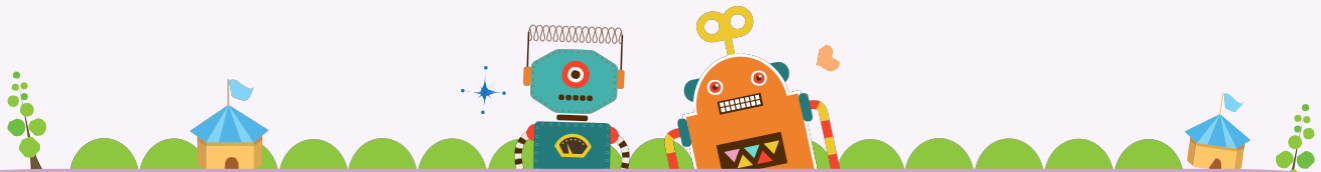

Детали



x1



x2



x2

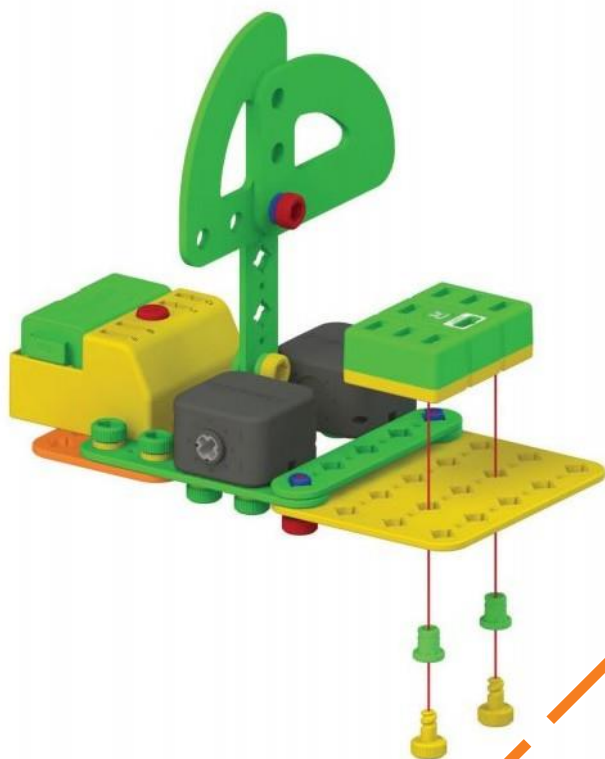

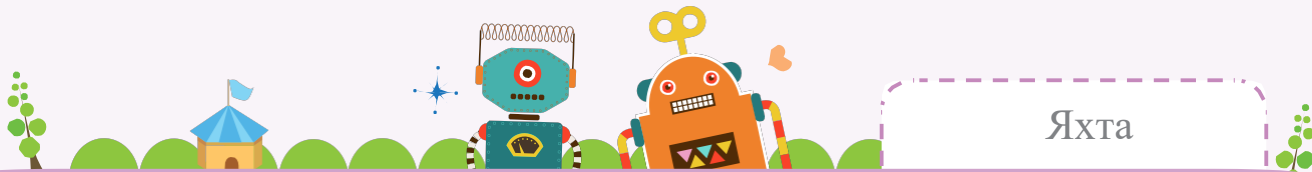

8

Детали



x2



x2



x2

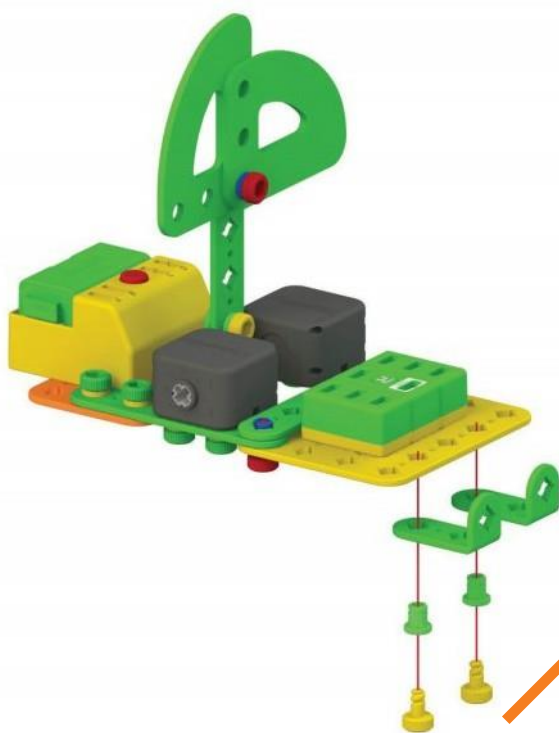

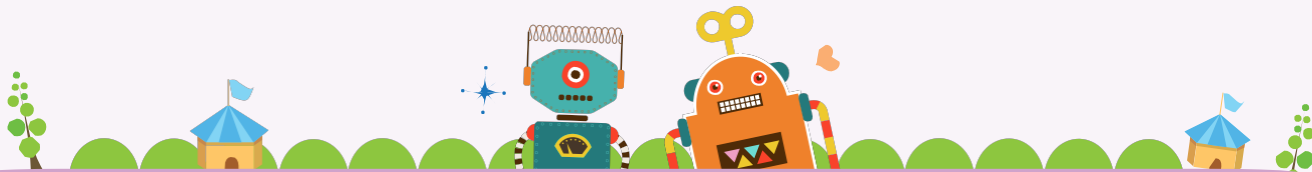

9

Детали



x1



x1



x2



x2

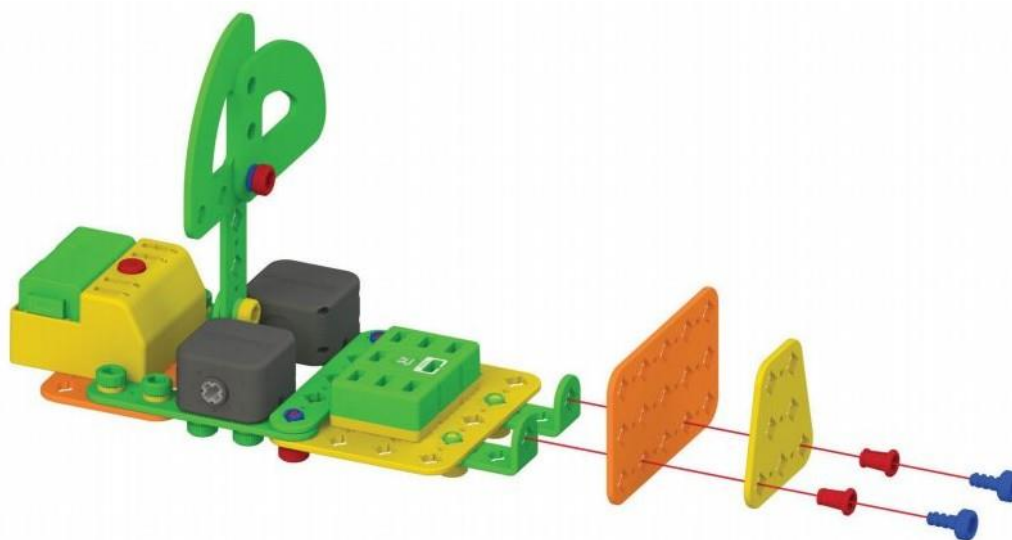

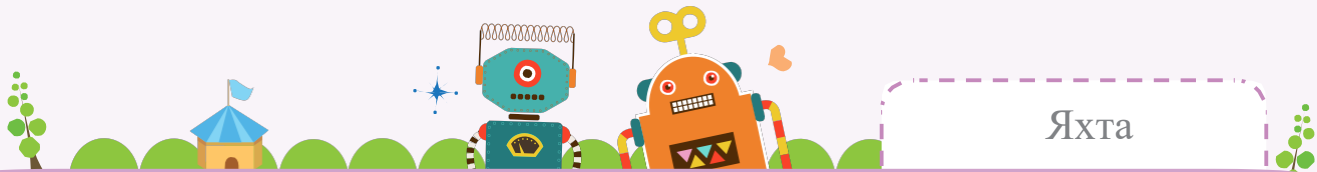

10

Детали



x2



x2



x2

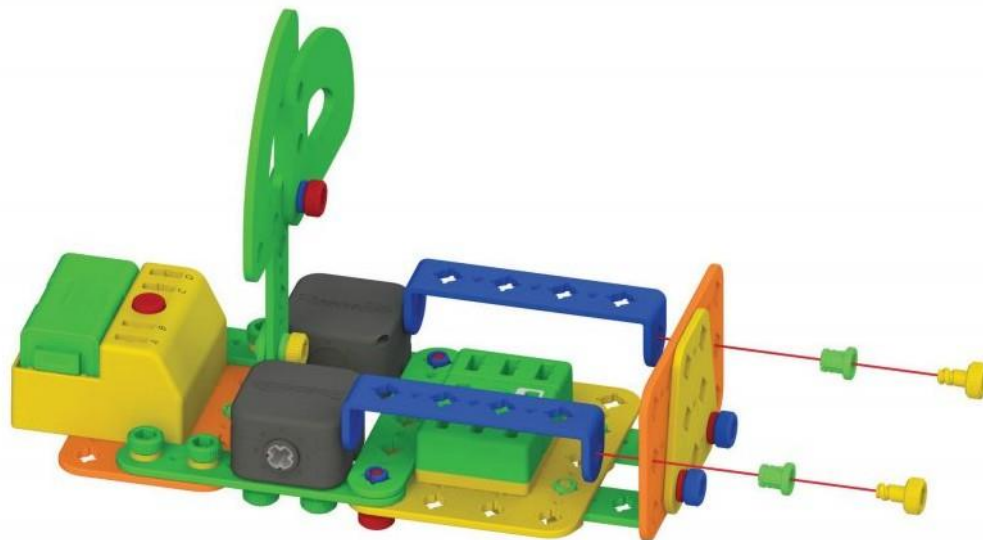

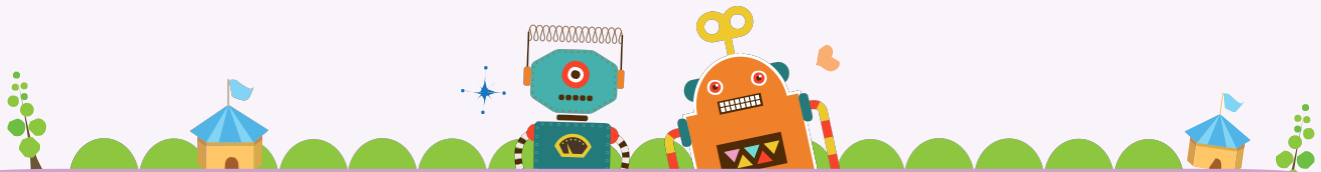

Детали



x2



x2



x1



x1





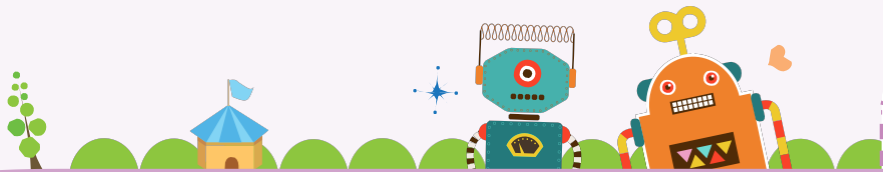

12

Детали



x2

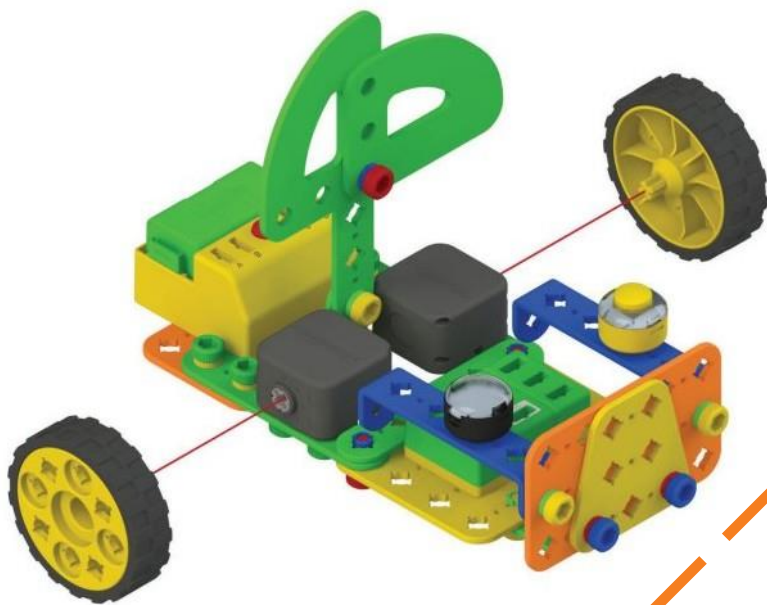

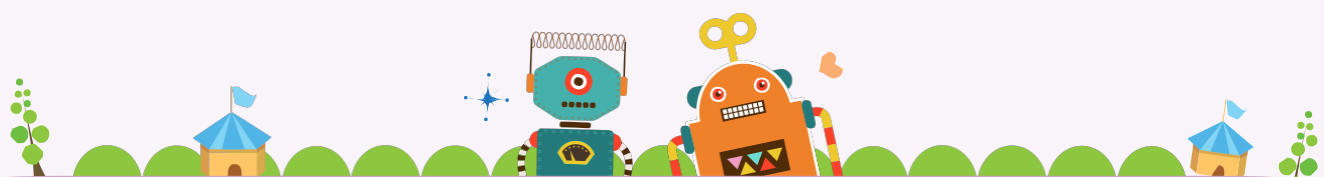

Левый электромотор  
Подключите к А

Двухсторонний кабель  
Подключите к порту D и ЦП

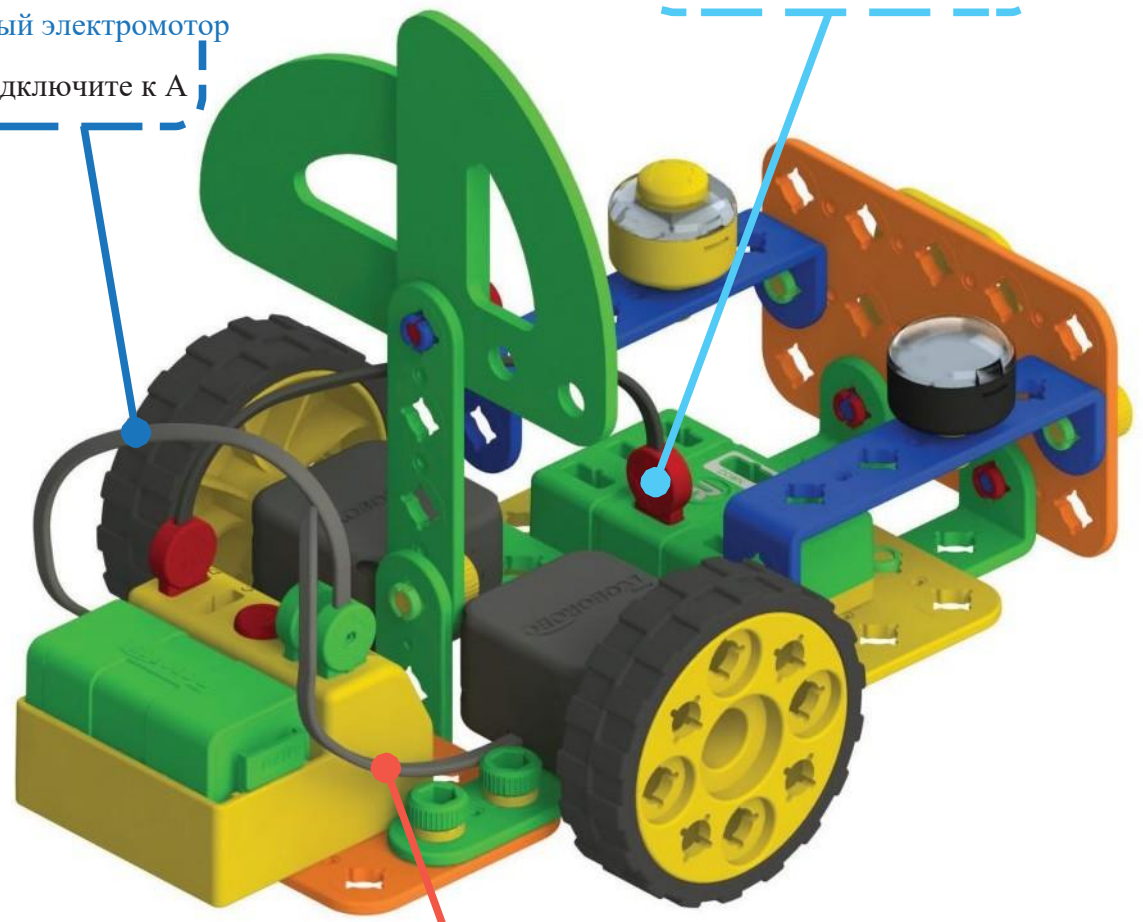

Правый электромотор  
Подключите к В

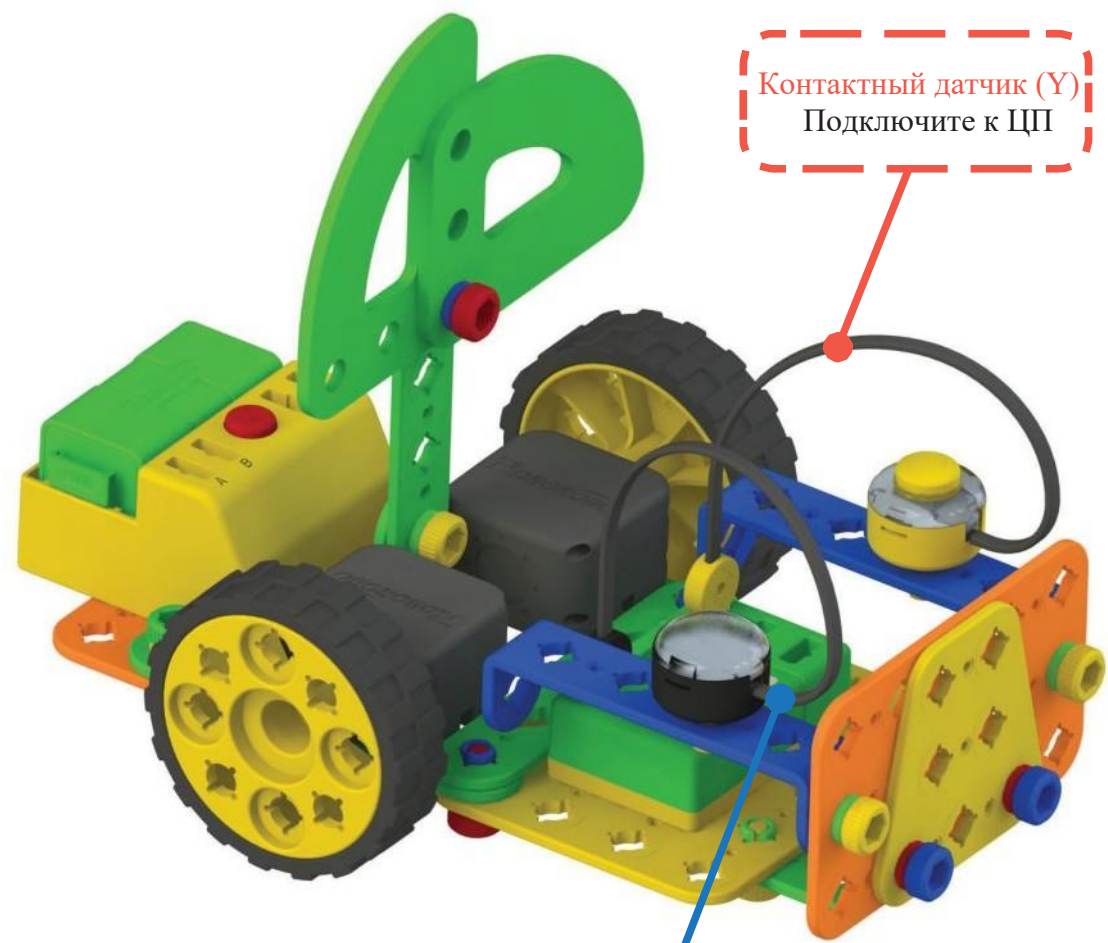
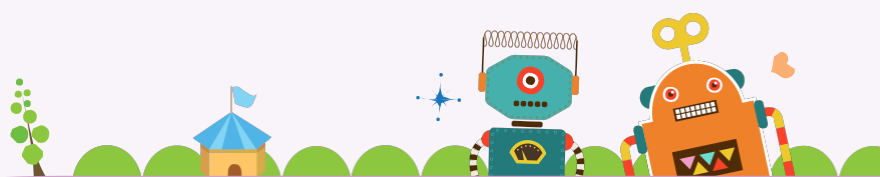

Контактный датчик (У)  
Подключите к ЦП

Плата дистанционного  
приемника  
Подключите к ЦП



Запрограммируем движение яхты на программной плате.

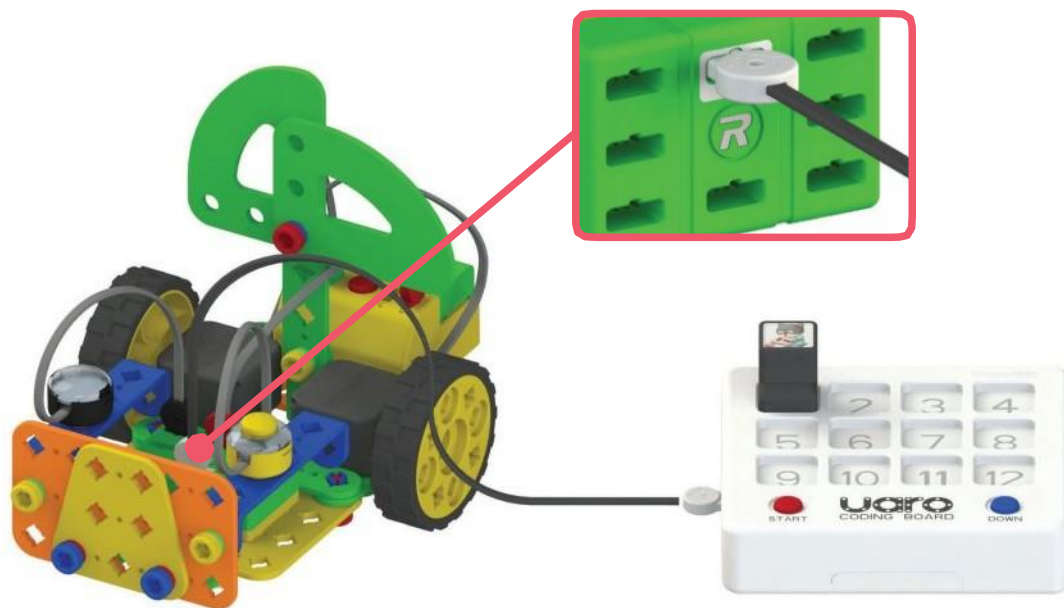

Управляйте яхтой с помощью устройства дистанционного управления

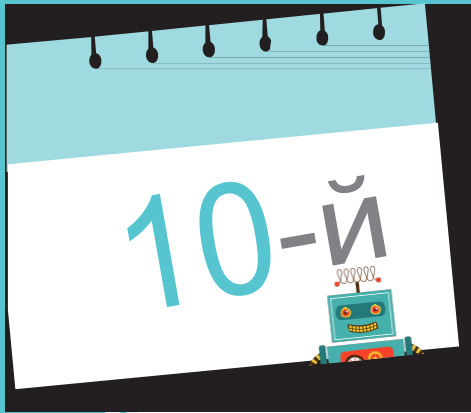

Прокатимся на велосипеде!

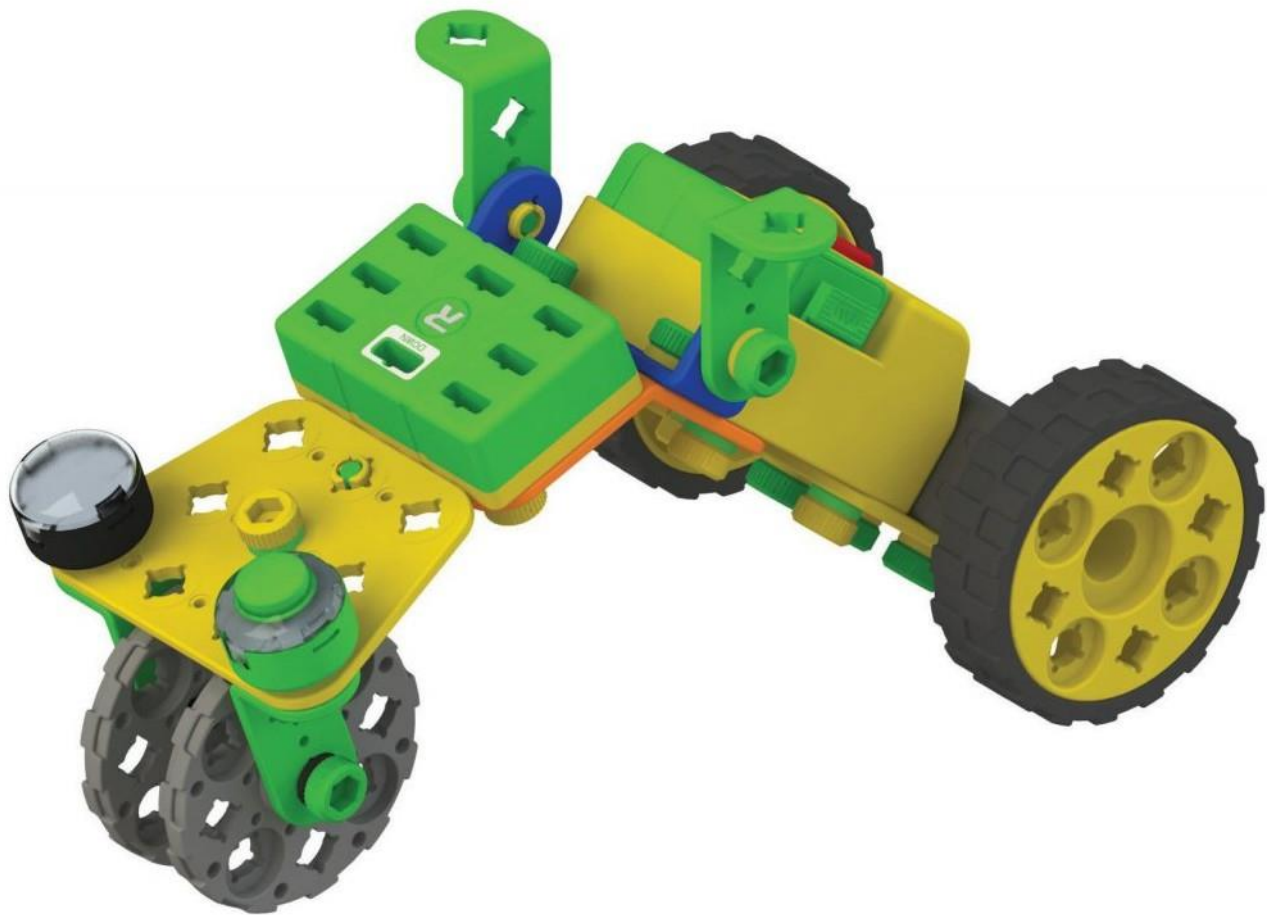



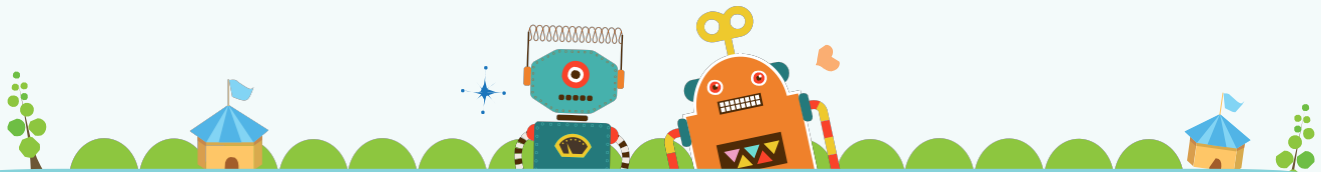

Детали



x1



x1



x1



x1

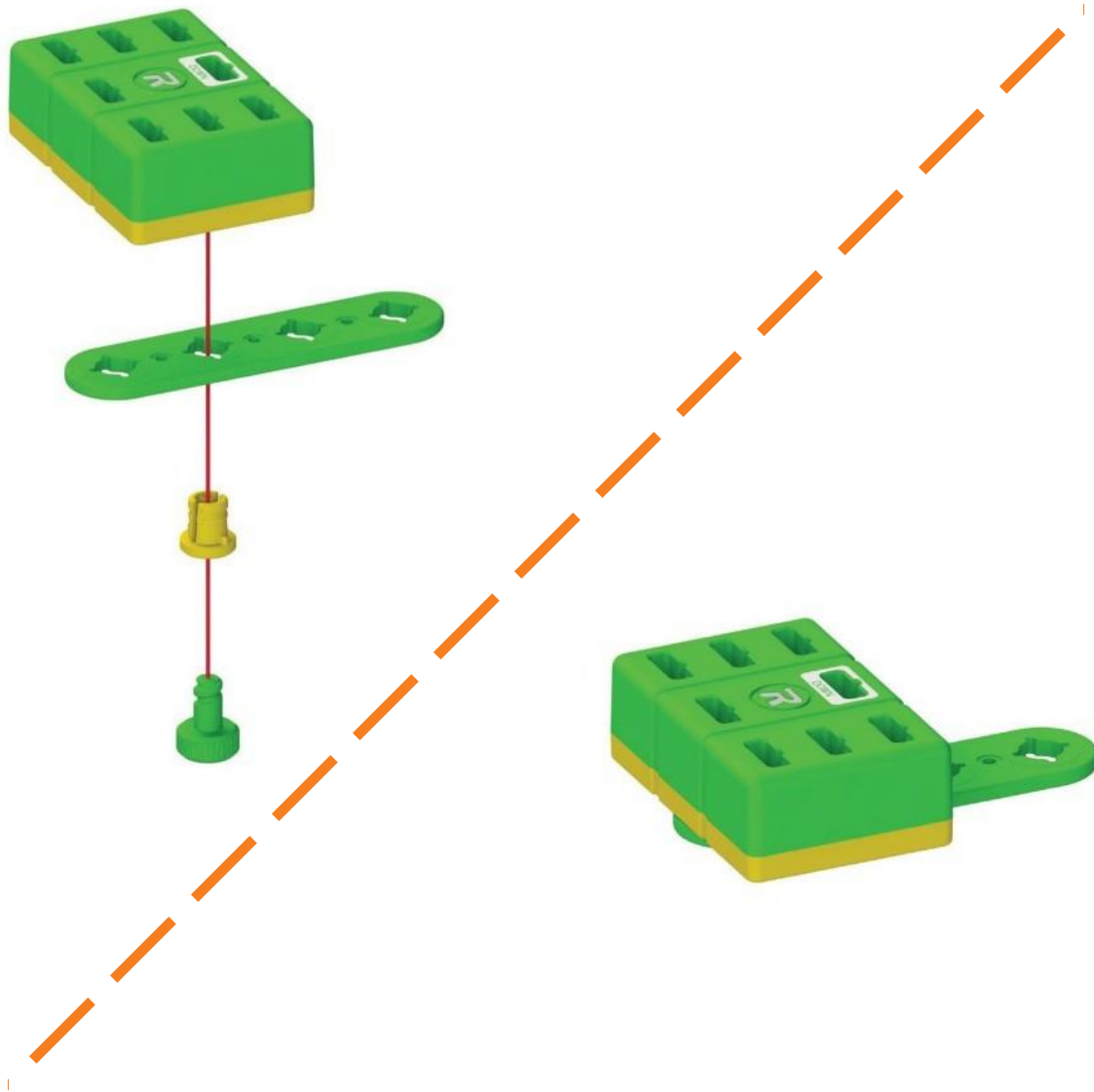



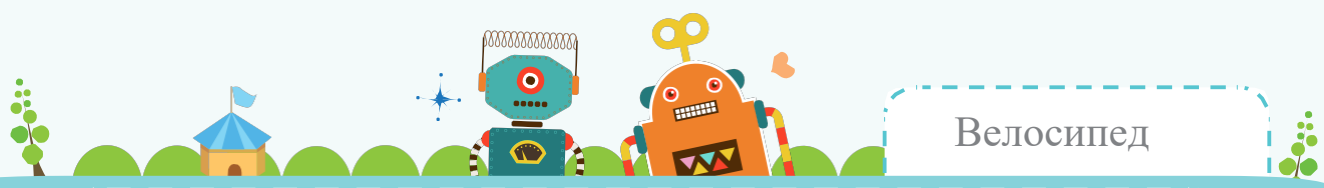

2 Детали

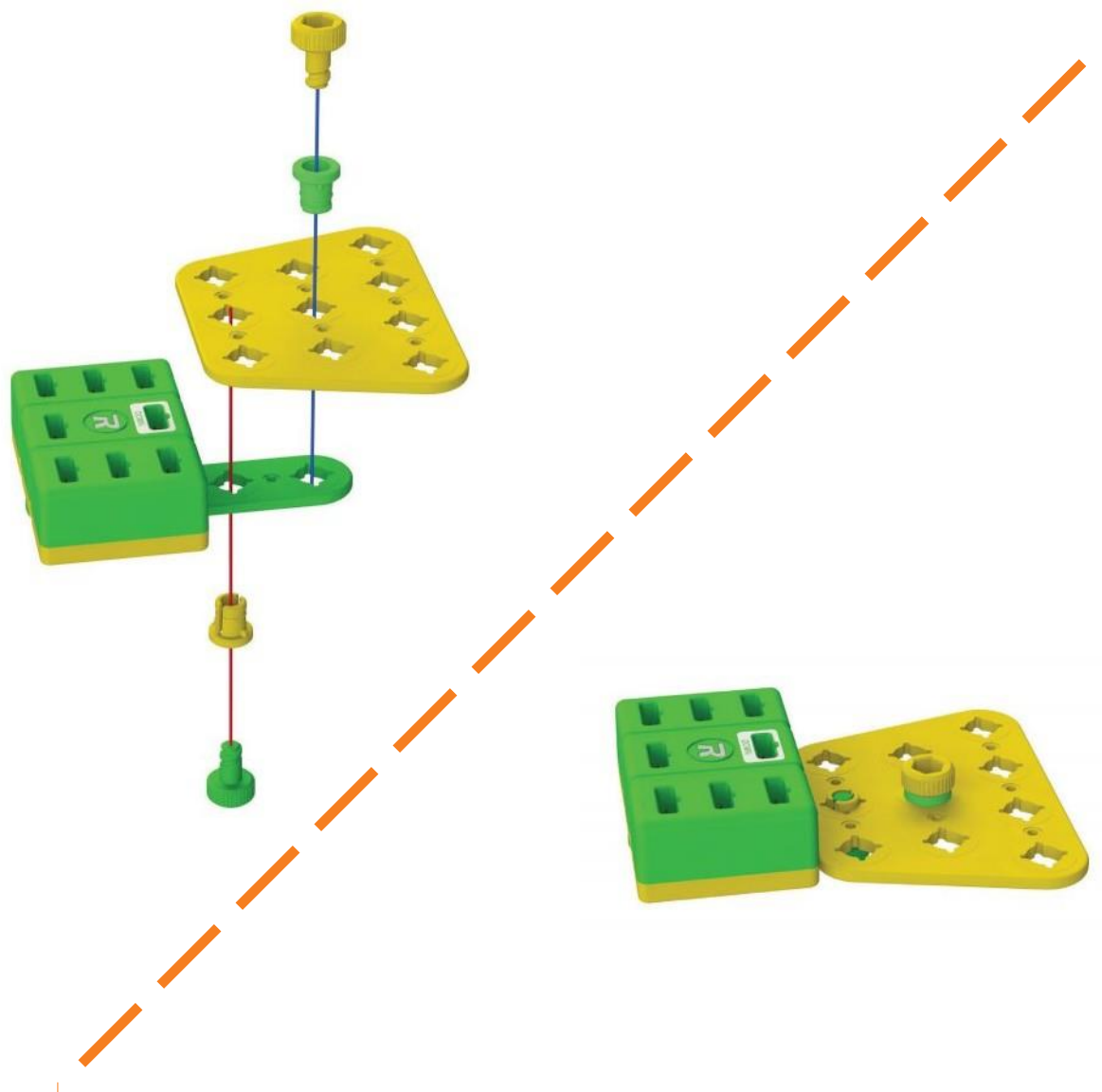
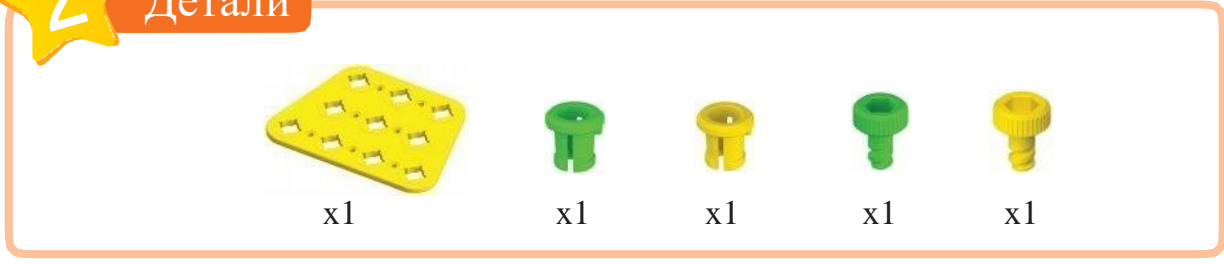

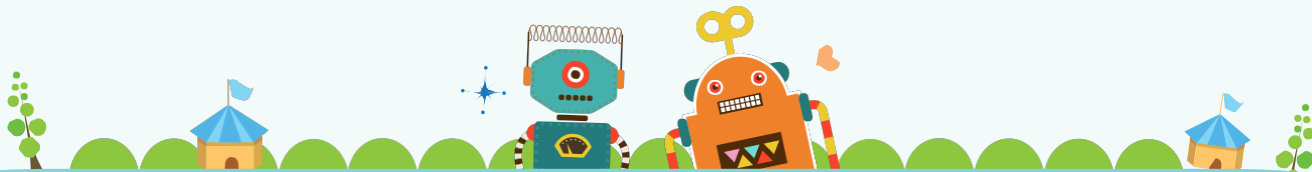

3

Детали



x2



x2



x2

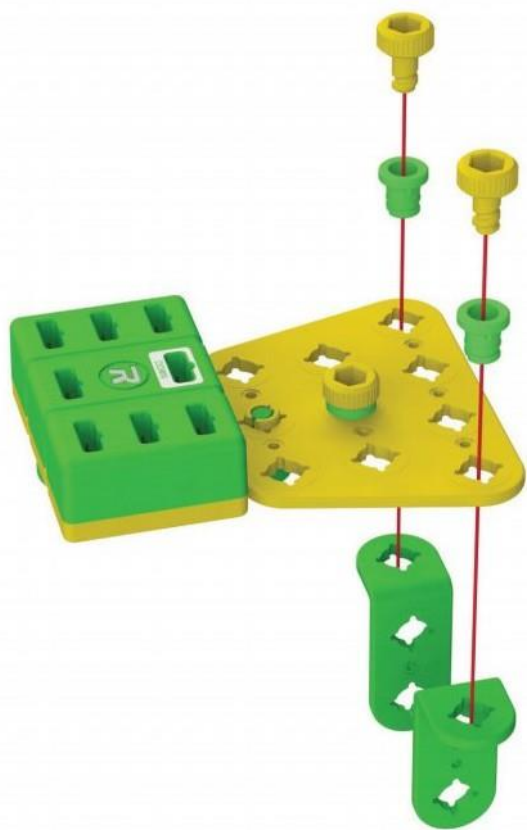

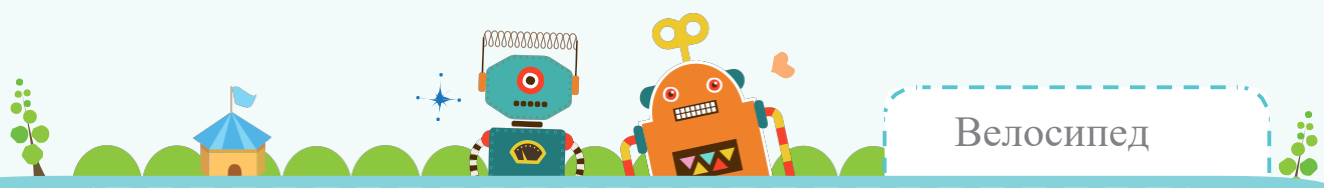

4

Детали



x2



x2



x2



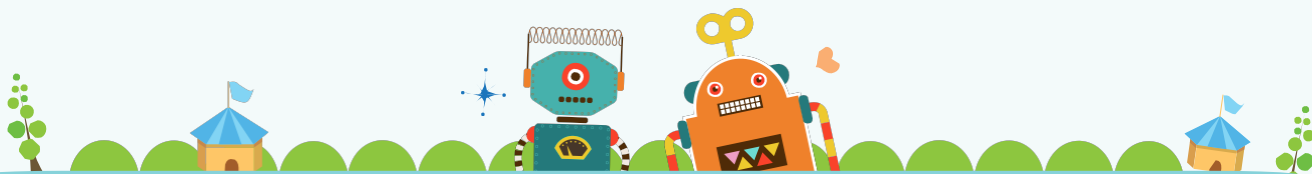

5

Детали



x2



x2



x2

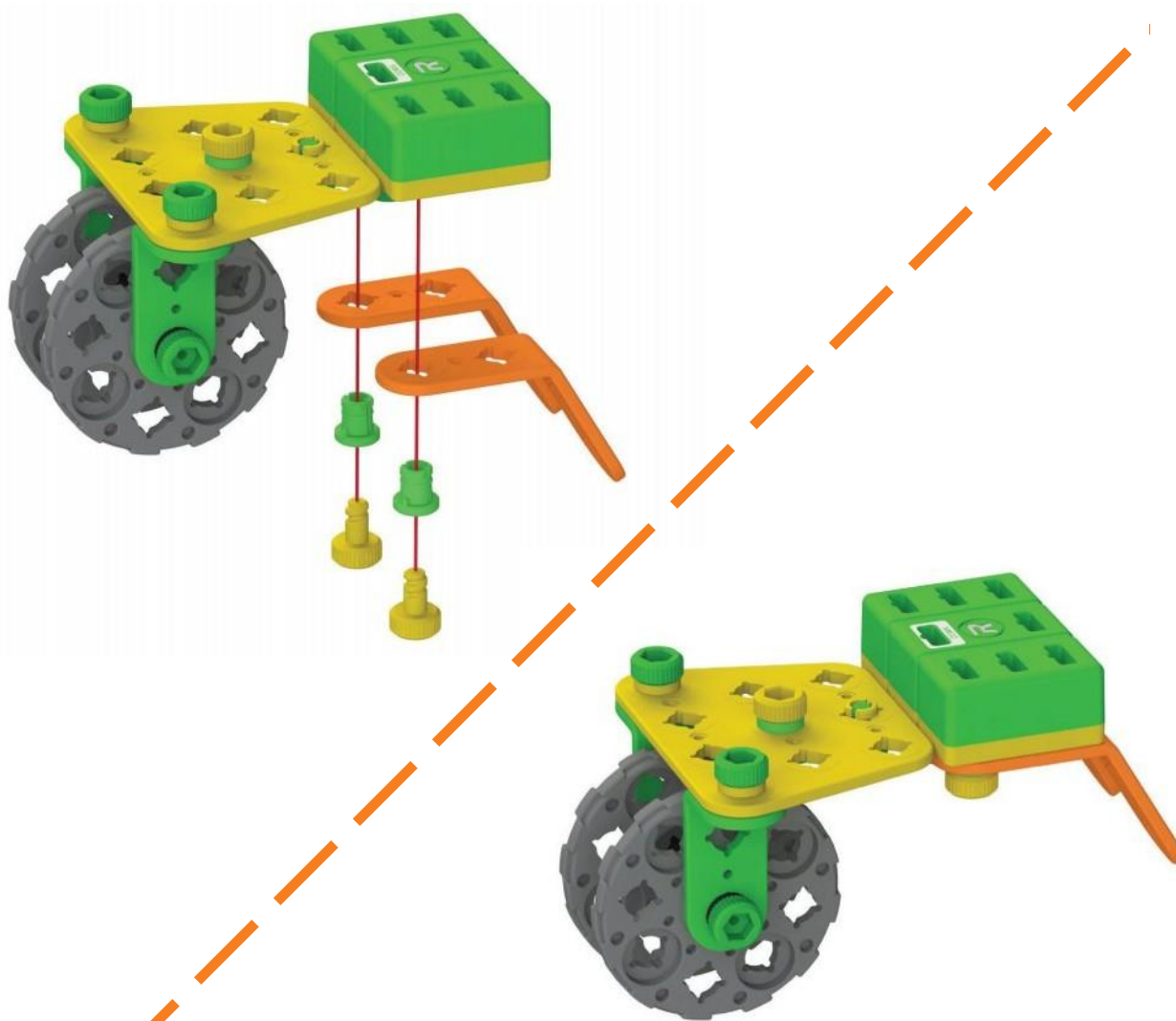

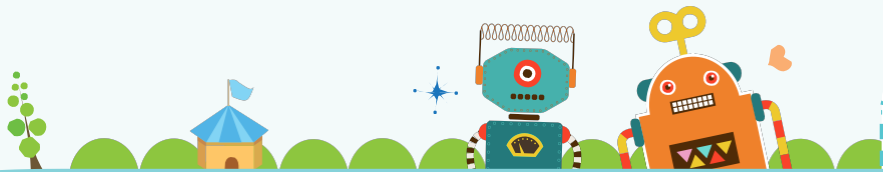

6

Детали



x1



x2



x2

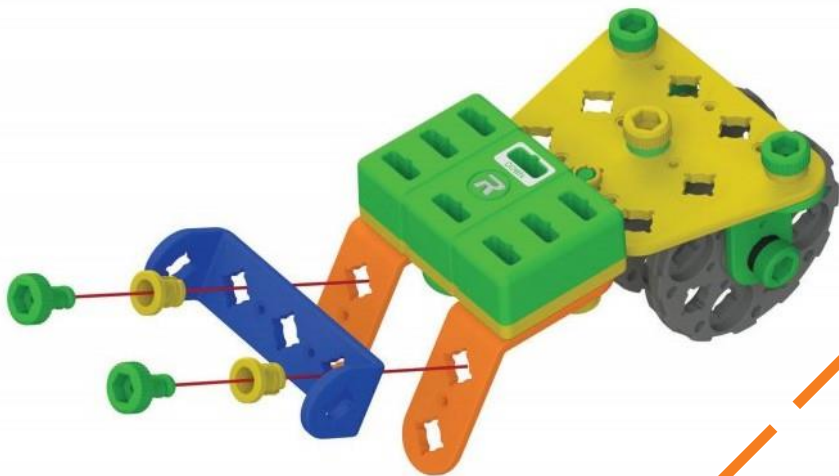

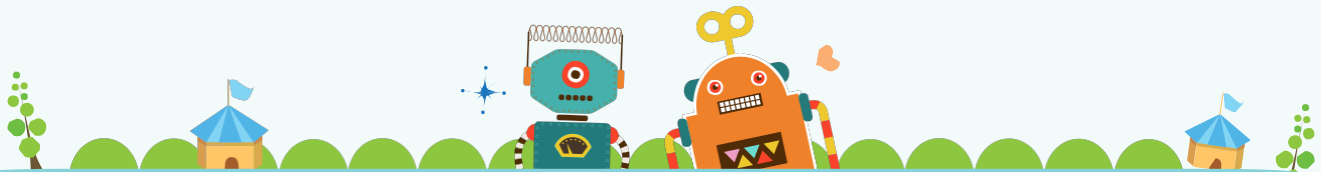

Детали



x1



x2



x2

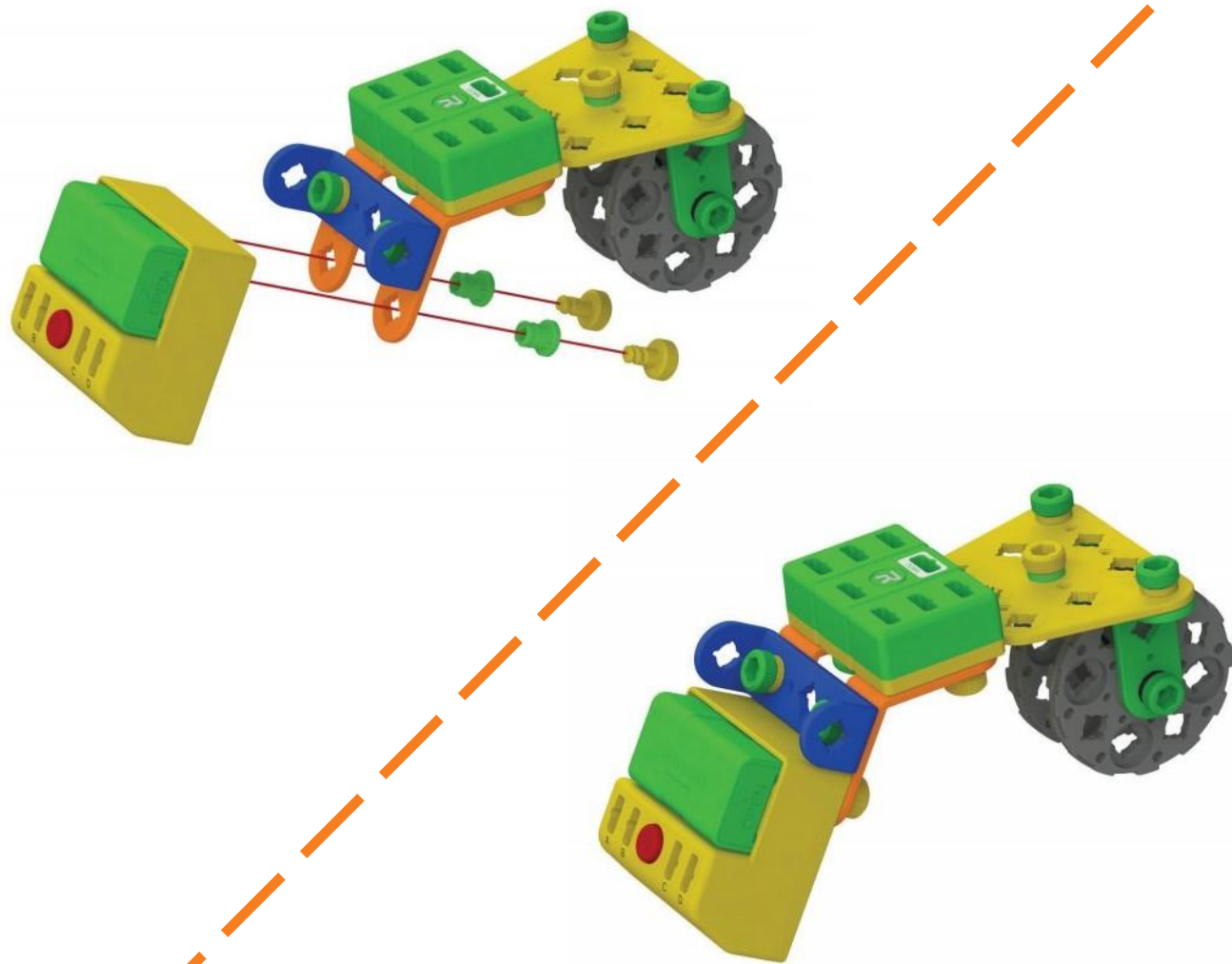



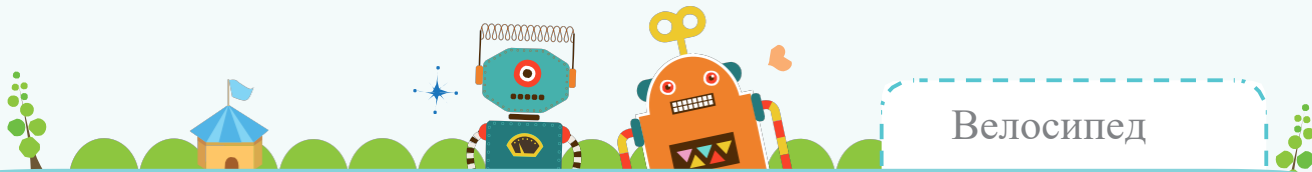

8

Детали



x1



x2



x2

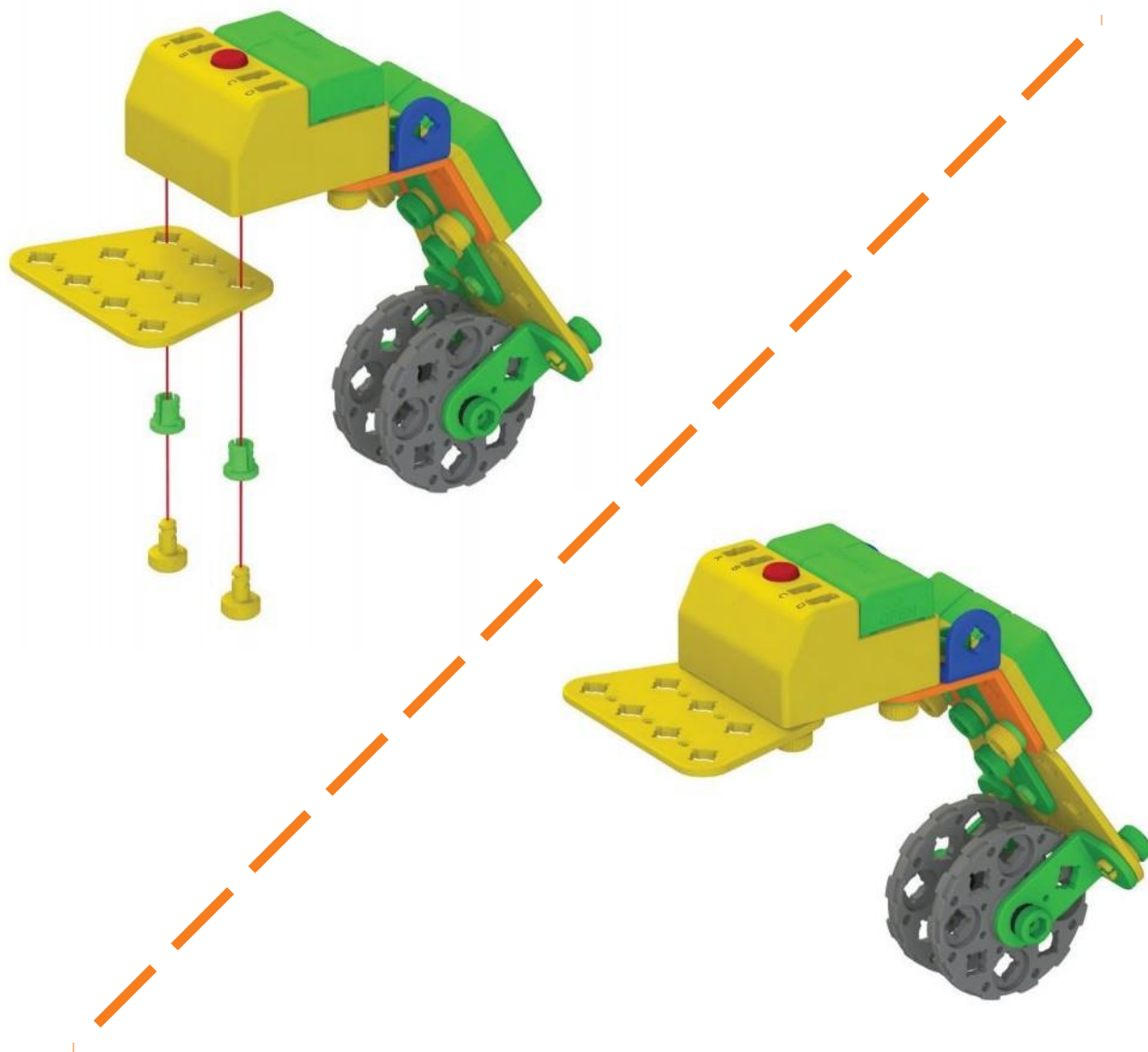

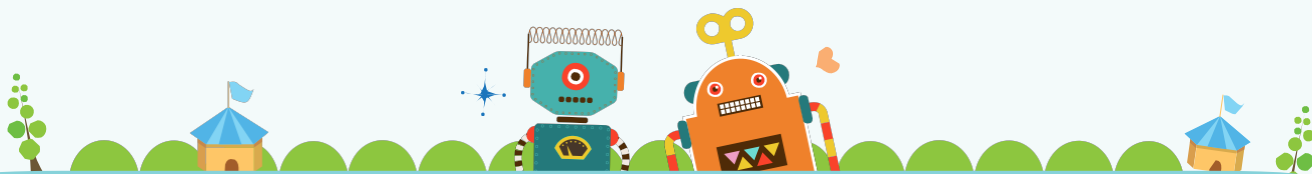

9

Детали



x2



x4



x4

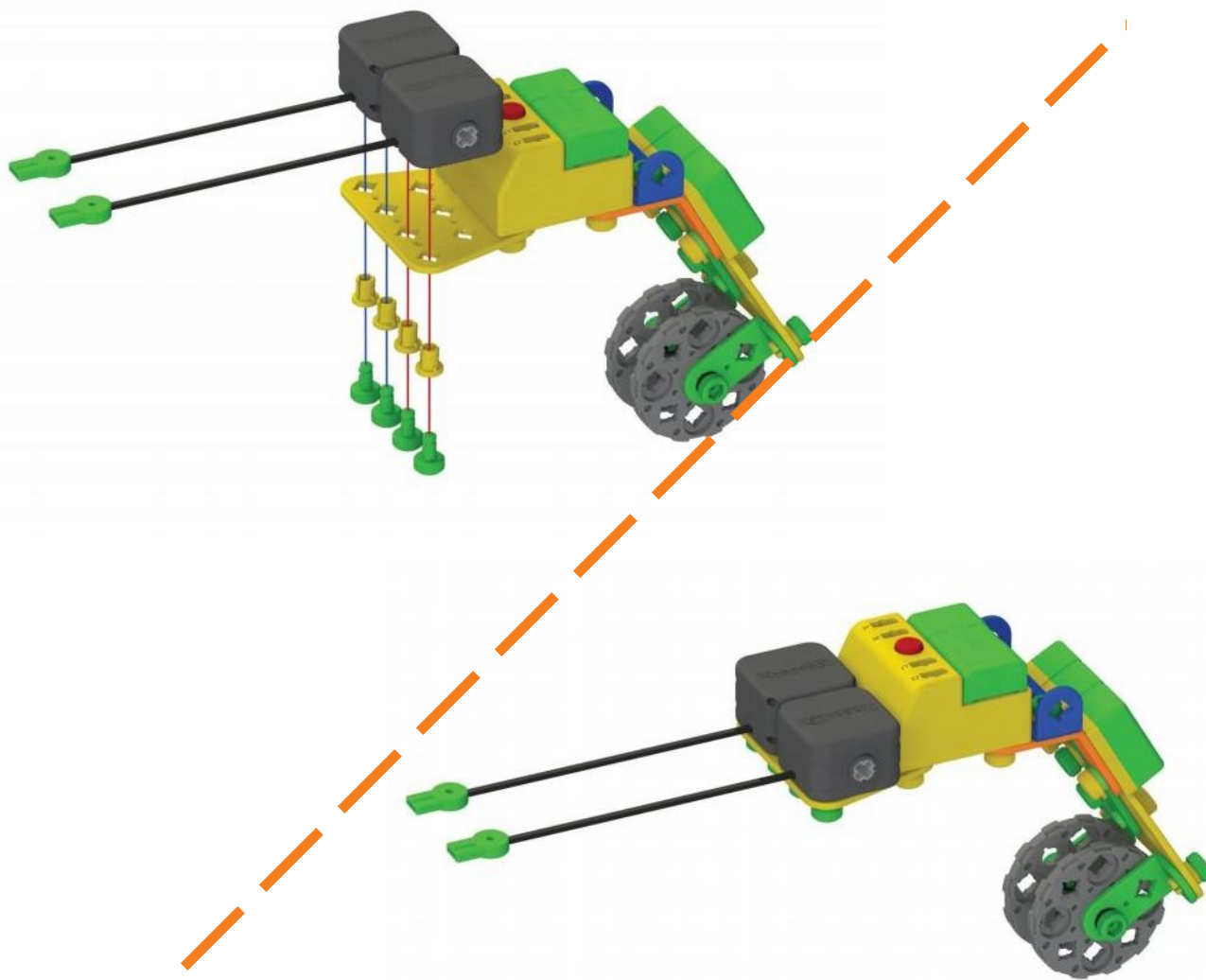

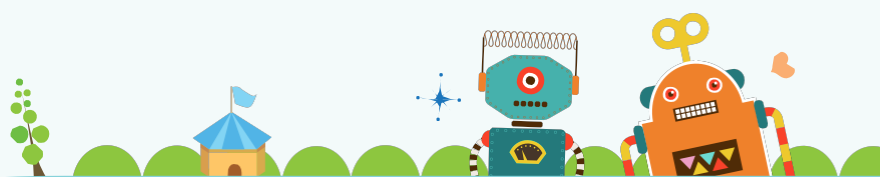

10

Детали



x2



x2



x2

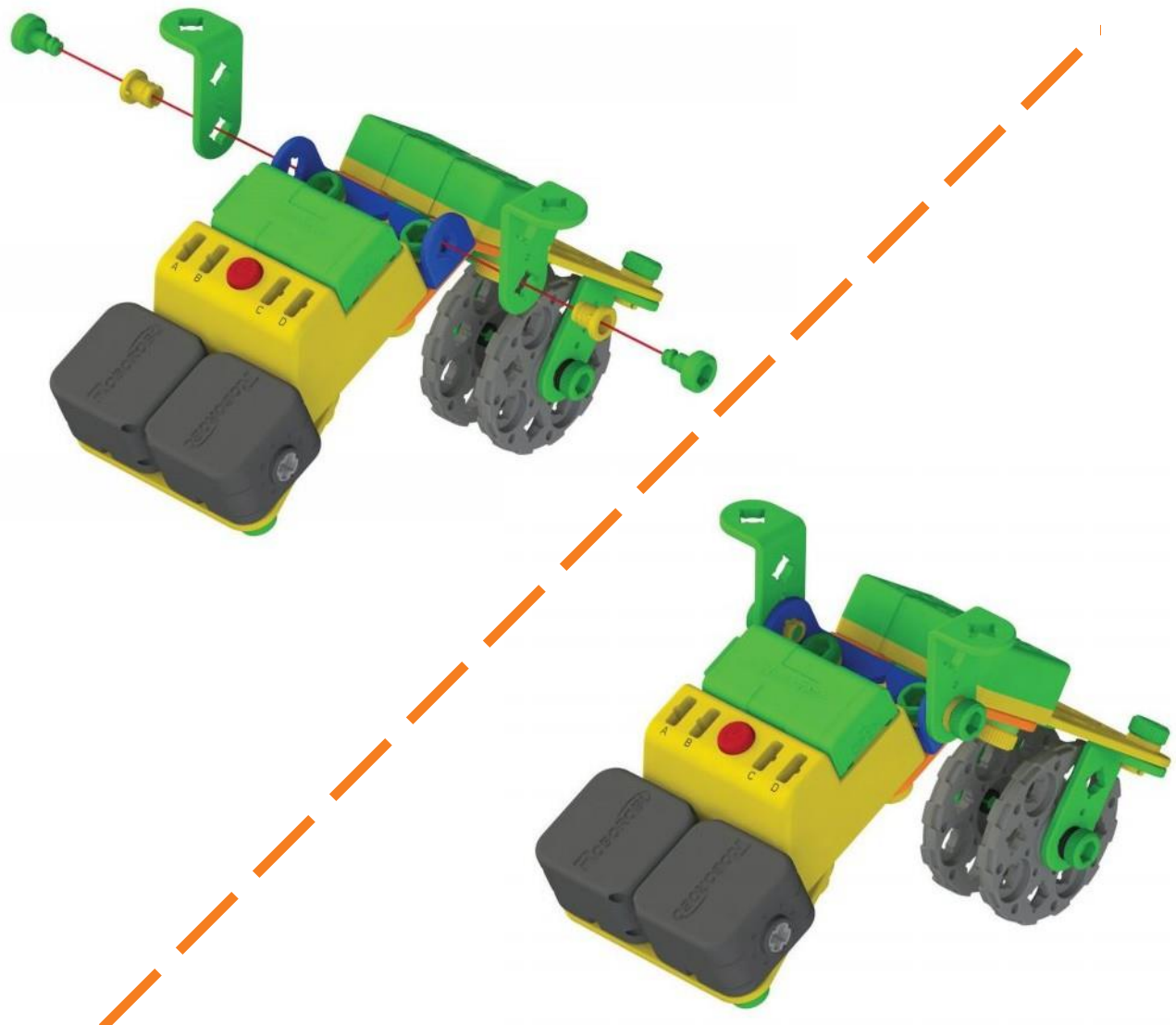

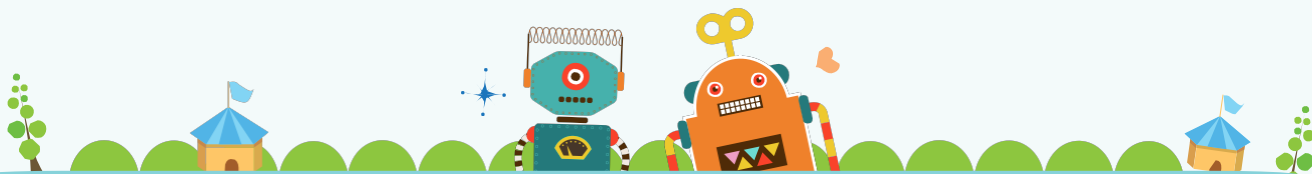

Детали



x2

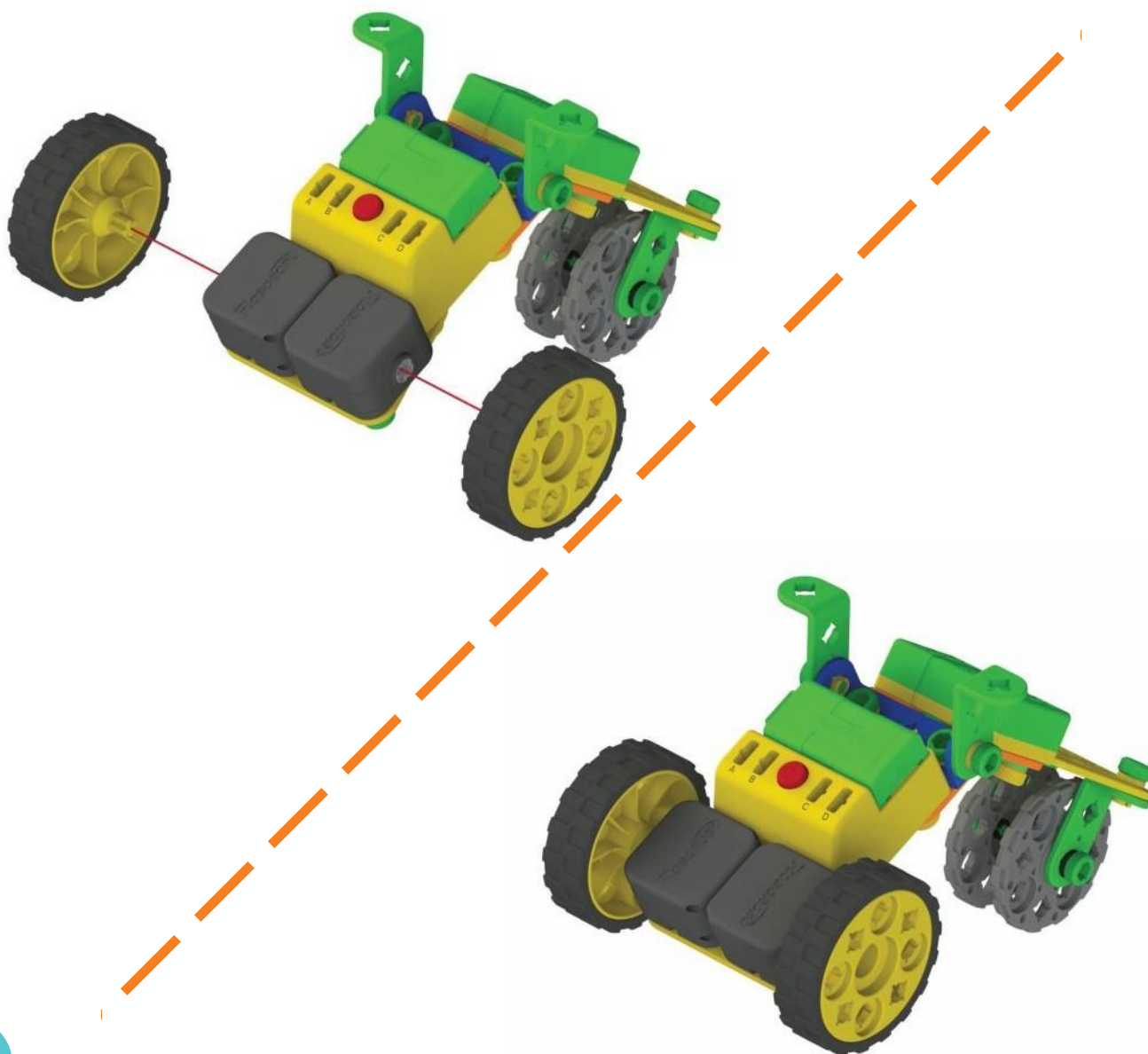

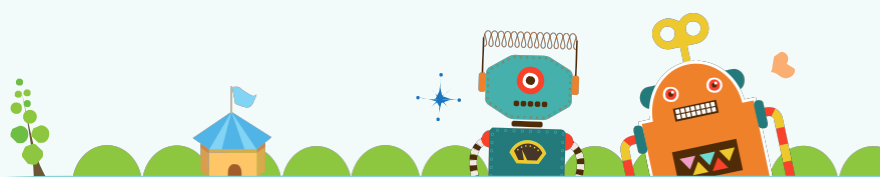

12 Детали



x1



x1

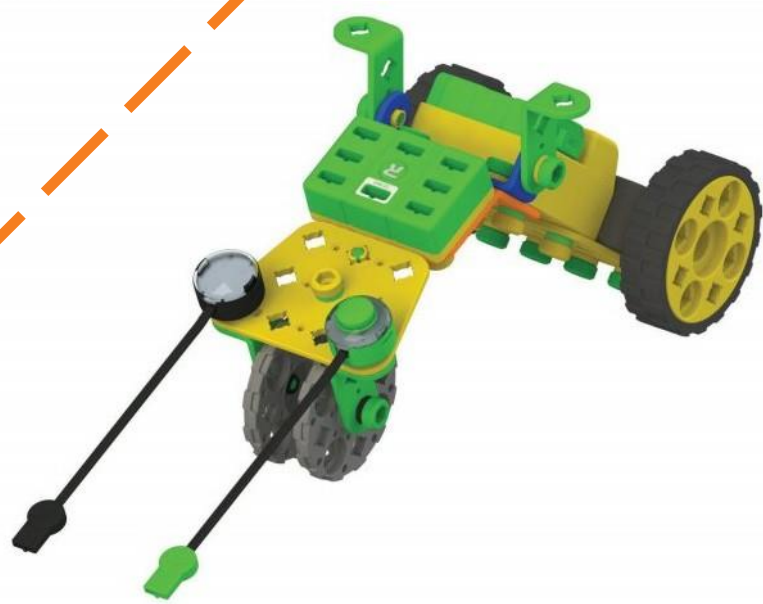

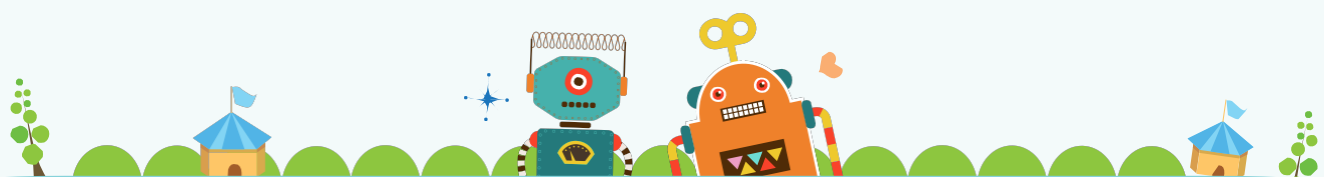

Двухсторонний кабель  
Подключите к порту D и ЦП

Правый электромотор  
Подключите к B

Левый электромотор  
Подключите к A

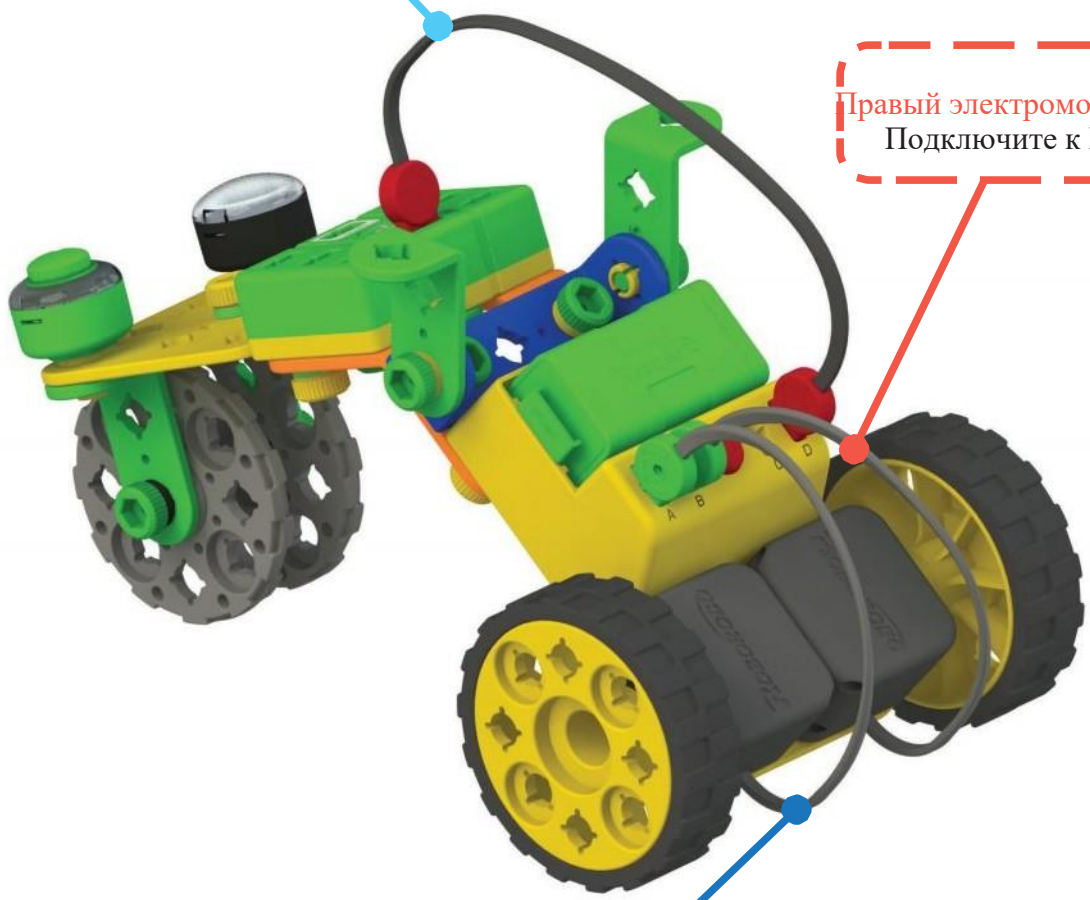



Плата дистанционного  
приемника  
Подключите к ЦП

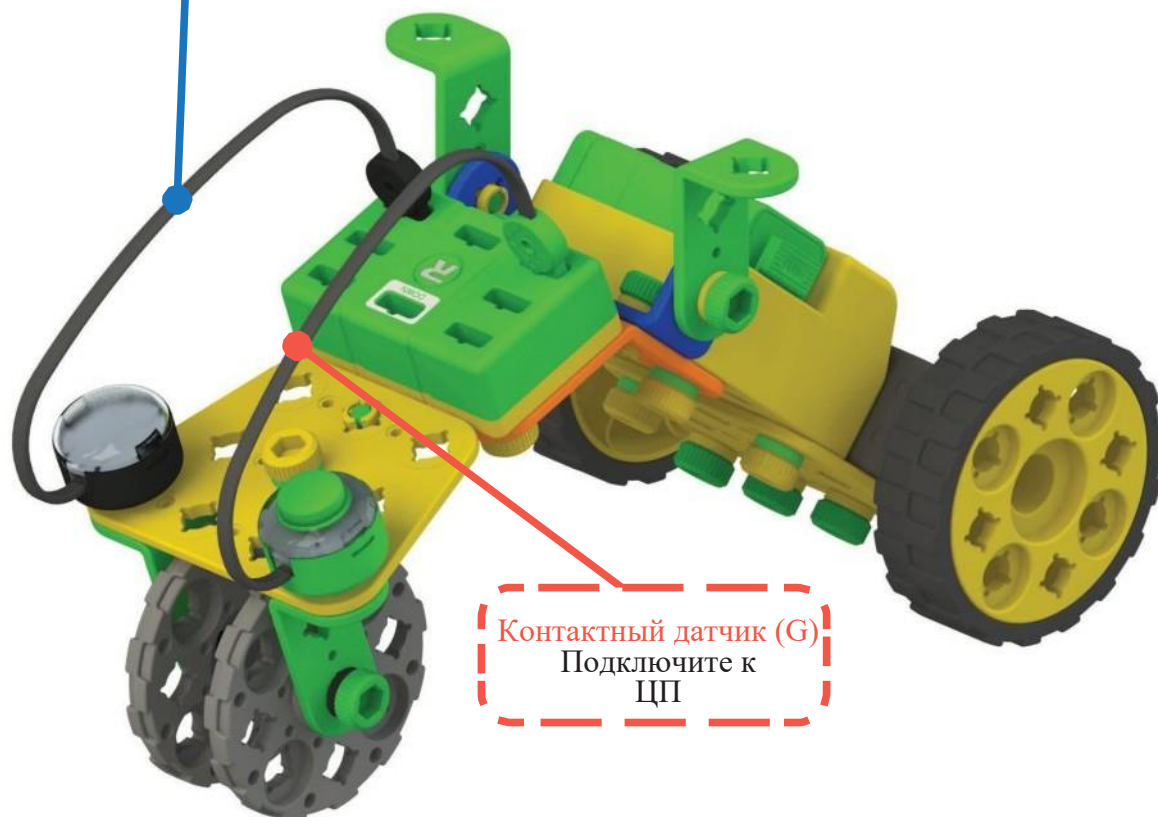

Контактный датчик (G)  
Подключите к  
ЦП



Запрограммируем движение велосипеда на программной плате.

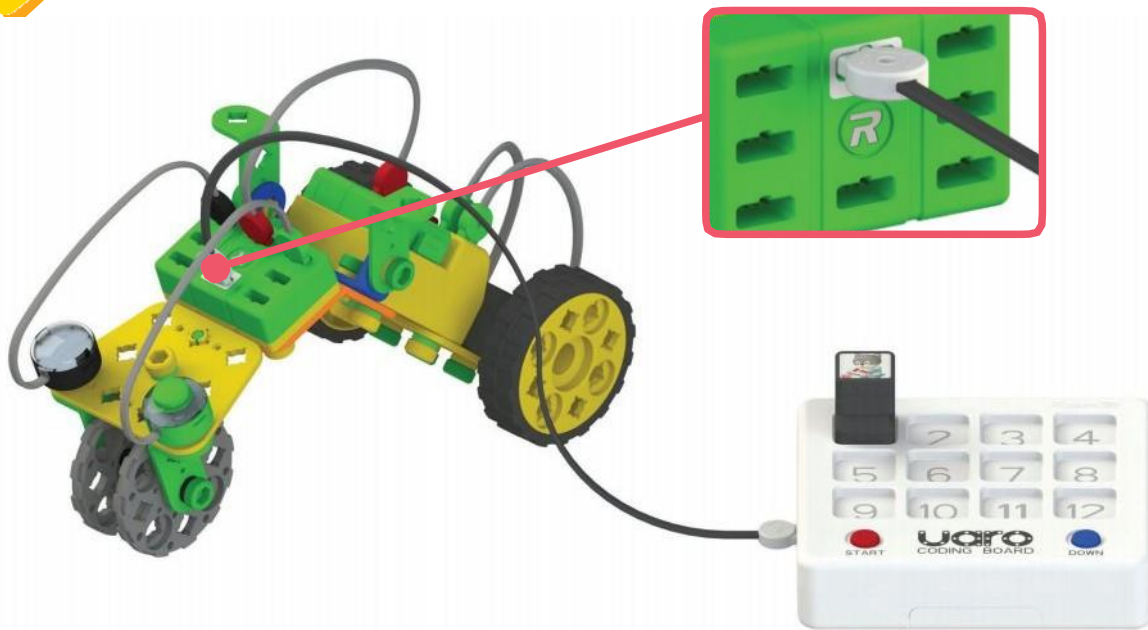

Управляйте велосипедом с помощью устройства дистанционного управления

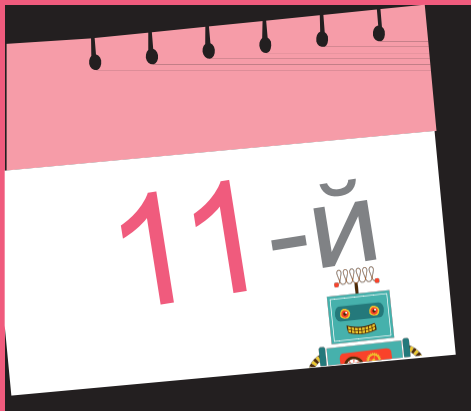

Сделаем вертолет!



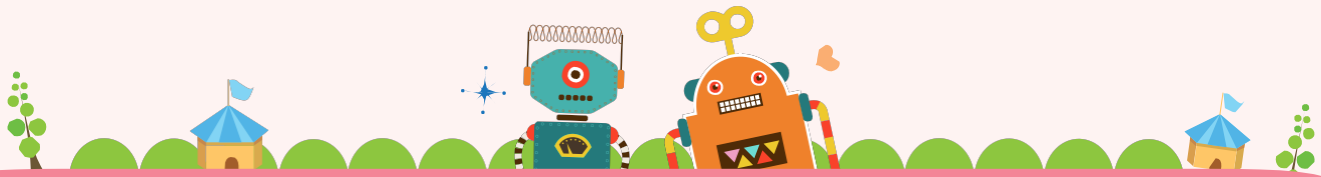

Детали



x1



x1



x2



x2

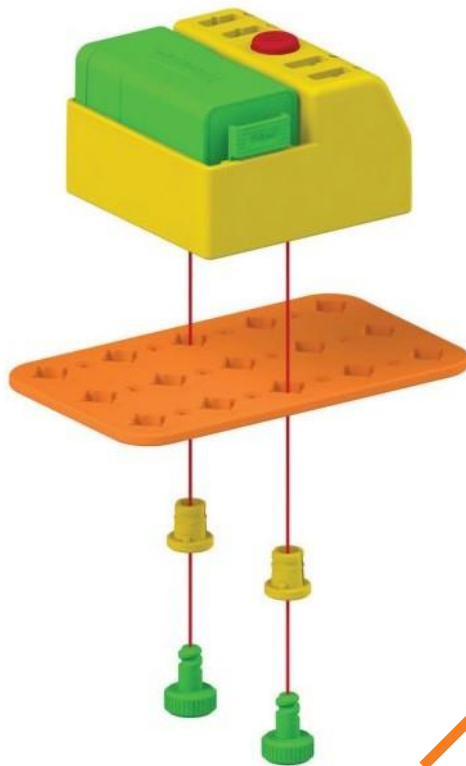

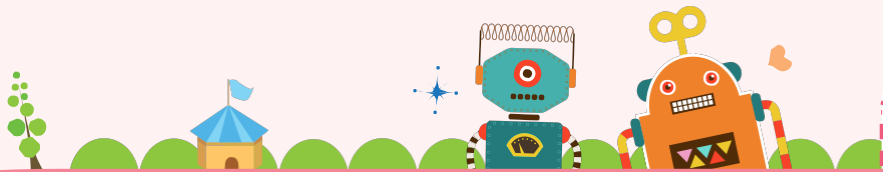

2

Детали



x1



x2



x2

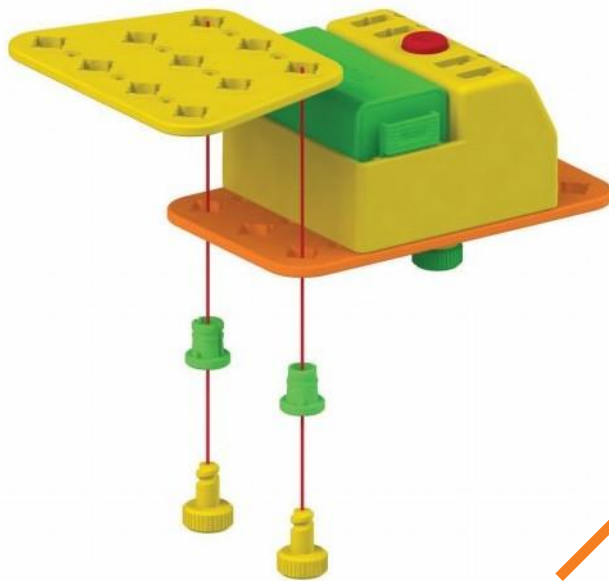

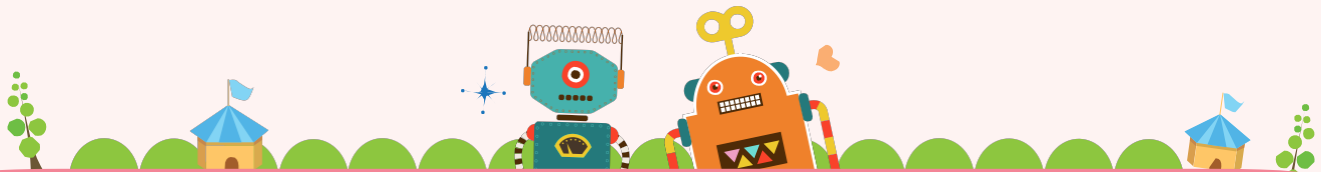

3

Детали



x1



x1



x2



x2

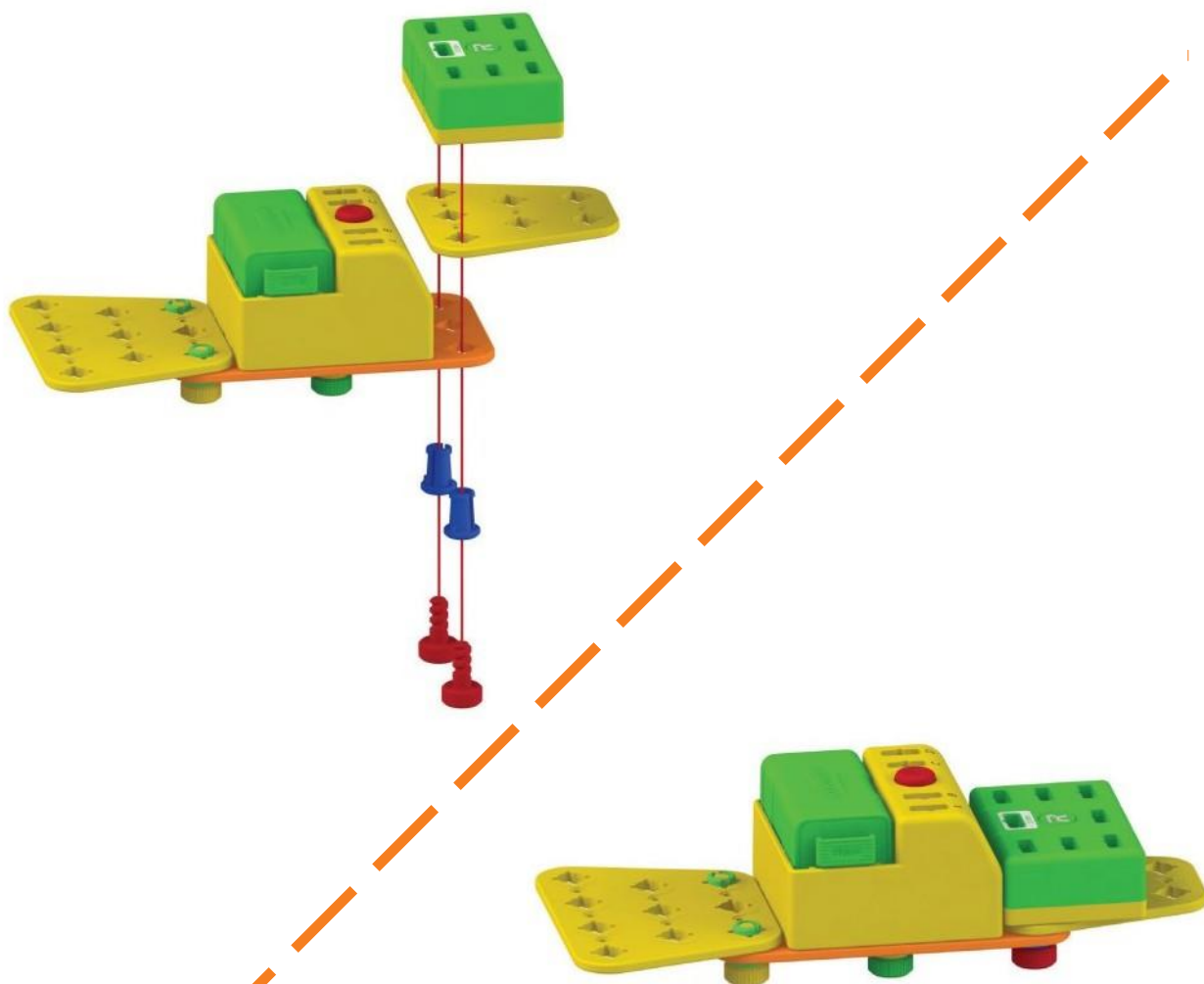



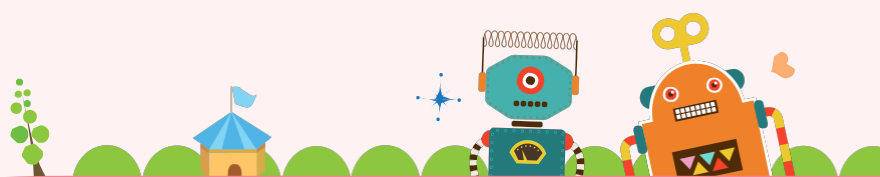

4

Детали



x1



x2



x2

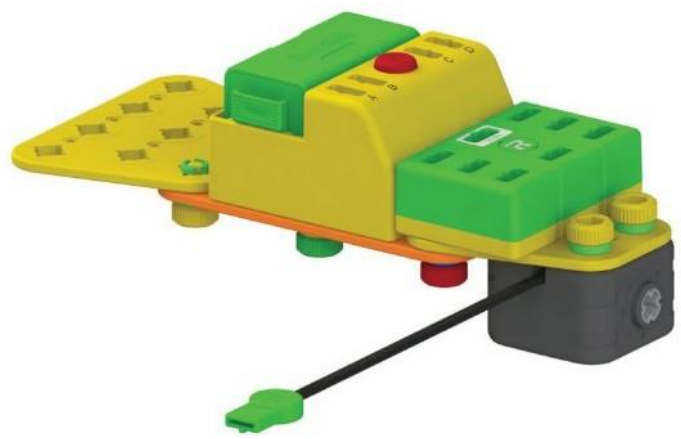
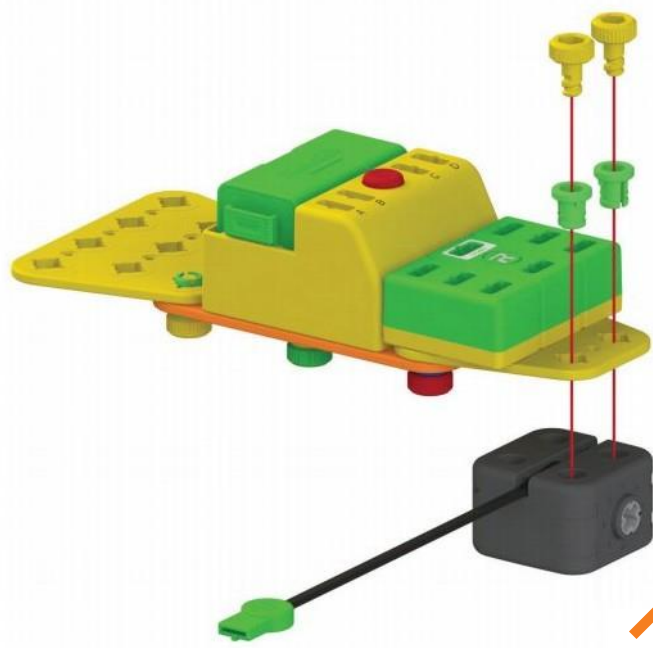

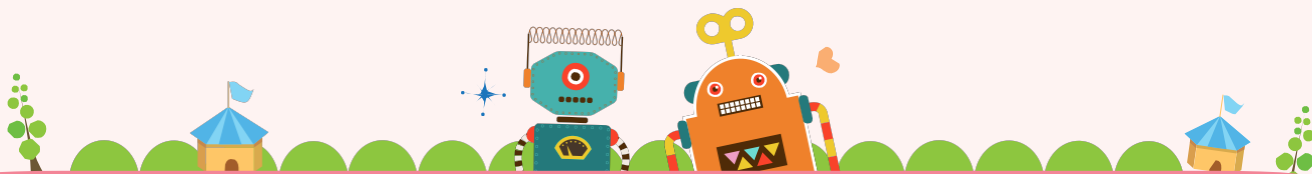

5

Детали



x1

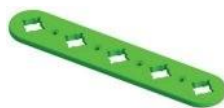

x1



x2



x2

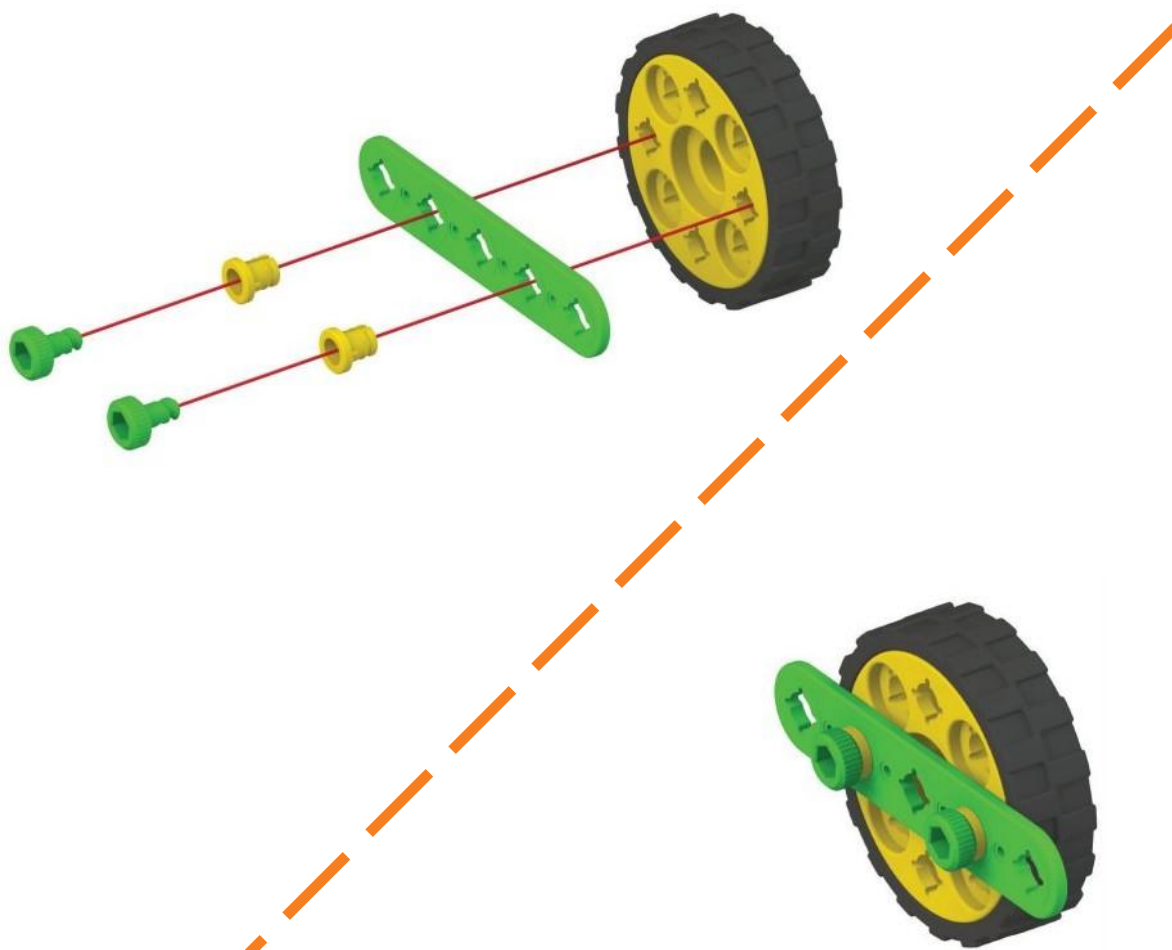

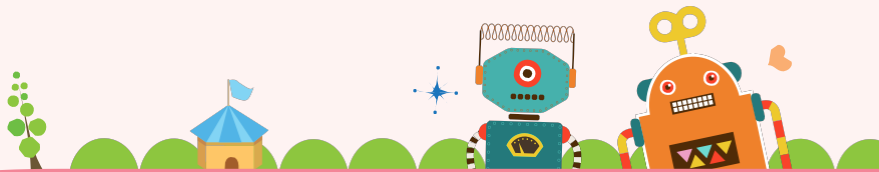

6

Детали

Продолжение Части 5

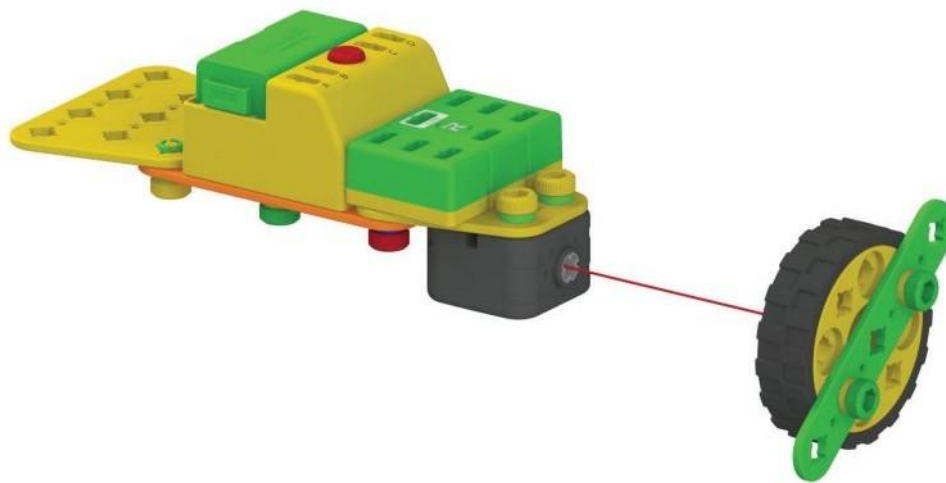

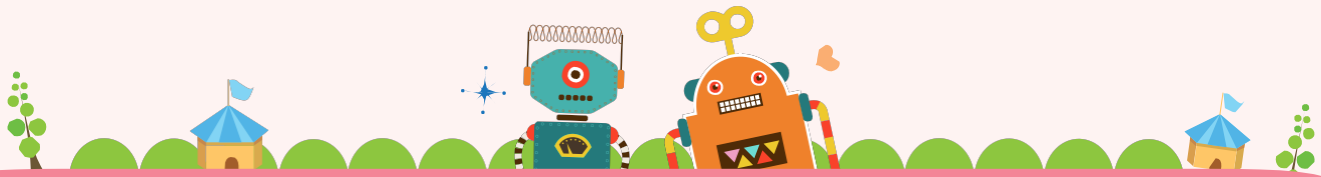

Детали



x1



x1



x2



x2

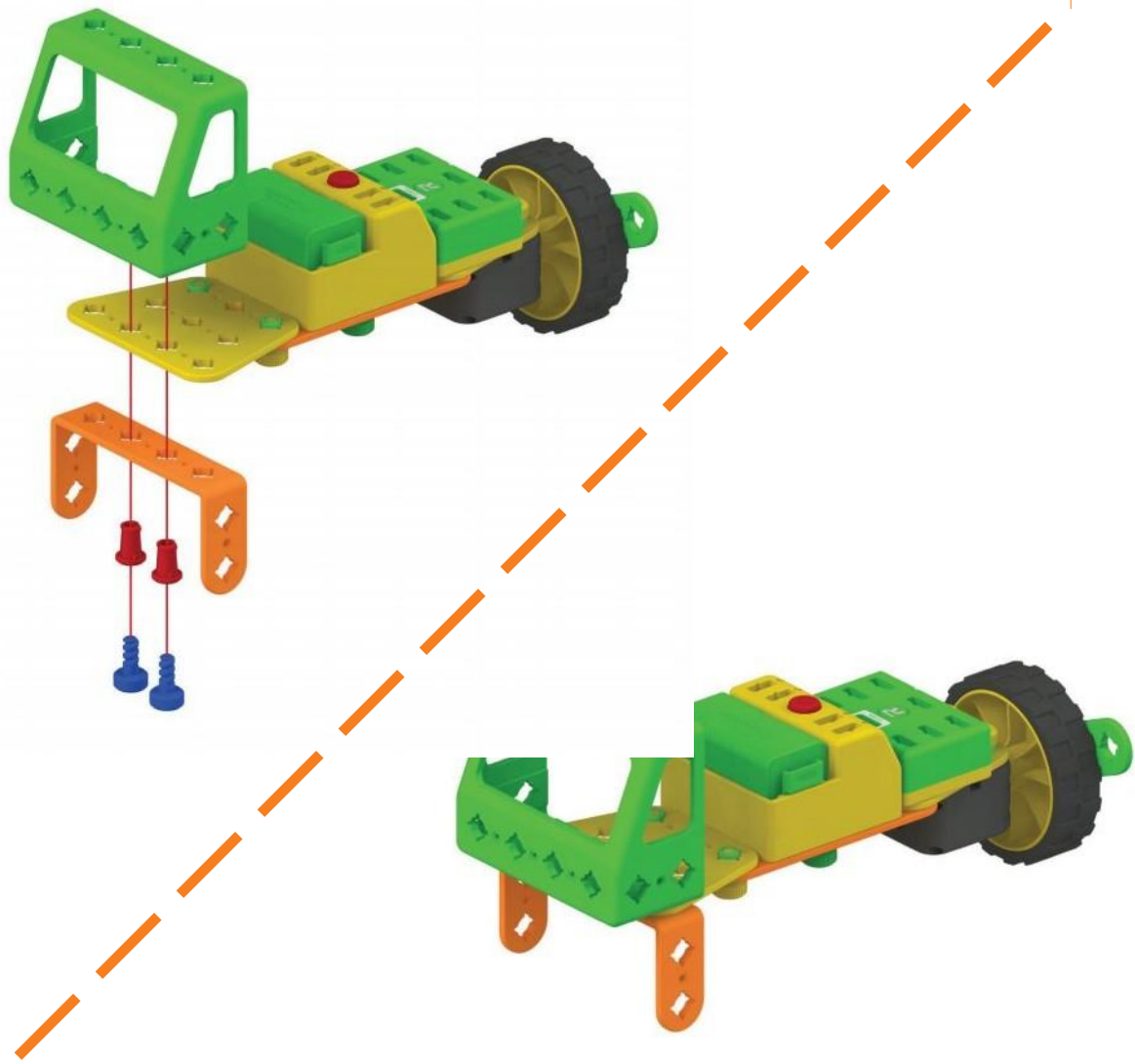

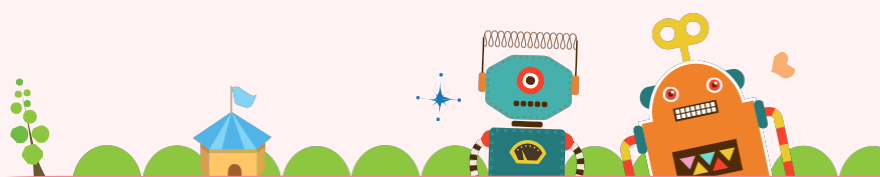

8 Детали

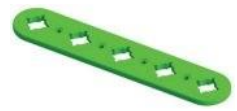

x2



x2



x2

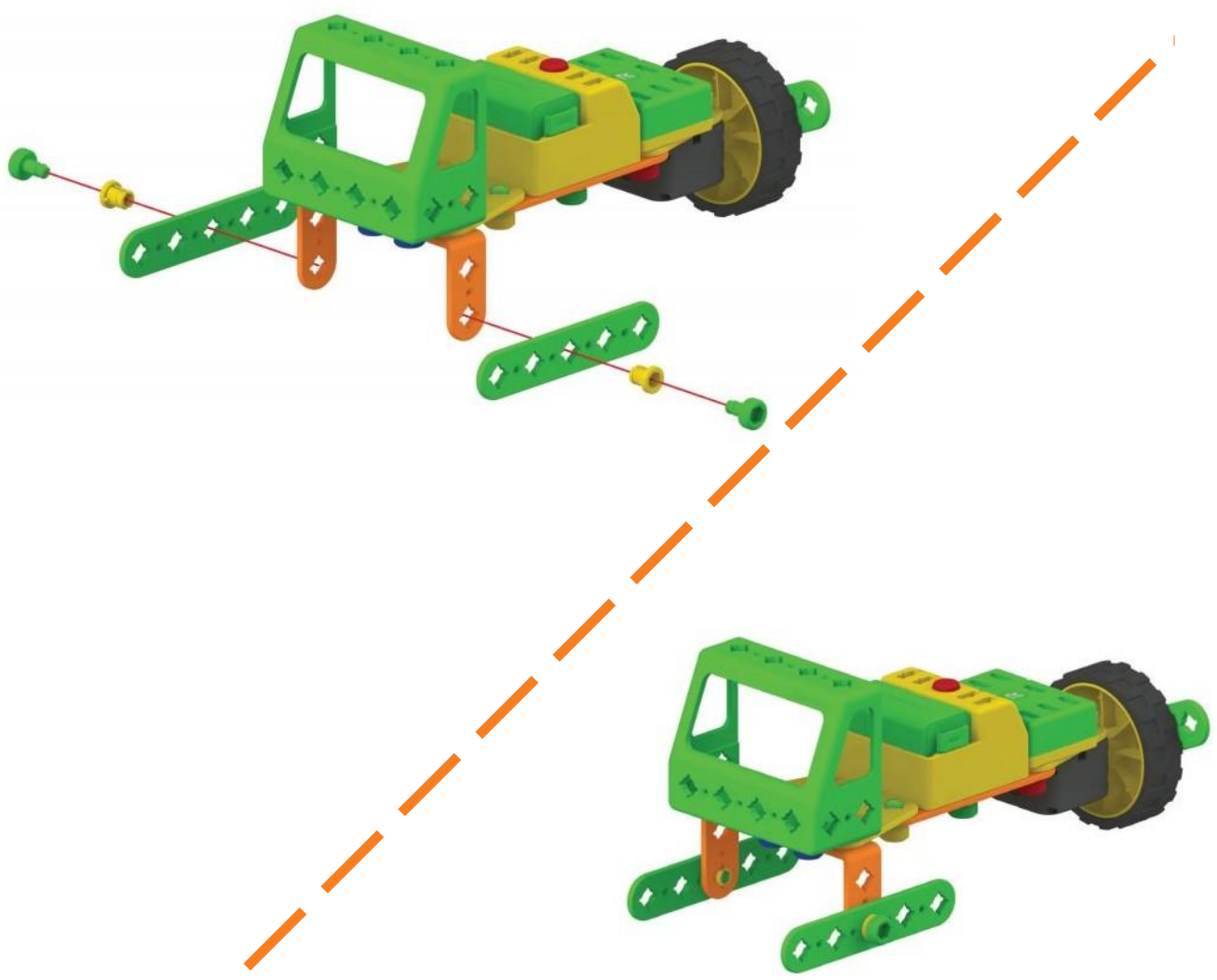

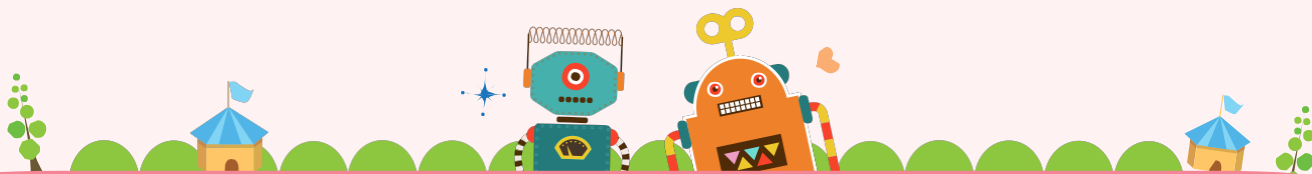

9

Детали



x1



x2



x2

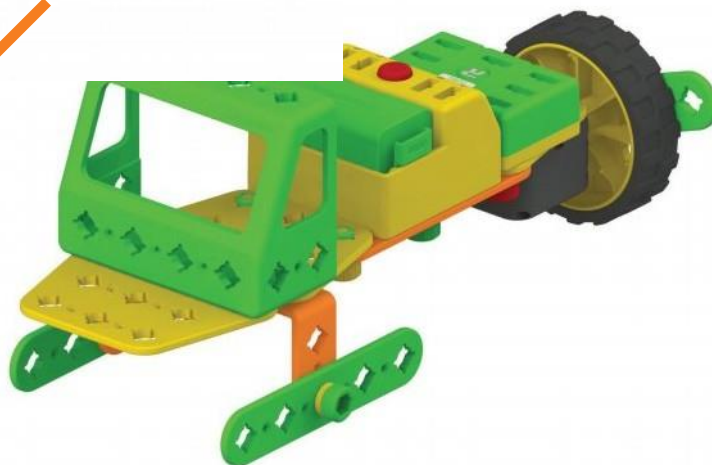
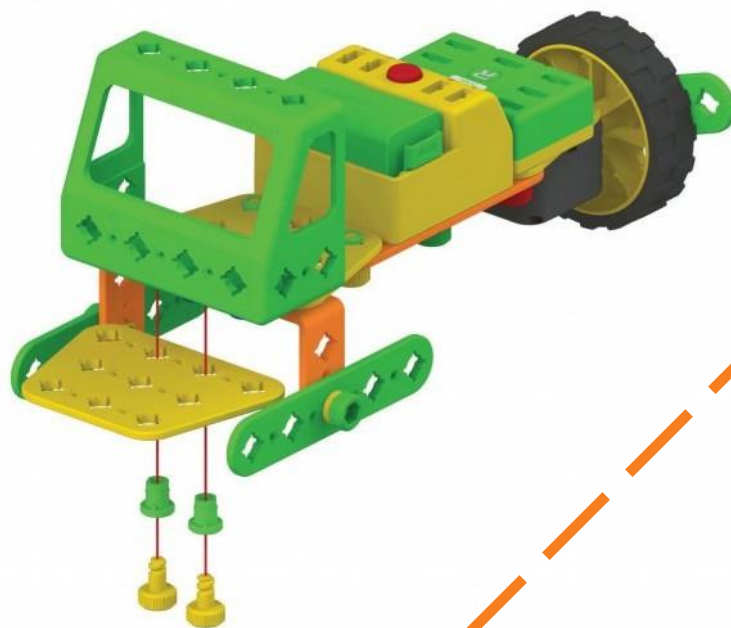



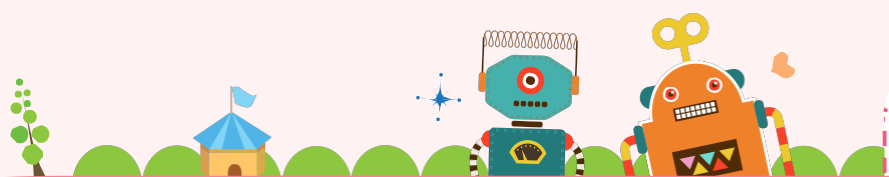

10

Детали



x1



x2



x2



x2

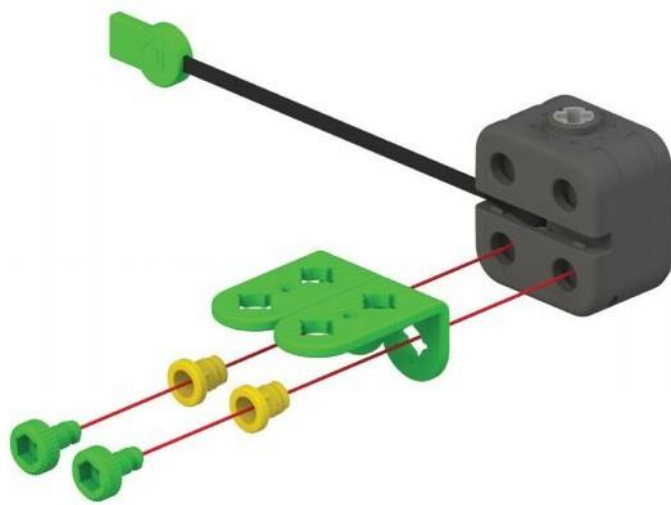

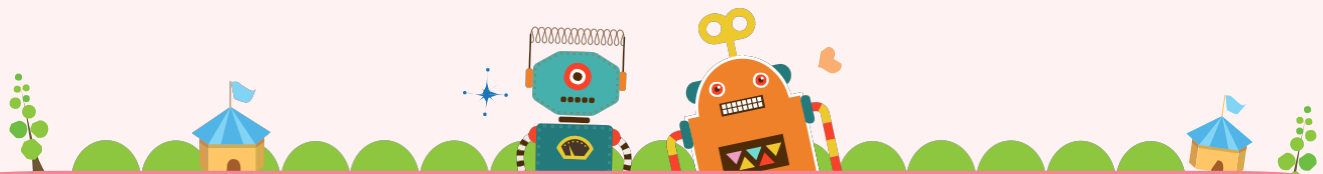

Детали



x1



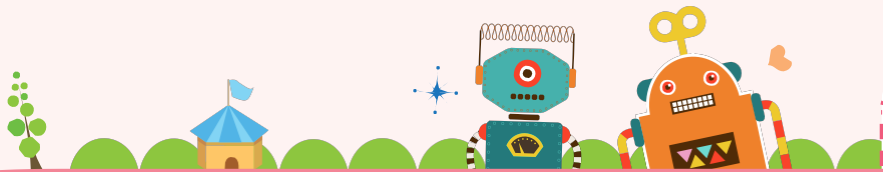

12

Детали



x4



x4



x4

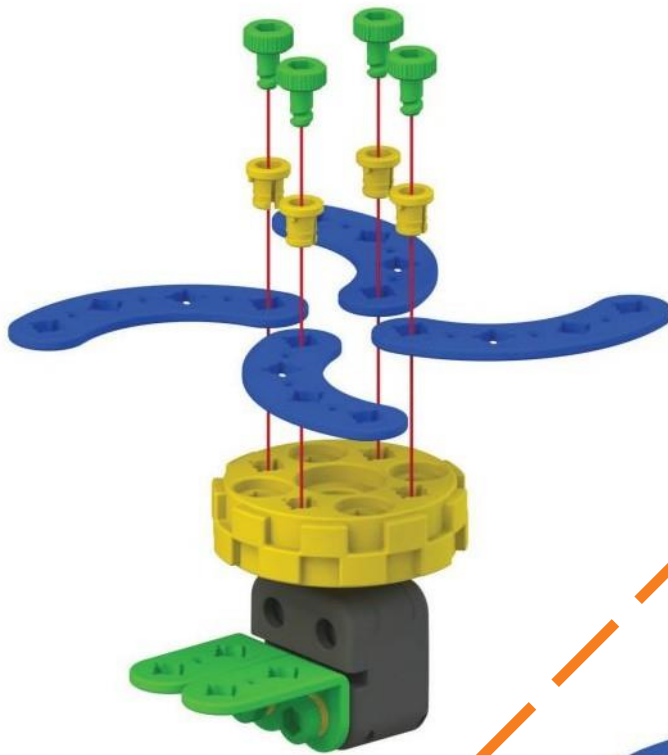

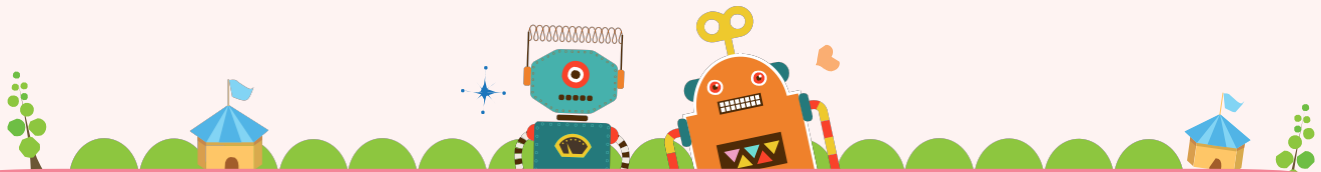

13

Детали



x2



x2



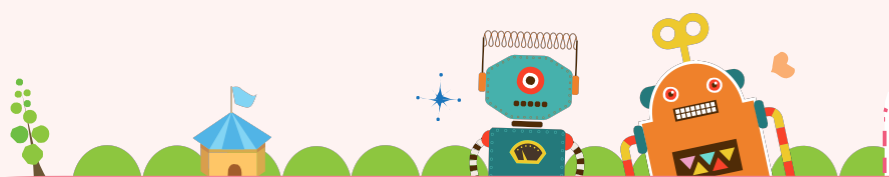

14 Детали



x2



x2



x1



x1



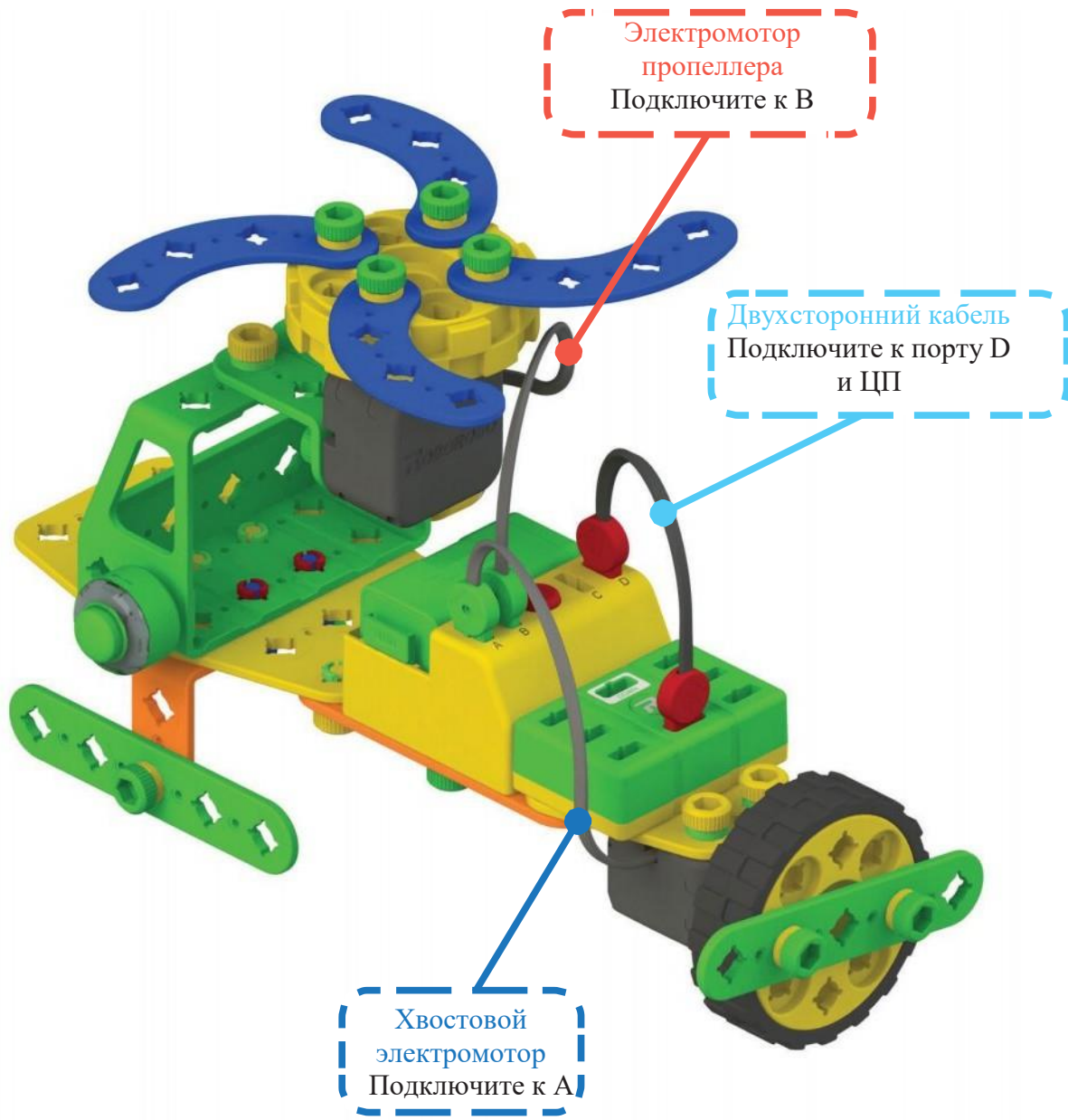
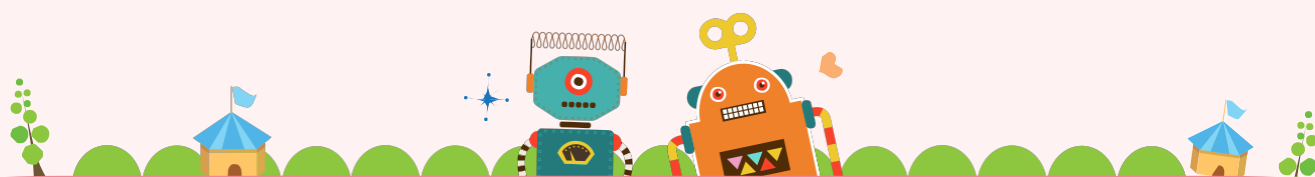



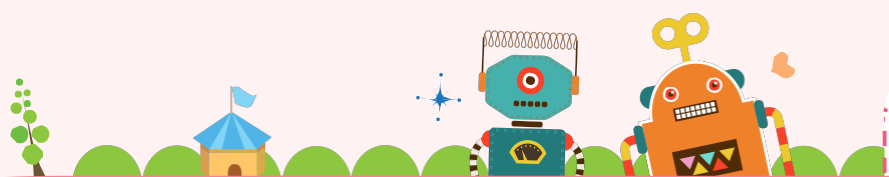

Вертолет

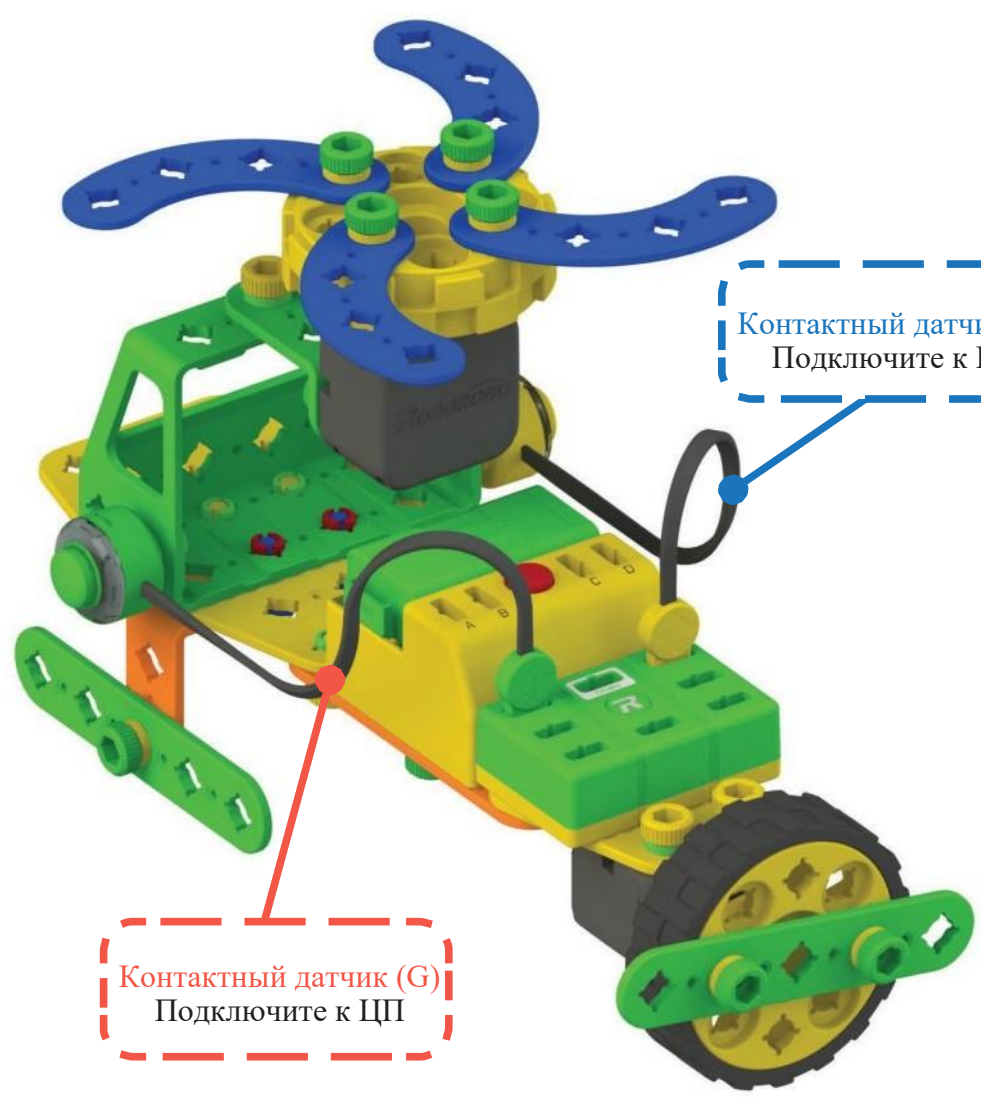

Контактный датчик (Y)  
Подключите к ЦП

Контактный датчик (G)  
Подключите к ЦП



Запрограммируем движение робота вертолета на программной плате.

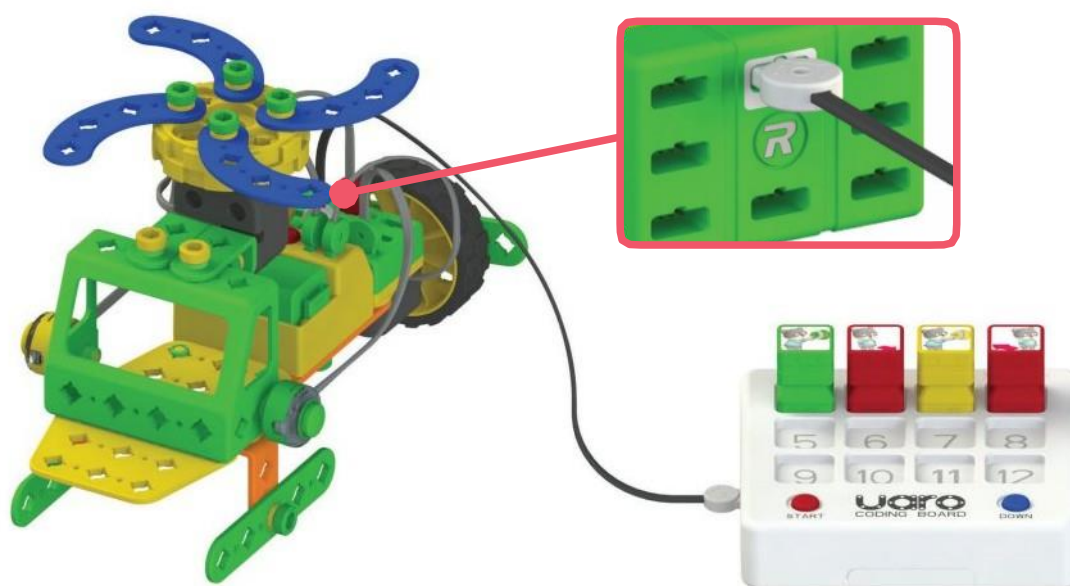

Если нажат зеленый контактный датчик, электромотор будет вращаться вправо. Если нажат желтый контактный датчик, электромотор будет вращаться влево.

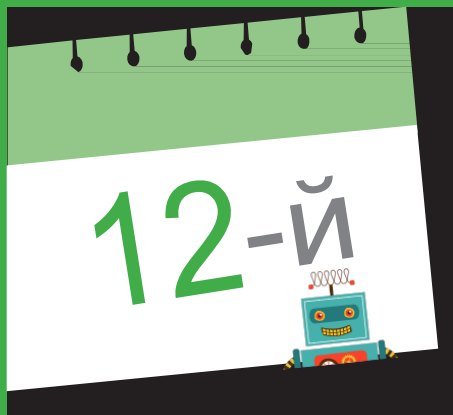

Прокатимся на поезде!



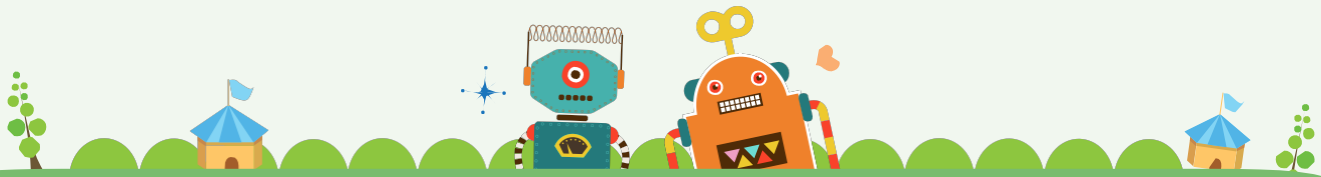

Детали



x1



x1



x2



x2



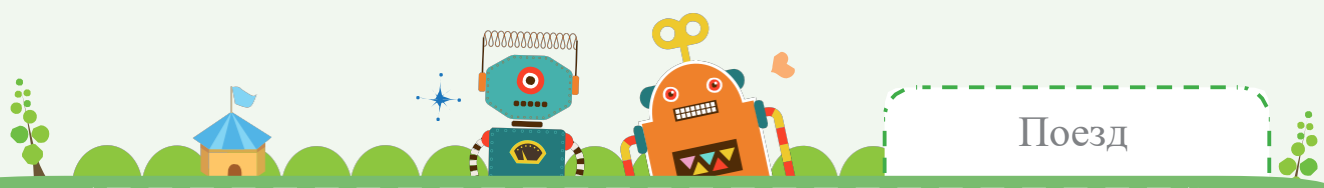

2 Детали

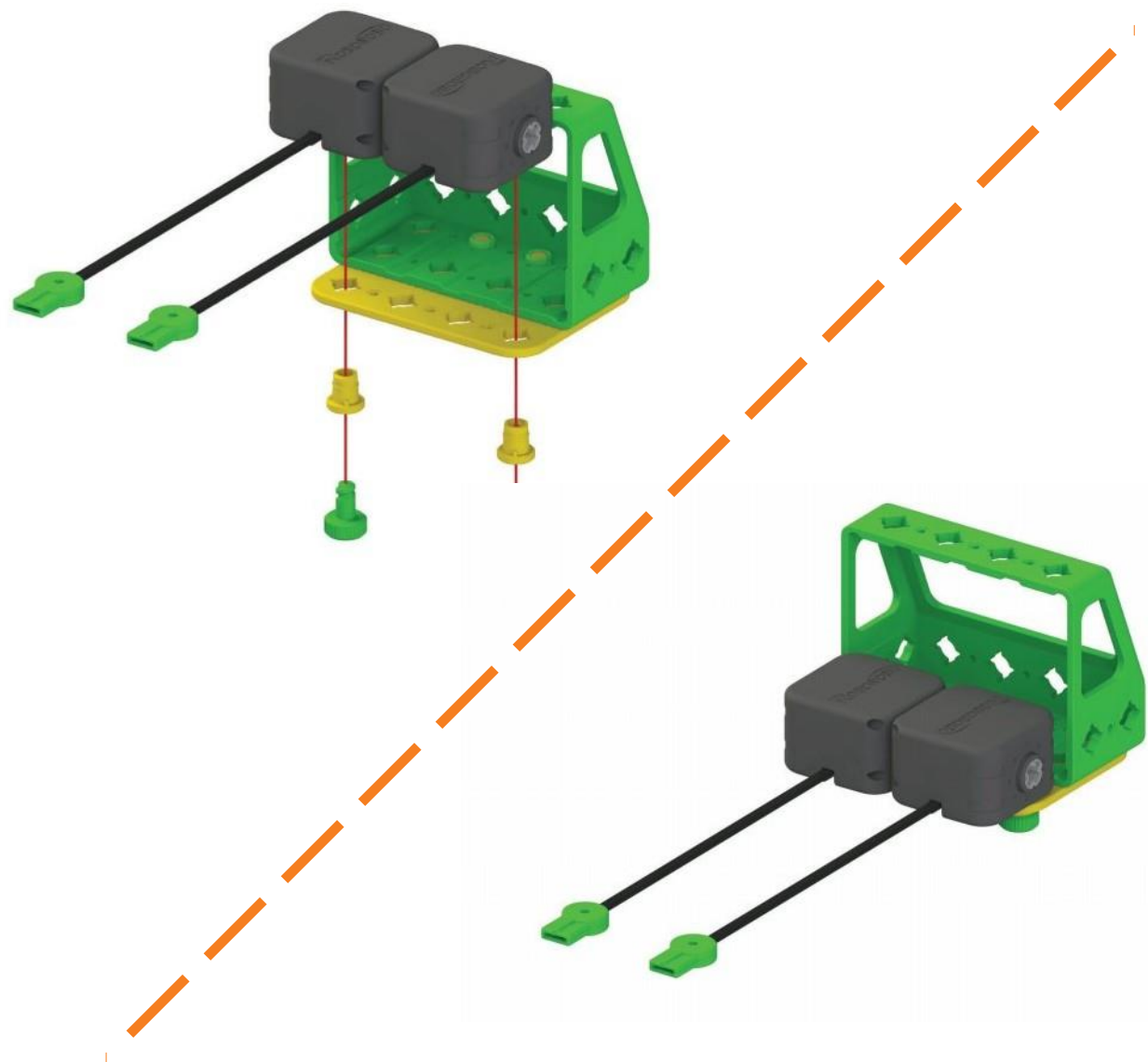

3

Детали



x1



x2



x2

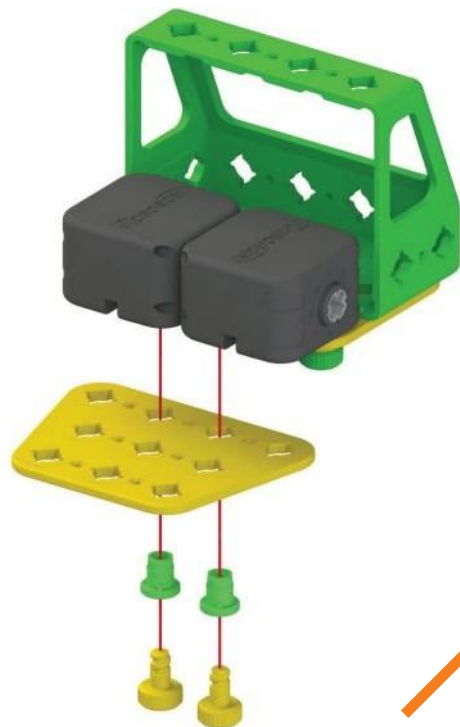





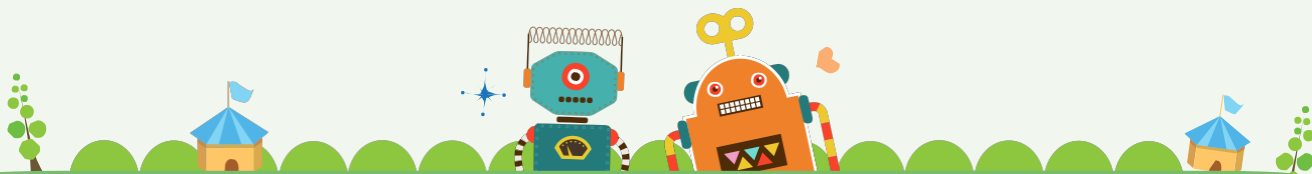

5

Детали



x1



x1



x2



x2

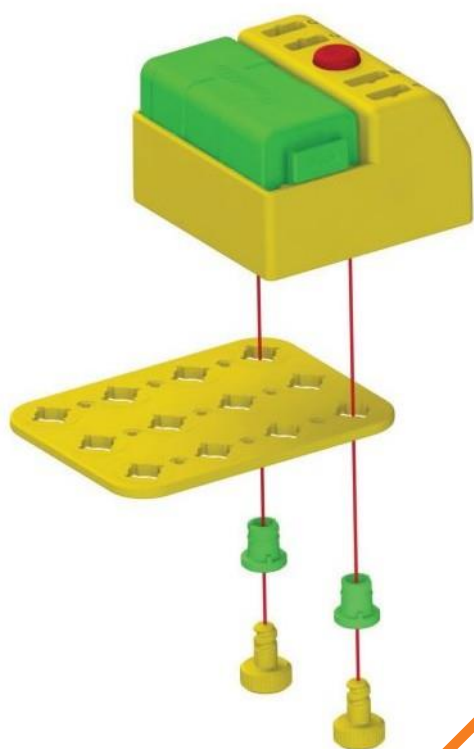

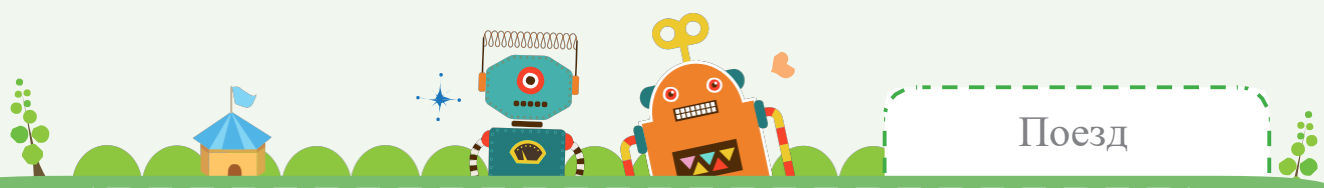

6 Детали



x1



x1



x1



x2



x1

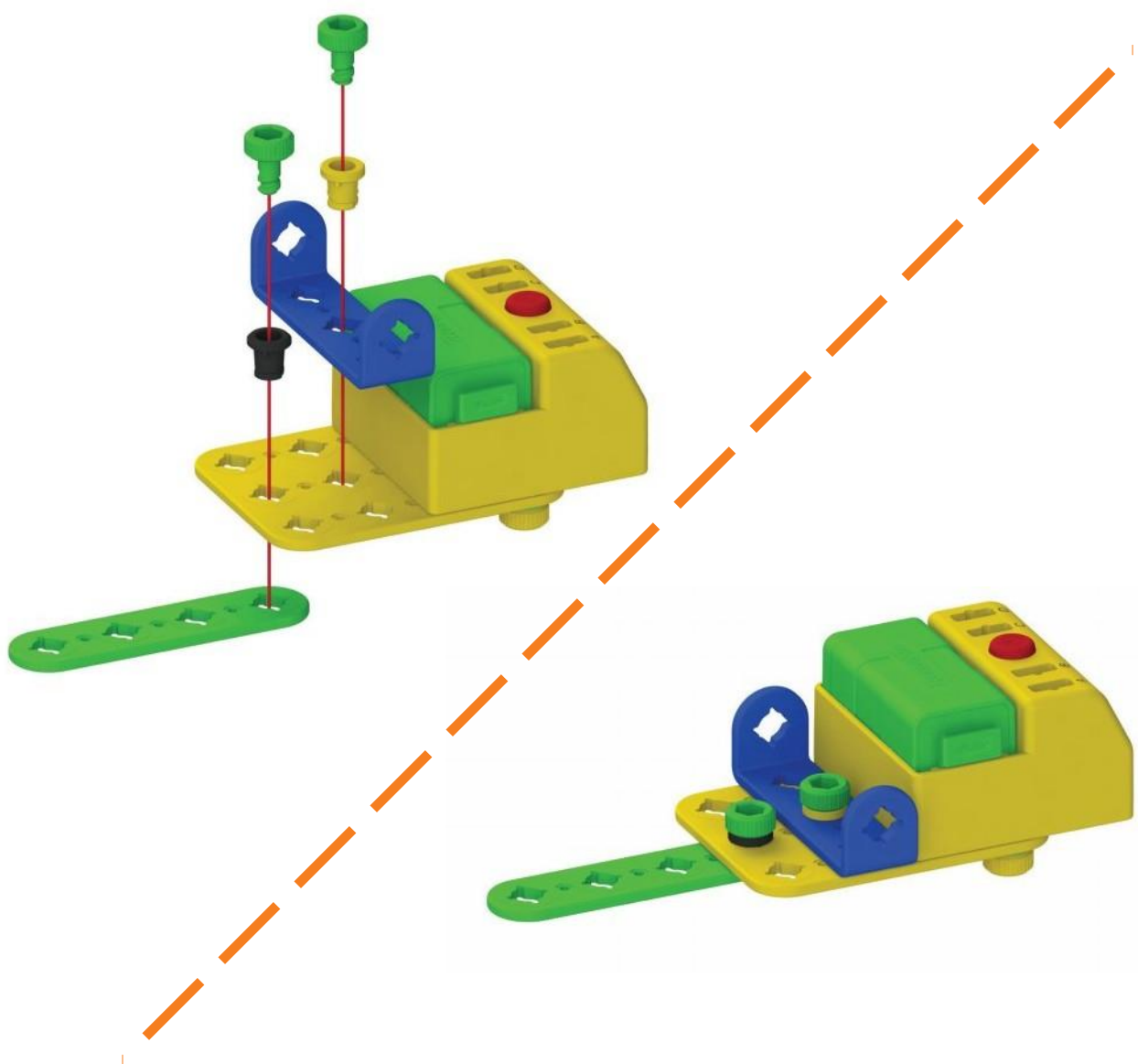

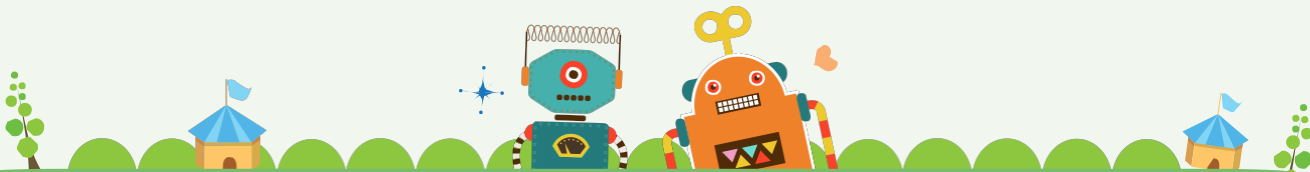

Детали



x2



x2



x2

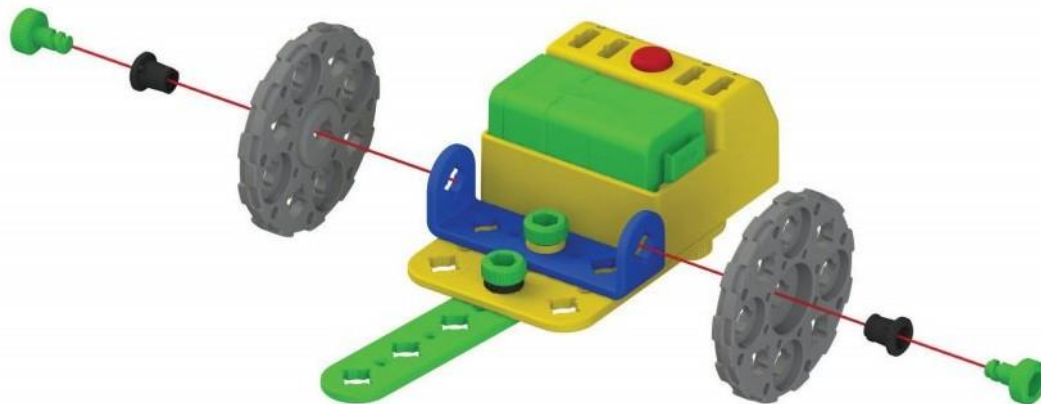

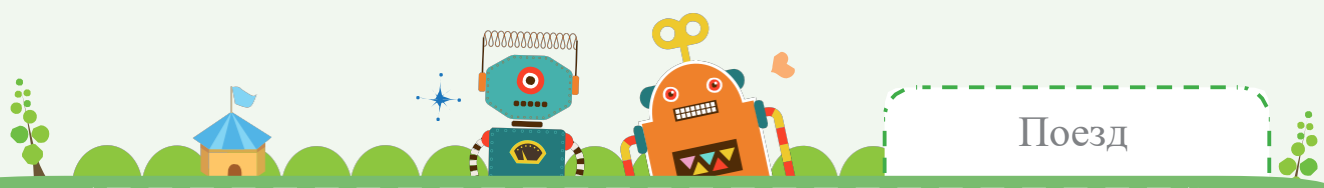

8

Детали



x1



x1

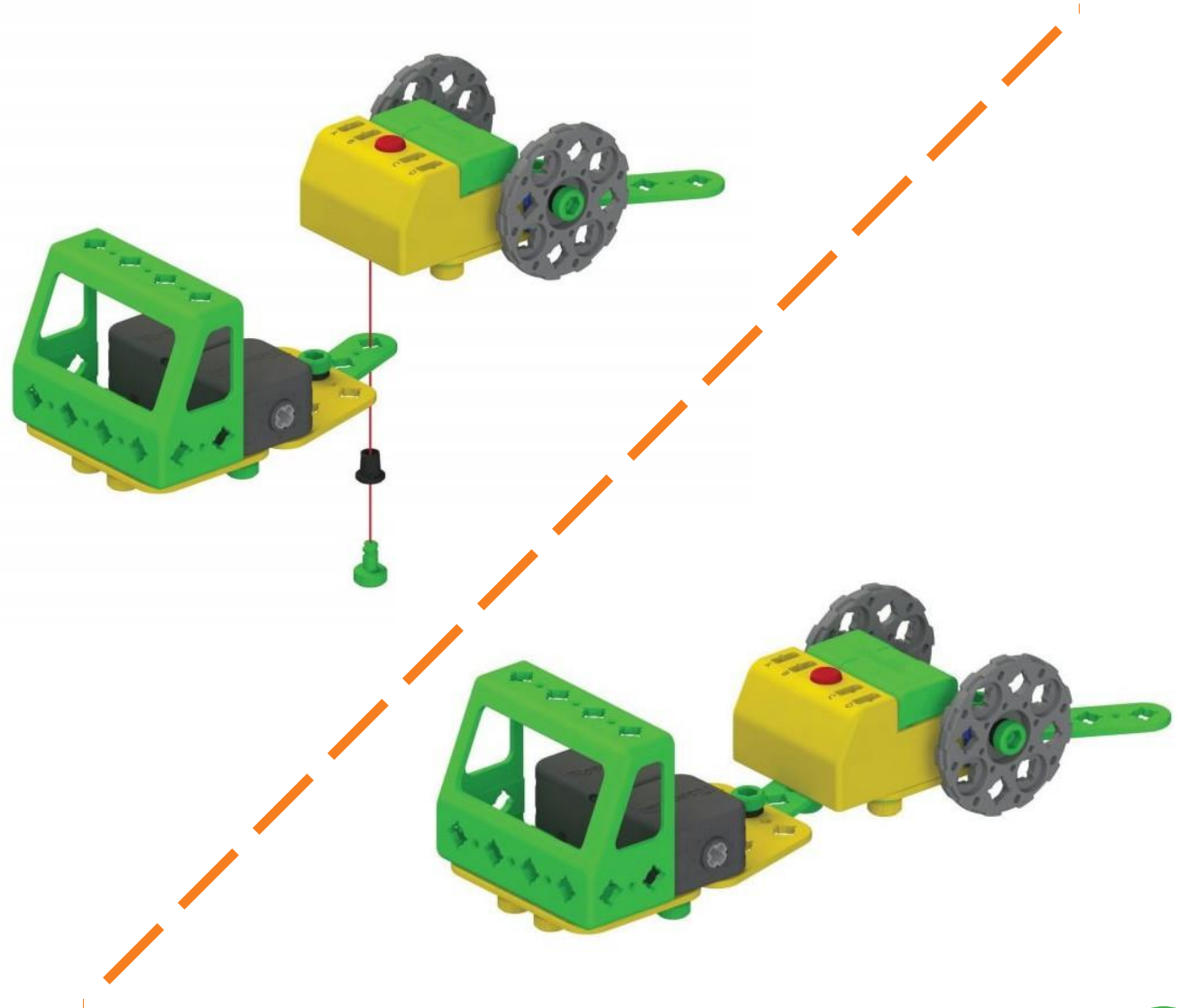

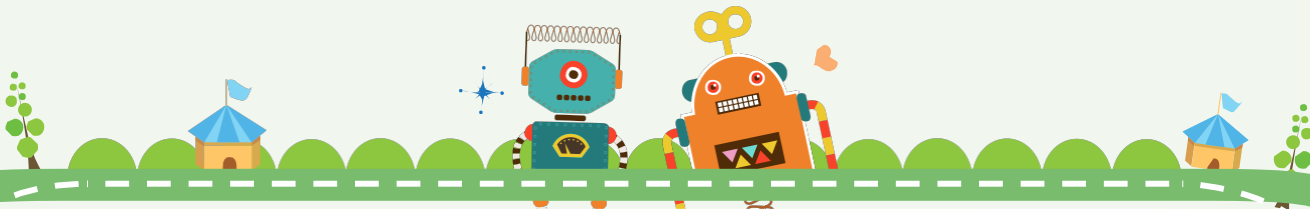

9

Детали



x1



x1



x2



x2

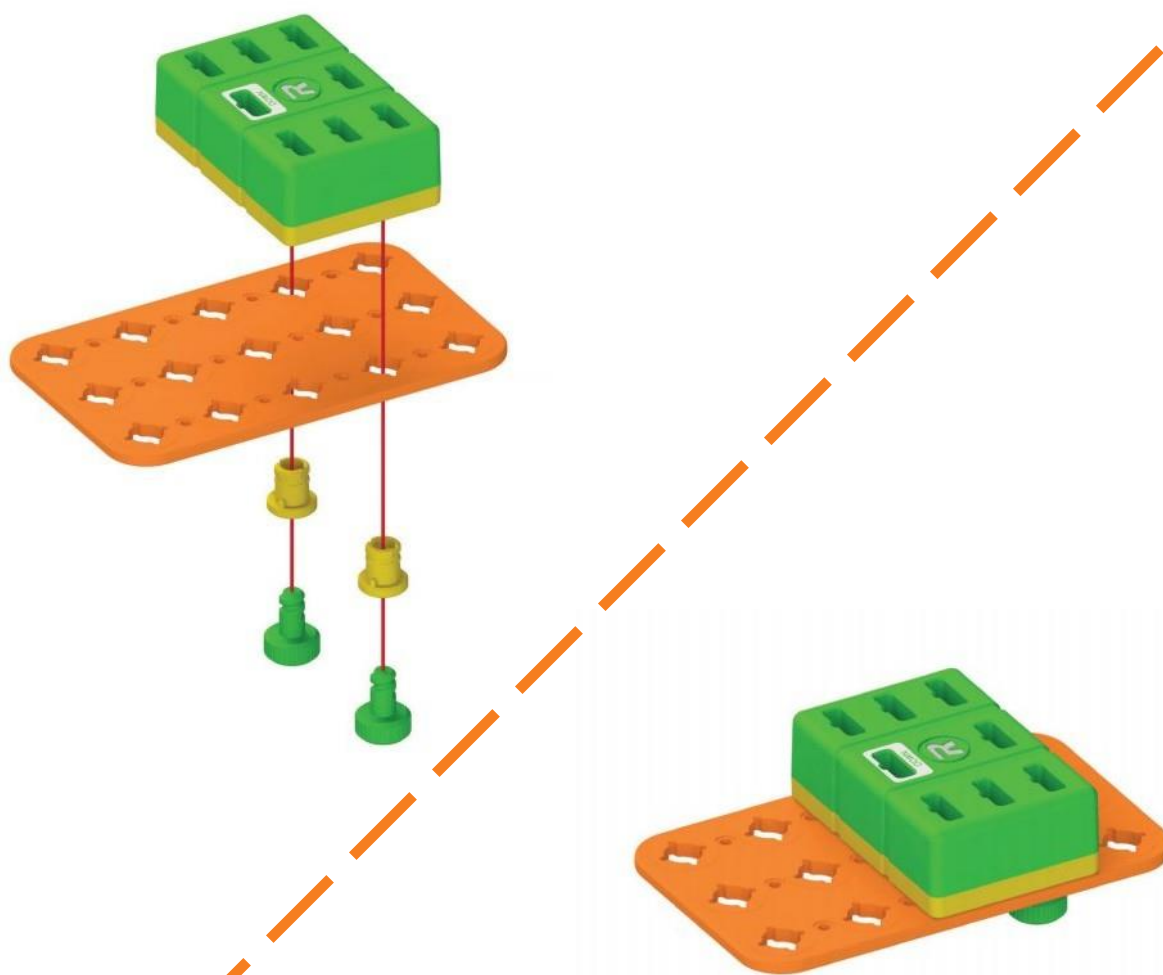



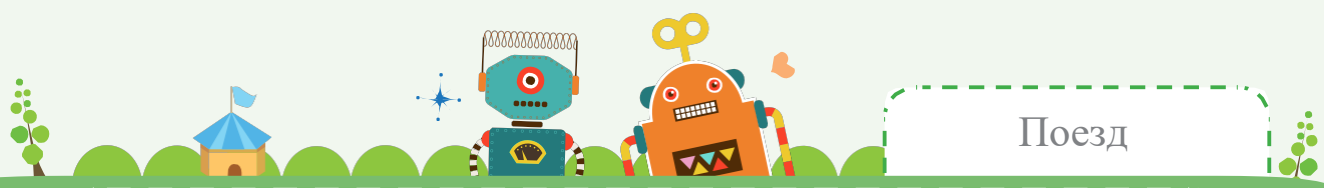

10

Детали



x1



x2



x2



x1



x1

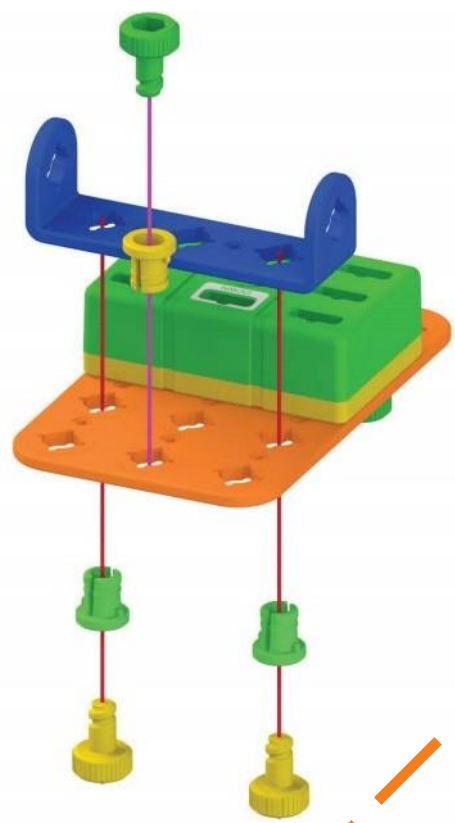

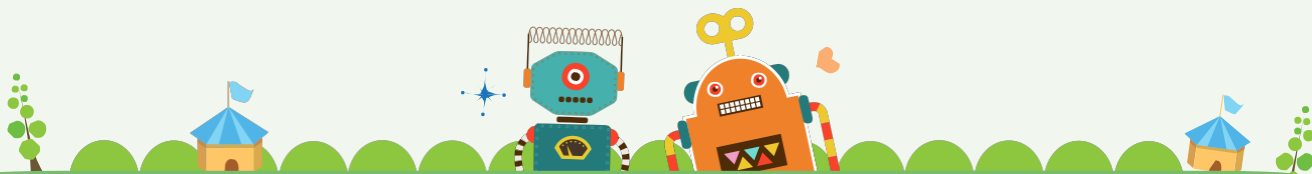

Детали



x2



x2



x2

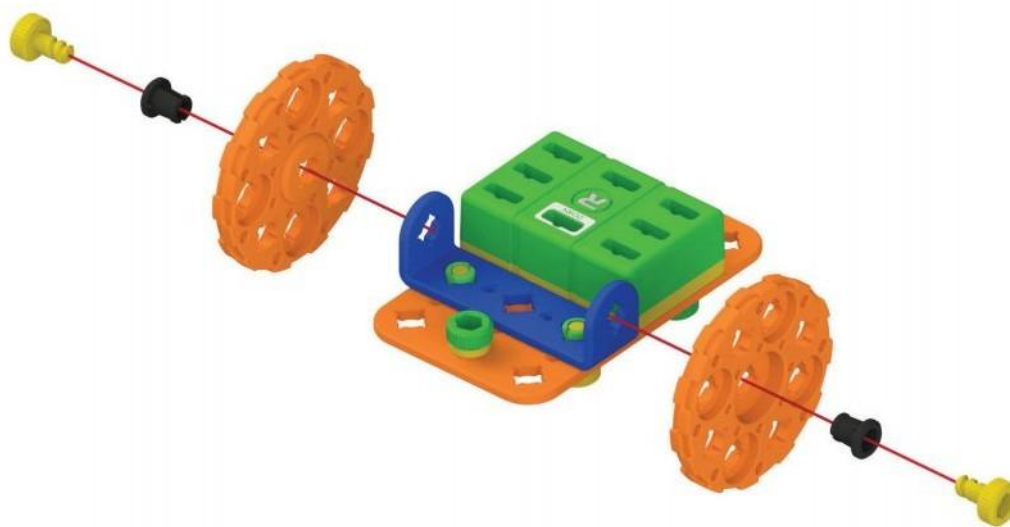

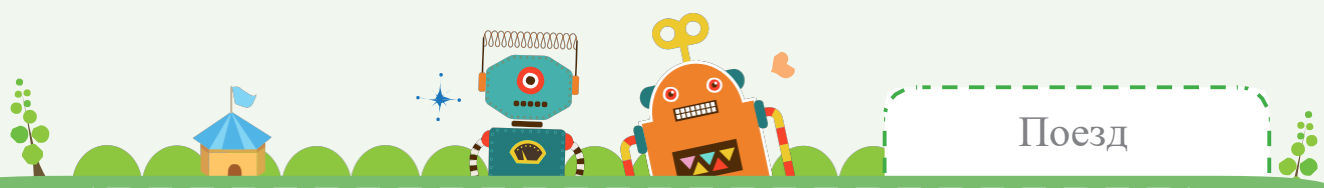

12

Детали



x1



x1

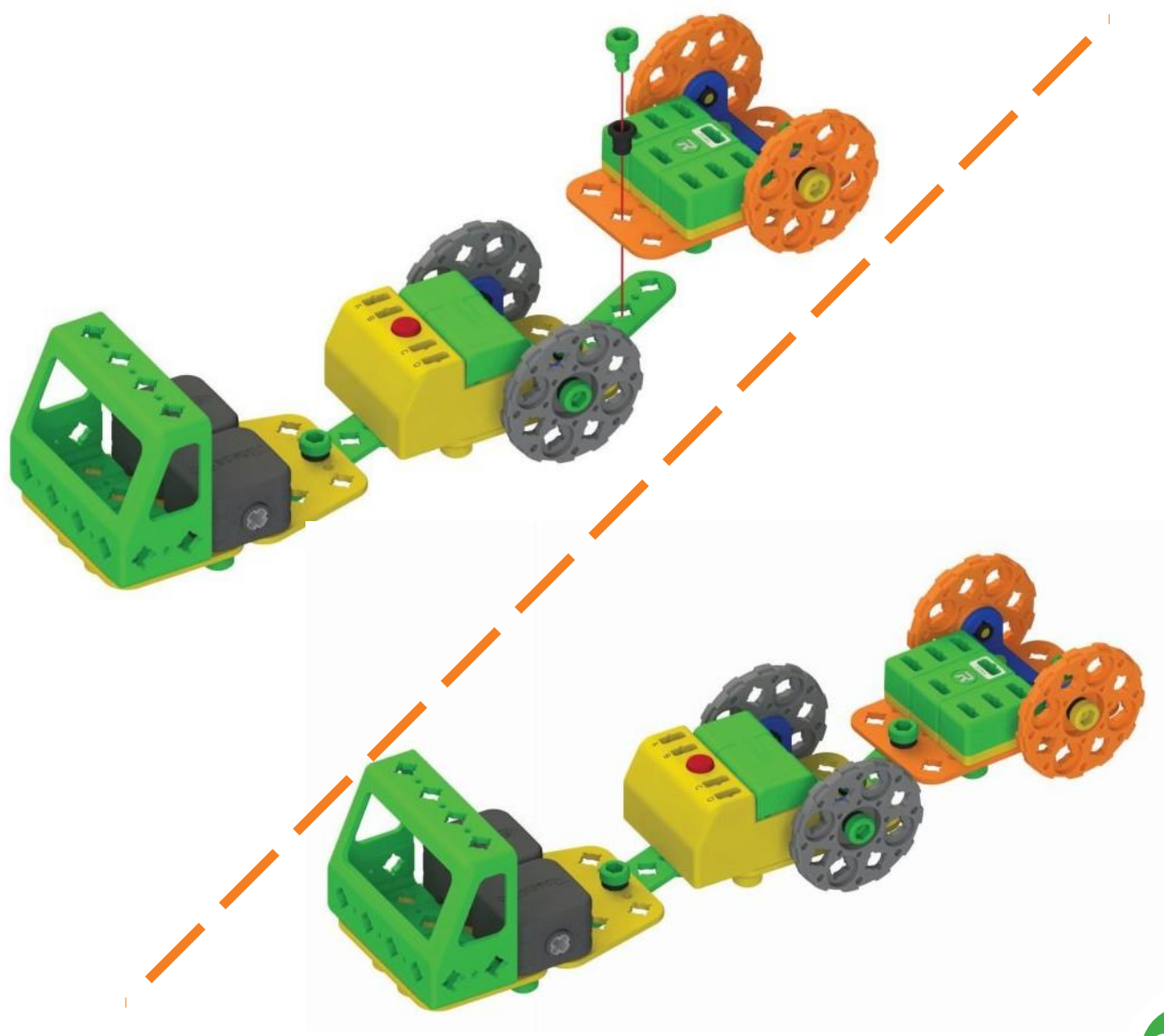

13

Детали



x2

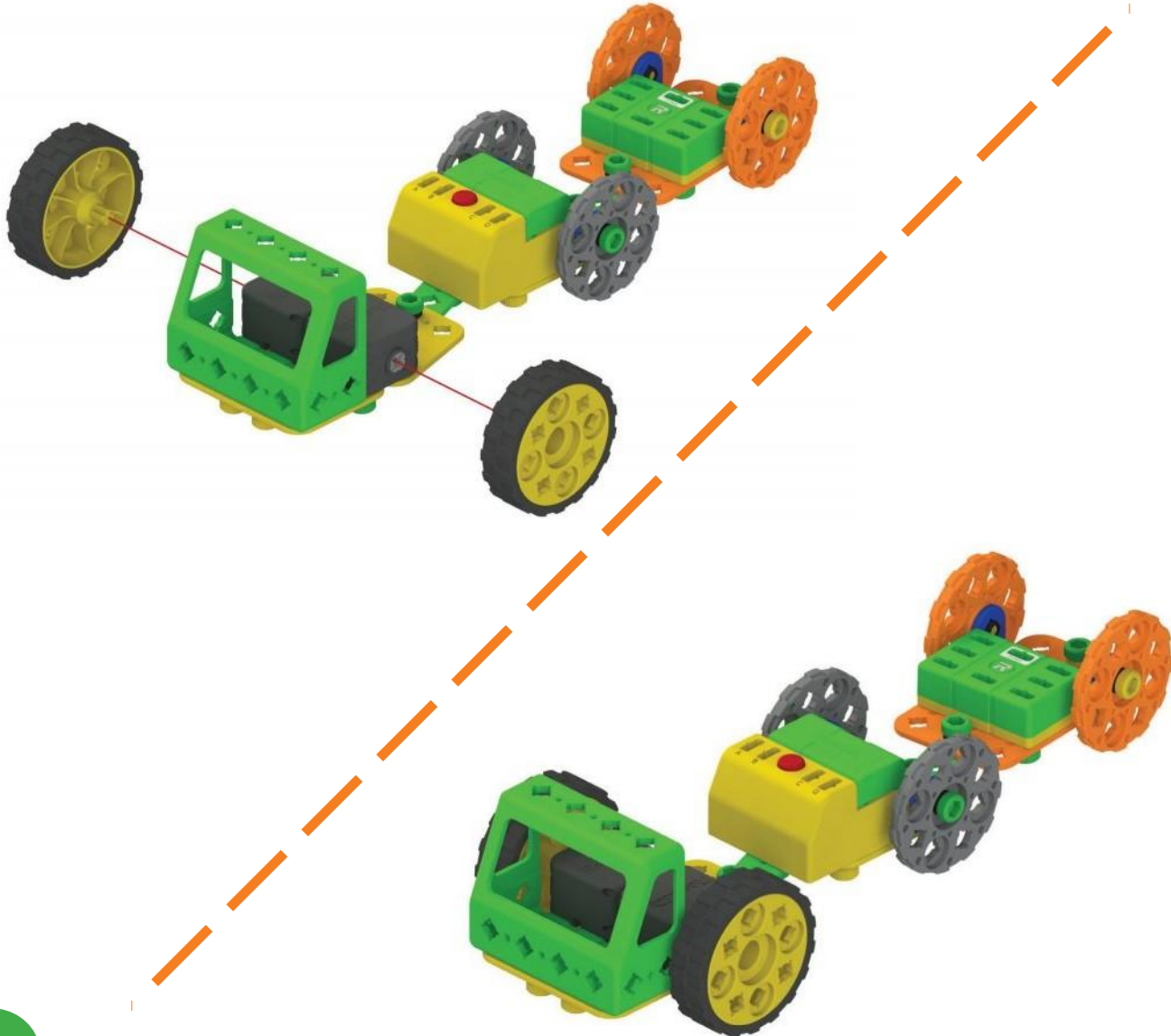

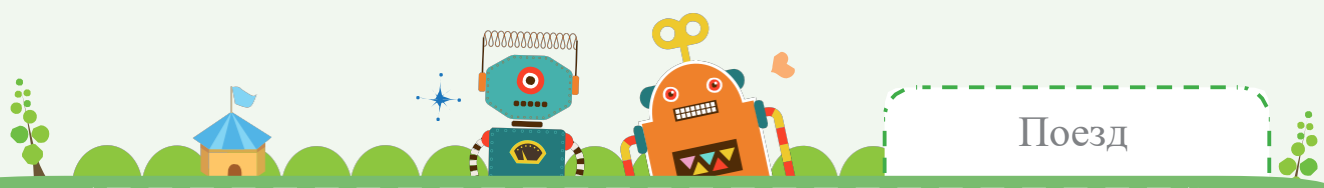

14 Детали



x1



x1

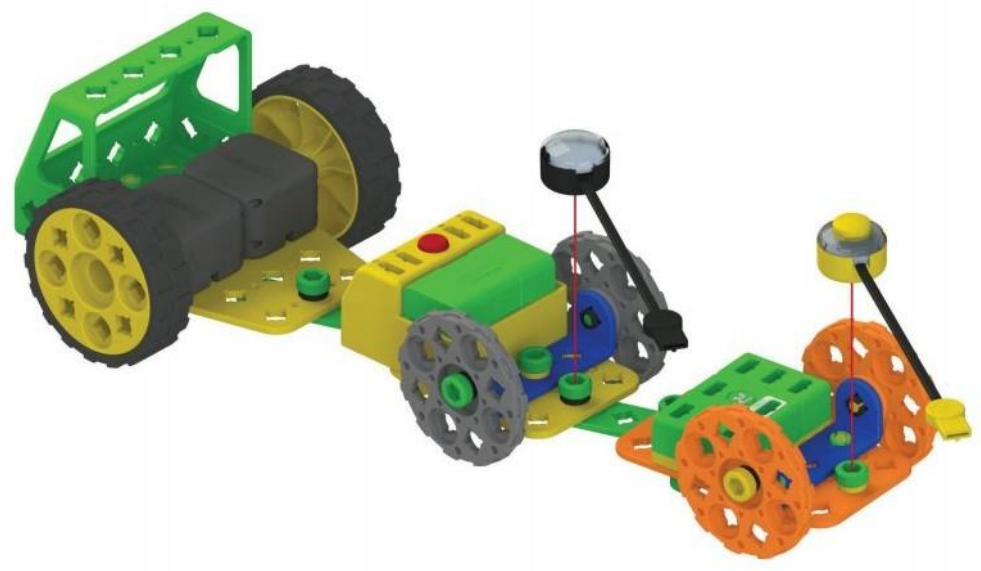



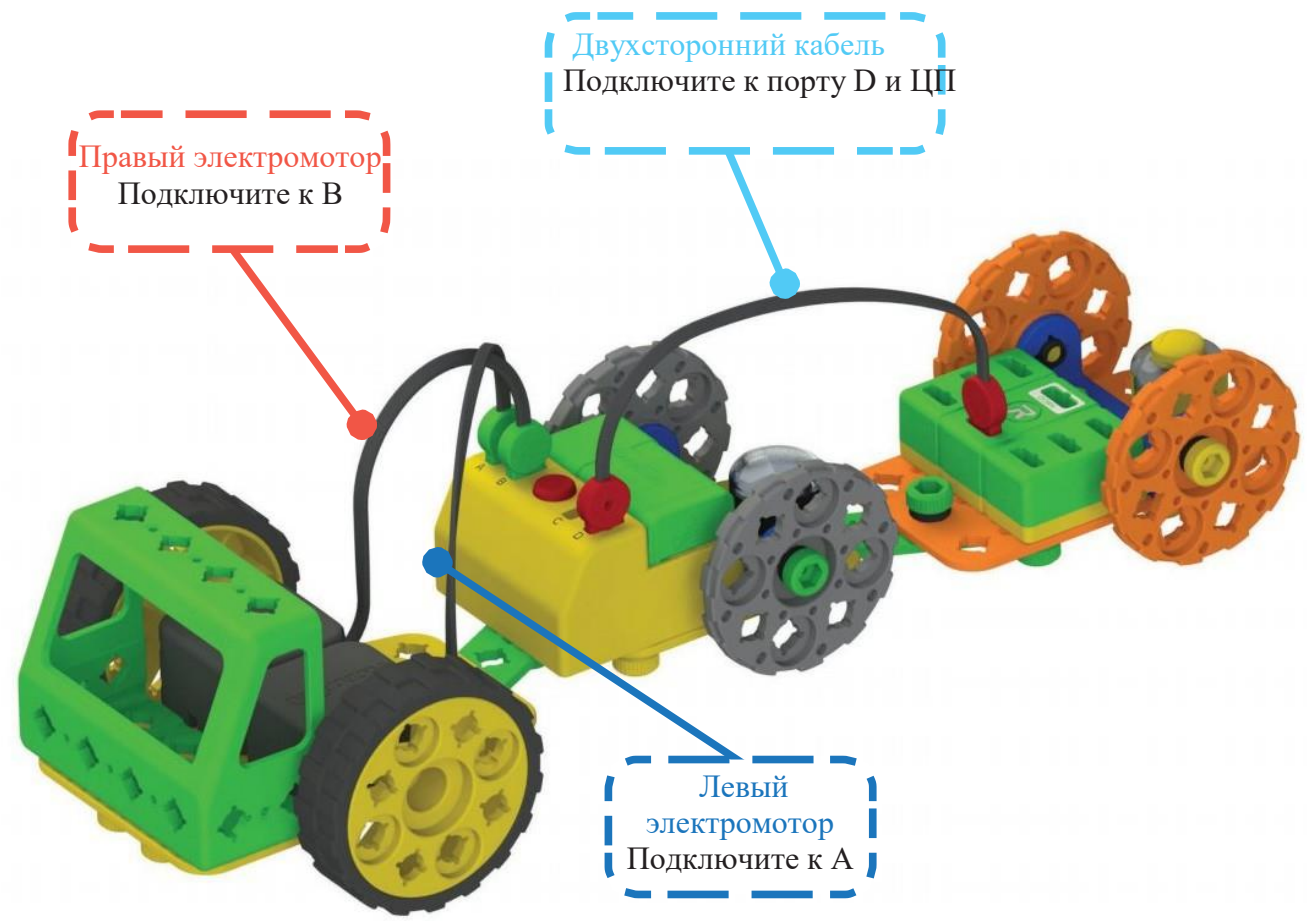
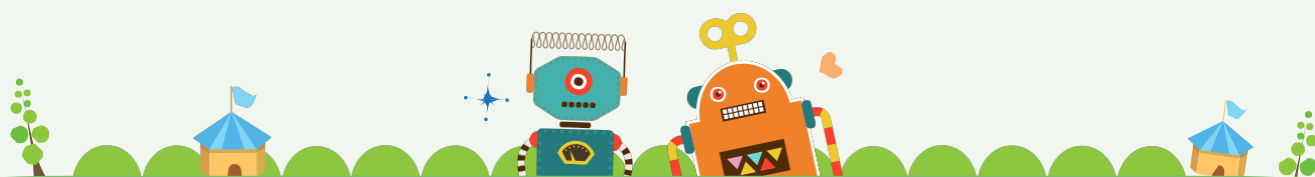

Правый электромотор  
Подключите к В

Двухсторонний кабель  
Подключите к порту D и ЦП

Левый электромотор  
Подключите к А



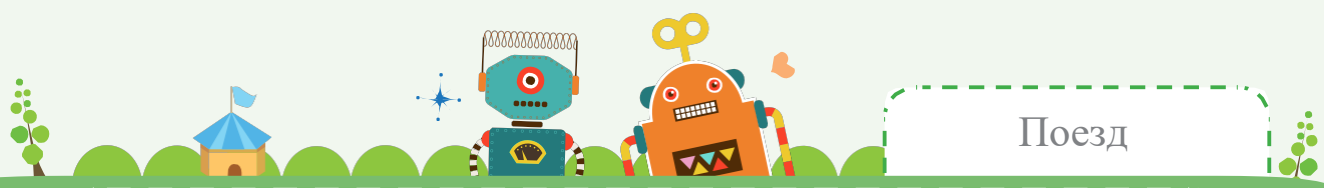

Поезд

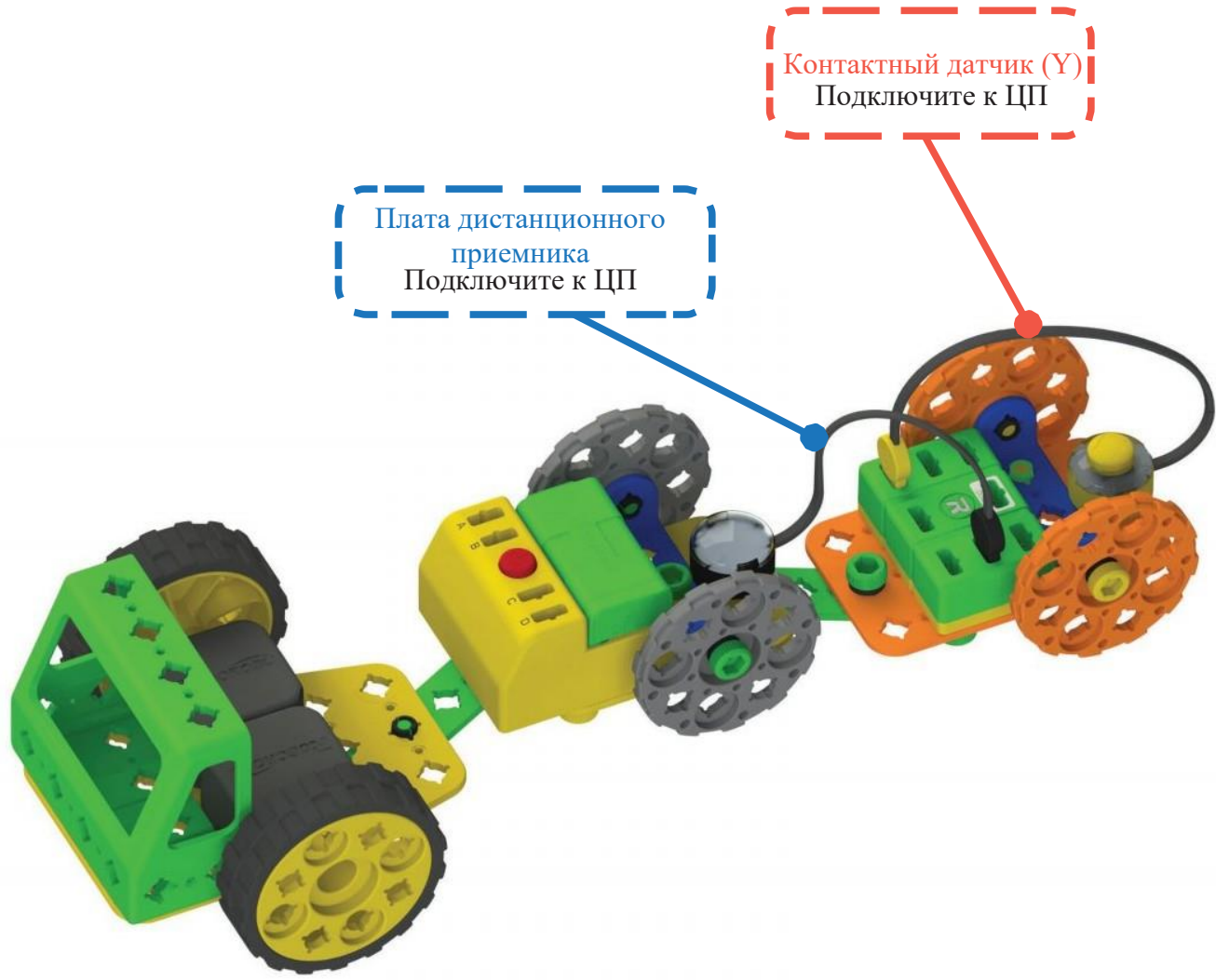

Плата дистанционного приемника  
Подключите к ЦП

Контактный датчик (У)  
Подключите к ЦП



Запрограммируем движение поезда на программной плате.

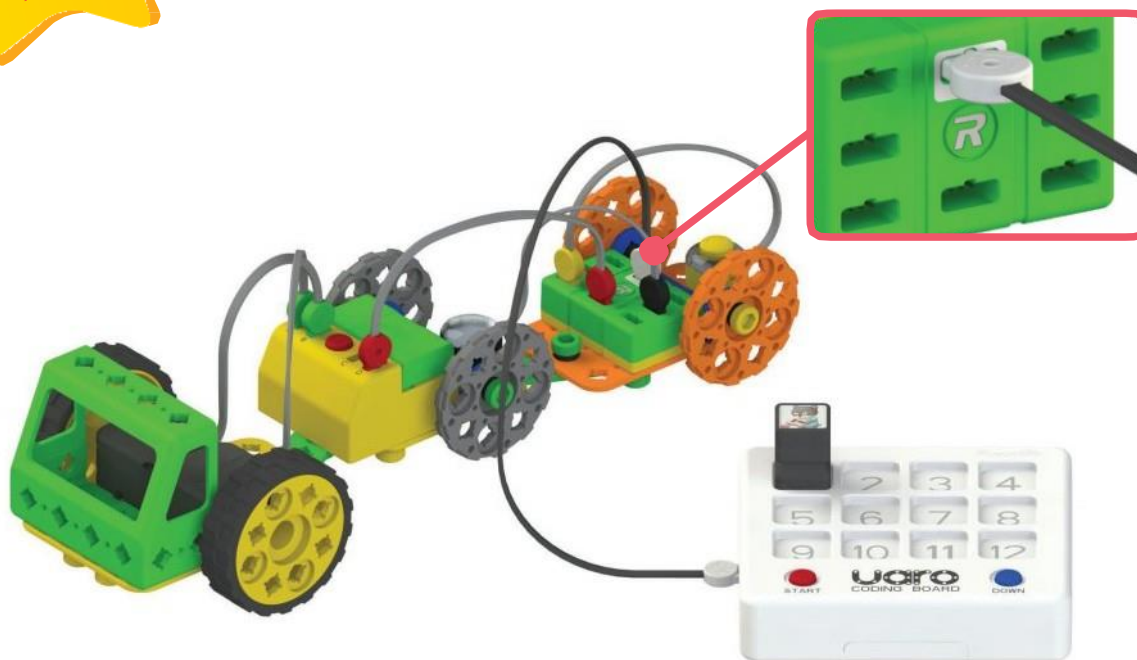

Управляйте поездом с помощью устройства дистанционного управления



## Украшение блоков

Вы можете присоединять блоки к роботам с помощью блочных рам. Попробуйте украсить роботов с помощью дополнительных блоков!



Рама 4 блока



Рама 8 блоков

Соберите блочные рамы, как показано ниже

- Для сборки блочных рам лицевой стороной ВВЕРХ



- Для сборки блочных рам лицевой стороной ВНИЗ



# Украшение блоков

## 1. Как закрепить блочную раму

Для закрепления одной блочной рамы, поместите гайку в отверстие блочной рамы так, чтоб кромки гайки плотно вошли между

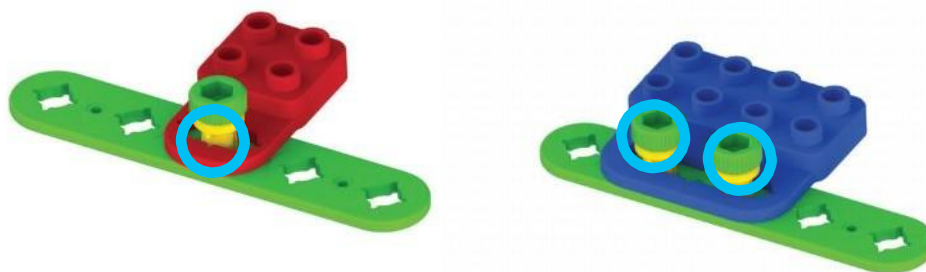

## 2. Как собрать подвижную блочную раму

При установке блока над блочными рамами, наличие подвижной блочной рамы позволяет настроить положение блочной рамы. Чтобы собрать настраиваемую блочную раму, поместите гайку в отверстие блочной рамы так, чтобы кромки гайки не плотно входили в отверстие рамы.

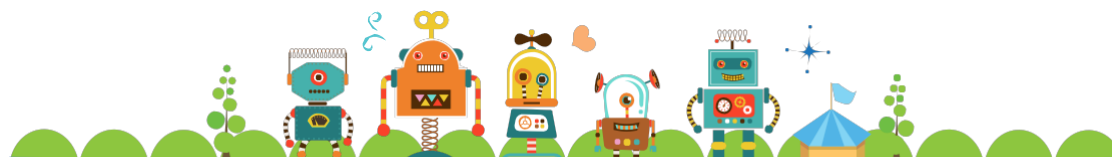
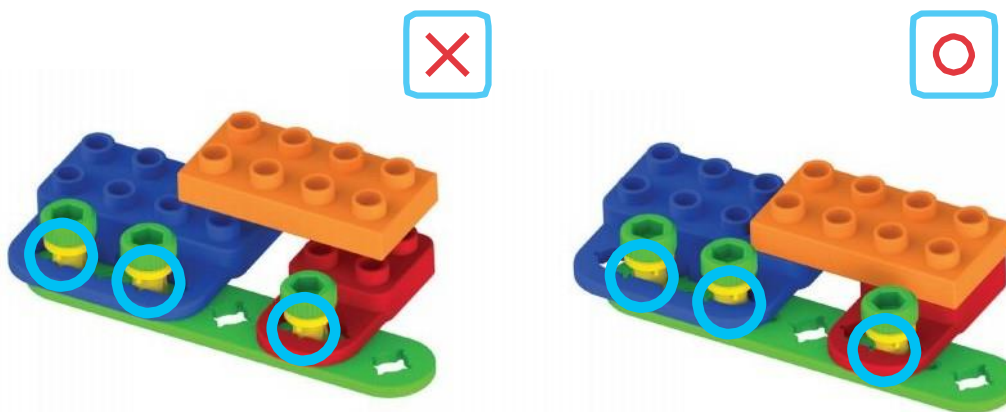

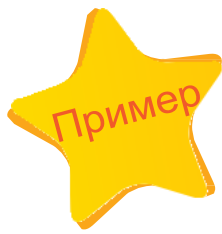

Робот для реслинга



Робот для настольных игр



Робот-футболист



Бык

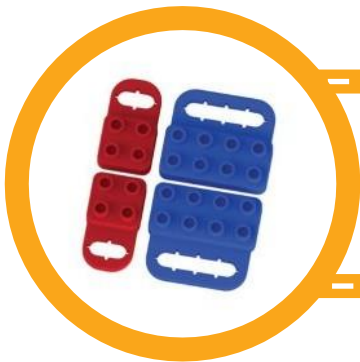

Чтобы украсить робота,  
установите блочные рамы.



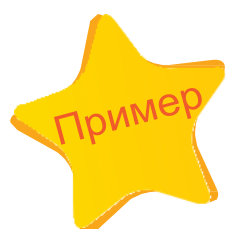

Стрекоза



Пугало



Трактор



Робот-помощник



Чтобы украсить робота,  
установите блочные рамы.





Яхта



Велосипед



Вертолет



Поезд



Чтобы украсить робота,  
установите блочные рамы.

## Меры предосторожности

1. Запрещается брать части в рот.
2. Эксплуатация, сгибание либо удаление частей с чрезмерным усилием запрещены.
3. Запрещается подставлять руки в элементы подвижных частей.
4. Запрещается бросать элементы и изделия и замахиваться ими в направлении людей.
5. Требуется соблюдение осторожности при касании острых граней частей.
6. Беречь детали от огня
7. Электронные компоненты могут перестать работать при воздействии на них воды
8. Устанавливайте батареи с учетом правильной полярности "+" и "-" в целях предотвращения ее взрыва или протечки
9. Запрещается нагревать или разбирать батареи
10. Запрещается использовать батареи различных типов
11. При попадании жидкости из батареи в глаза, необходимо незамедлительно промыть их большим количеством воды, после чего обратиться за консультацией к врачу в кратчайшие сроки
12. При попадании жидкости из батареи на кожу или одежду, необходимо тщательно вымыть ее чистой водой с мылом. При покраснении кожи обратитесь к врачу
13. Выполнять сборку разрешается под контролем преподавателя или руководством/надзором родителей
14. Так как в наборе содержатся мелкие детали, данный набор не предназначен для использования детьми в возрасте до 3-х лет. Опасность удушья.



### Мир интерактивного программирования

Автор: Jungmi Park, Seunghwan Sin, Youngsuk Choi

Первое издание: 22 февраля 2016 г.

Дата Публ.: 22 февраля 2016 г.

Издательство: RoboRobo Co., LTD.

Авторское право © Roborobo Co., LTD. Все права защищены.

※ Отпечатано в Республике Корея. Настоящее издание защищено авторским правом. Для воспроизведения, хранения в системах автоматического поиска, передачи третьим лицам в любом виде и любыми средствами, включая электронные и механические, копирование, запись и пр., требуется надлежащее разрешение со стороны Издателя. По вопросам получения разрешений обращаться к: RoboRobo Co., LTD.

RoboRobo Bldg., DobongRo 54-6, Mia-Dong, GangBuk-Gu, Сеул, Южная Корея

Тел.: 82-2-909-5050 или 82-1577-5060 Факс: 82-2-917-3511

2-й - Робот для настольных игр



6-й - Пугало



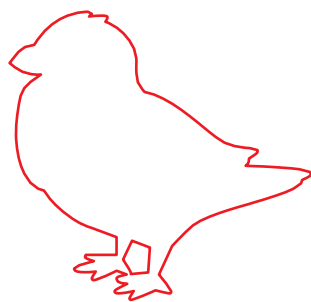
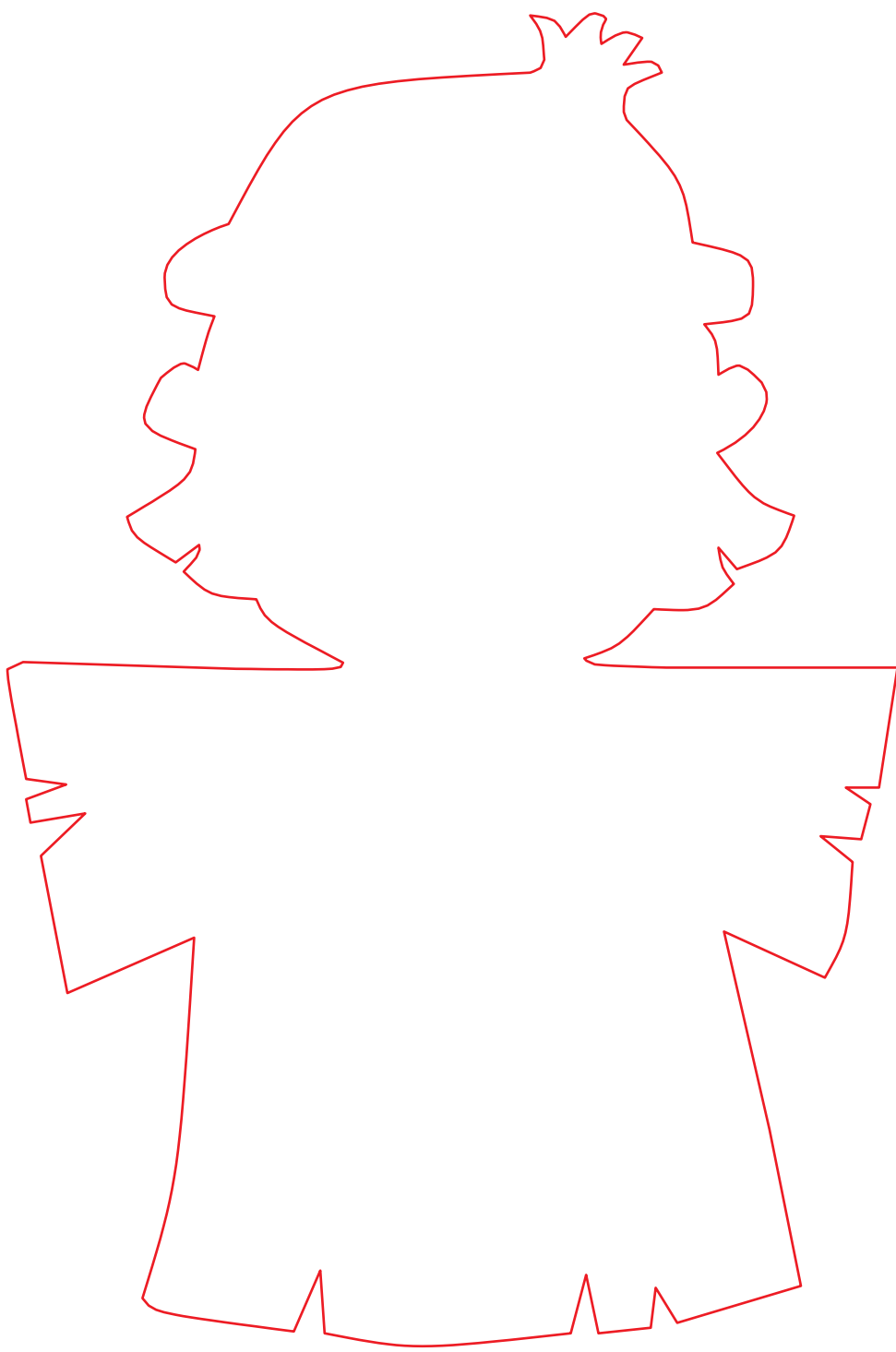
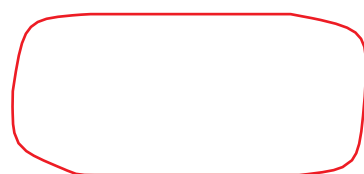



# Наклейки глаз

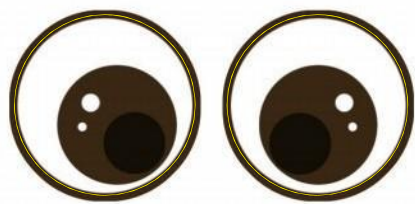
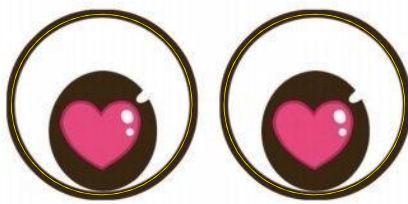
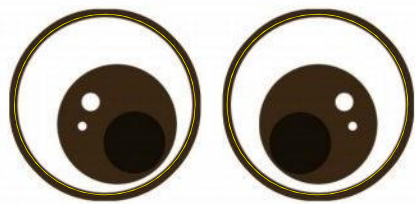
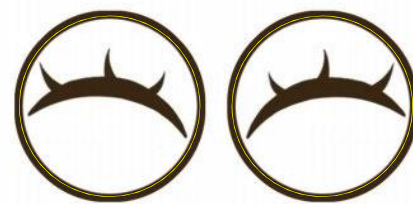
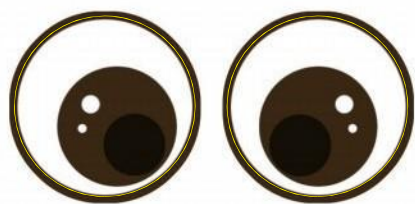
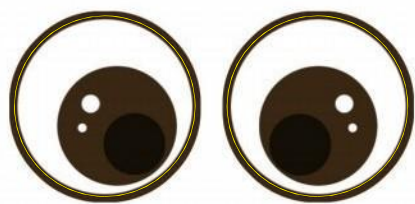
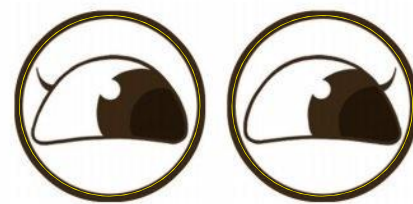
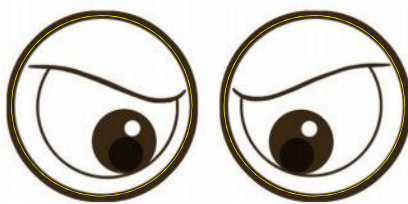
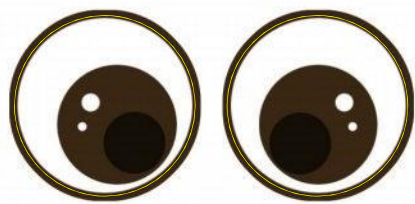
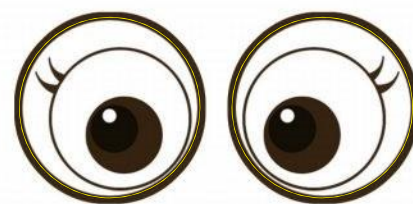
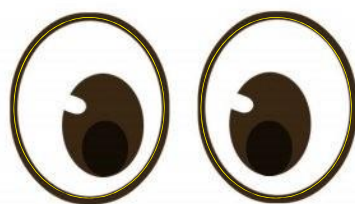
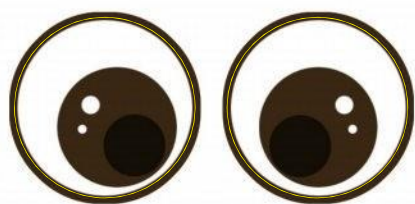

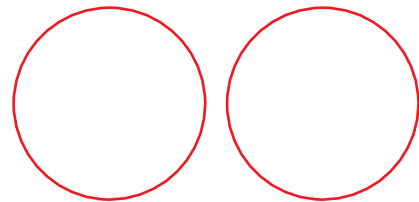
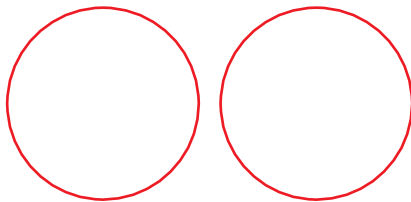
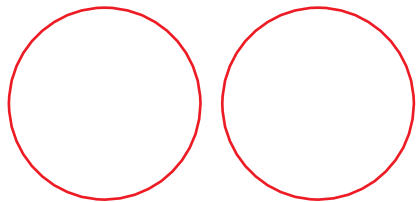
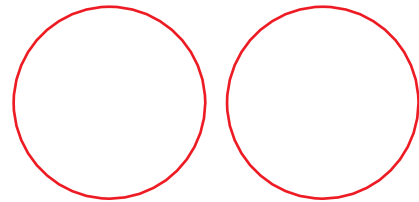
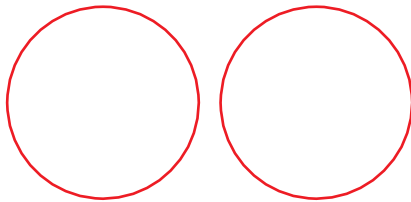
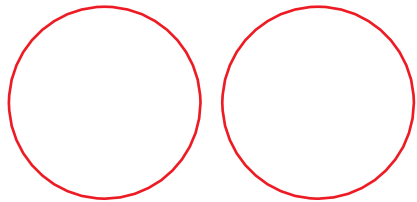
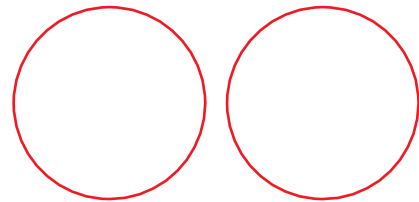
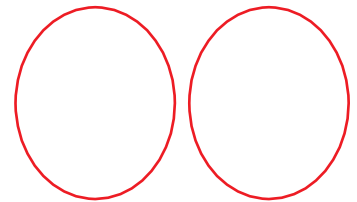
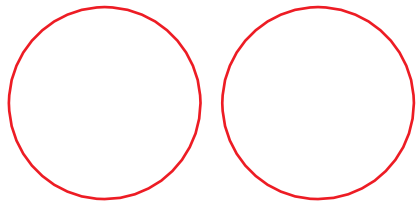
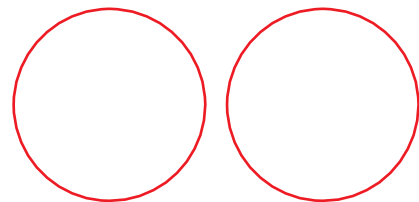
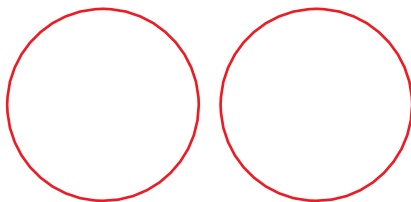
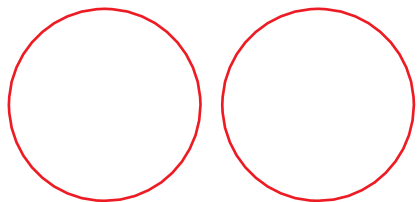
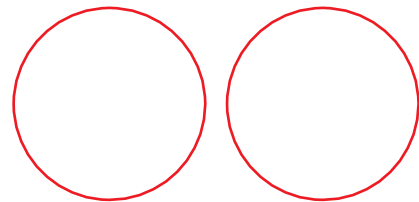
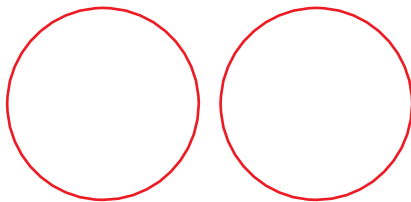
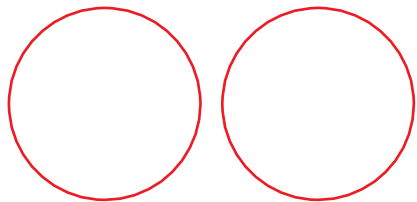
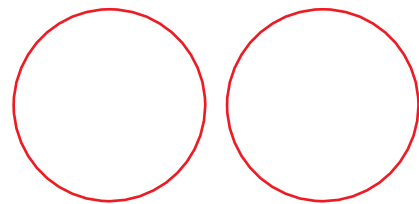
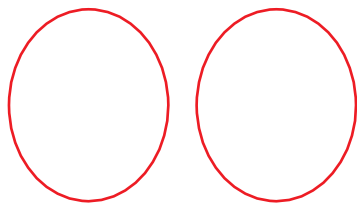
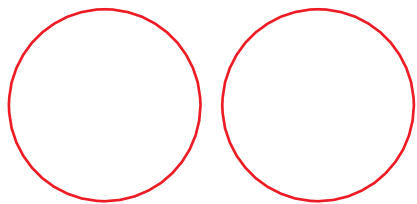





# Перечень частей:



□ рама 8 x 2



□ рама 10 x 1

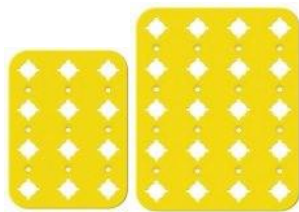

□ рама 12 x 1

□ рама 20 x 1



C-рама x 2

□ рама 4 x 2



Малое колесо (O) x 2



Рама 8 блока x 2



Мягкая рука x 2



Инфракрасный датчик x 1



Кабель программной платы x 1



Блок движения x 7



Блок LED (O) x 3



Болт (Y) x 3

Гайка (Y) x 3

Болт (G) x 3

Гайка (G) x 3

Длинный болт (B) x 2

Длинная гайка (B) x 2

Длинный болт (R) x 2

Длинная гайка (R) x 2

Поворотная гайка x 3



Блок контактного датчика x 2



Блок LED (B) x 3



Блок инфракрасного датчика x 1



Блок дистанционного управления x 1



Наклейки глаз x 1



Программная плата x 1



## ПРОГРАММИРОВАНИЕ РОБОТА

Мир интерактивного программирования



Робот для рессинга



Робот для настольных игр



Робот - футболист



Бык



Стрекоза



Пугало



Трактор



Робот-помощник



Яхта



Велосипед



Вертолет



Поезд

**ROBOROBO**  
www.roborobo.co.kr

