

4

Инструкция по сборке

ROBOROBO  
www.roborobo.co.kr

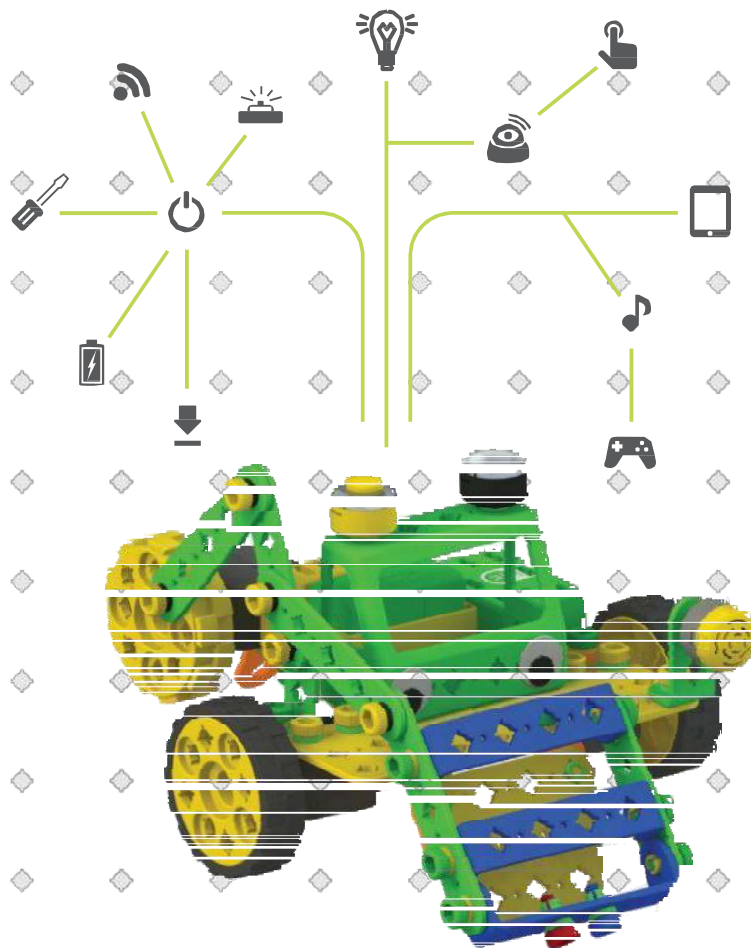

uvaro

ПРОГРАММИРОВАНИЕ РОБОТА



4-й





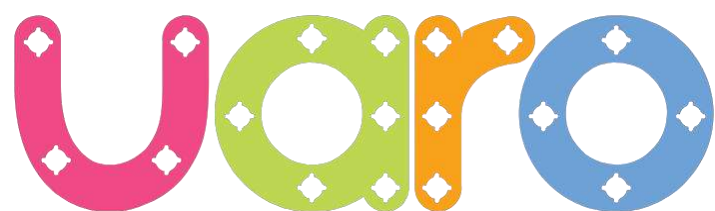

ПРОГРАММИРОВАНИЕ РОБОТА

Мир интерактивного программирования

# Меры предосторожности



Запрещается брать детали в рот



Запрещается бросать детали в других



Запрещается бросать детали в воду

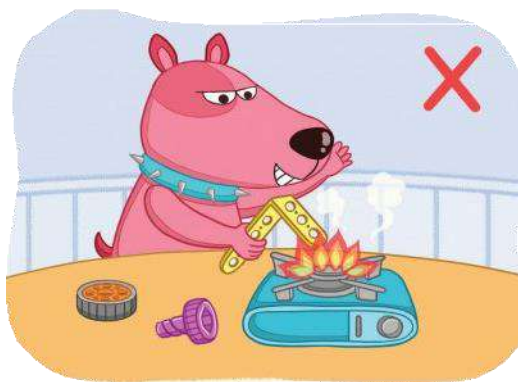

Беречь детали от огня



Выполнять сборку только под контролем руководителя



После работы необходимо убрать рабочее место

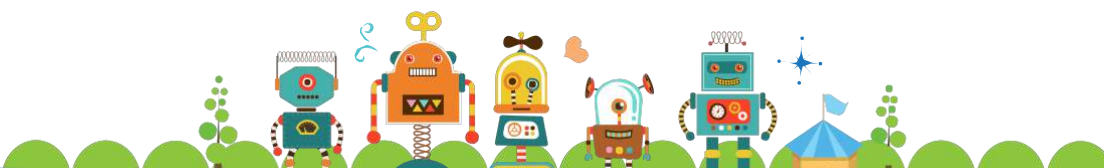

## Программный блок



К UARO 4 добавлены новые программные блоки. Благодаря новым блокам, вы сможете создавать больше забавных движений с помощью планшета, подключаемого к программной плате.

## Bluetooth-модуль



С помощью Bluetooth-модуля, вы сможете подключать планшет к программной плате беспроводным способом. С помощью планшета вы сможете использовать больше функций программного блока.



**1** Откройте крышку батарейного отсека на задней стороне платы.



**2** Установите Bluetooth-модуль. (Учитывайте правильное направление антенны)

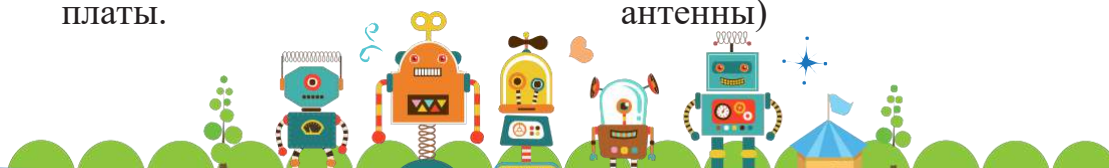



## Как подключить планшет к программной плате:

Чтобы воспользоваться функциями новых программных блоков, необходимо подключить планшет к программной плате. Запустите приложение для программирования роботов «UARO with Coding Friends» и следуйте пошаговой инструкции, приведенной ниже.



**1** Включите программную плату



**2** Запустите приложение



**3** Нажмите на кнопку пуска



**4** Идентифицируйте программную плату



**5** Выберите программную плату



**6** Нажмите на кнопку подтверждения

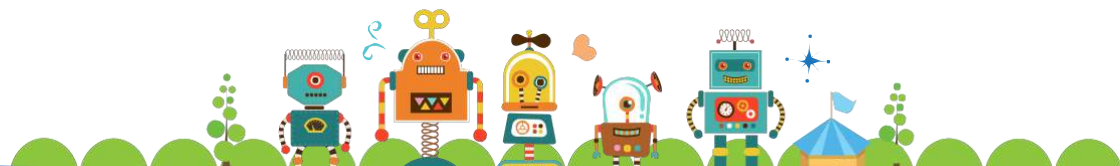

## Как подключить планшет к программной плате:

После подключения планшета к программной плате, на планшете отобразятся этапы программирования, как показано ниже.



Сразу после установки программного блока на плату, этот программный блок отобразится на планшете в соответствующей ему точке.

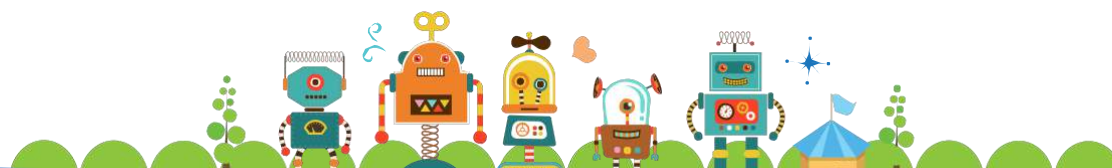

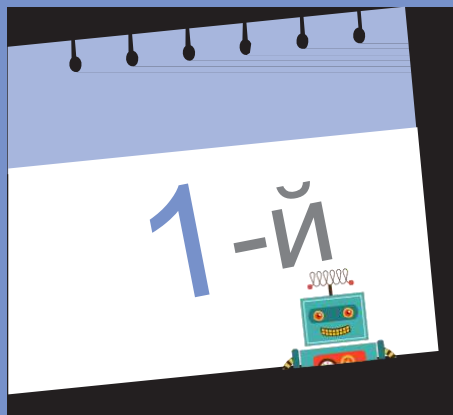

Сыграем с роботом-лыжником!

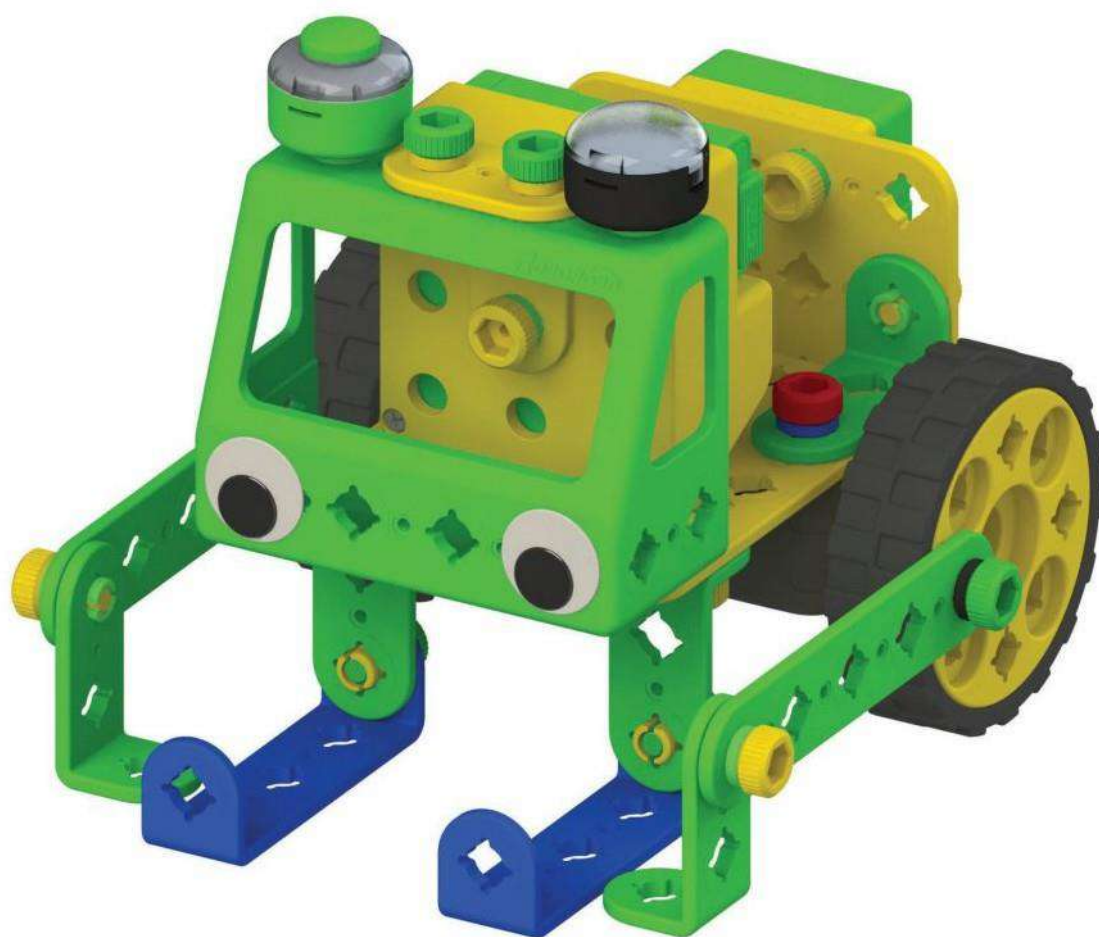



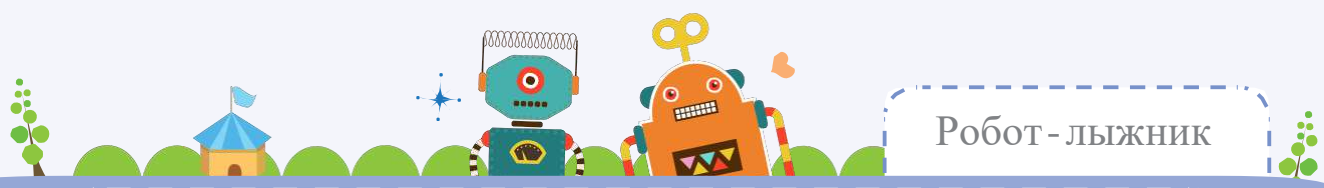

Детали



x1



x2



x2



x2

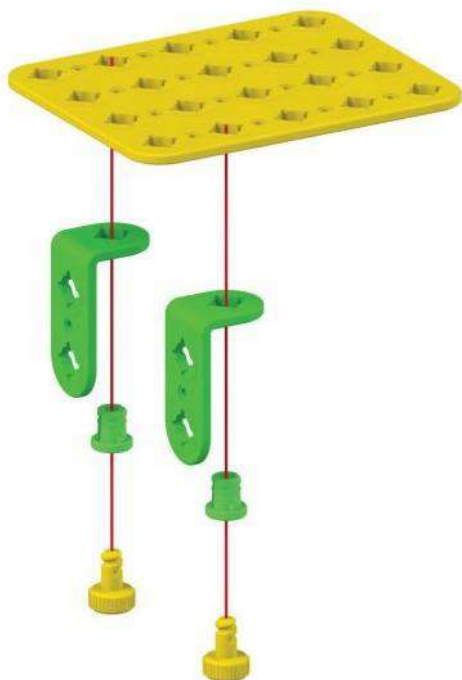

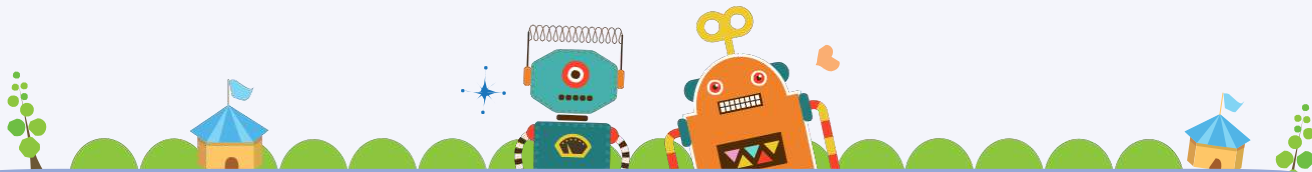

2

Детали



x1



x2



x2

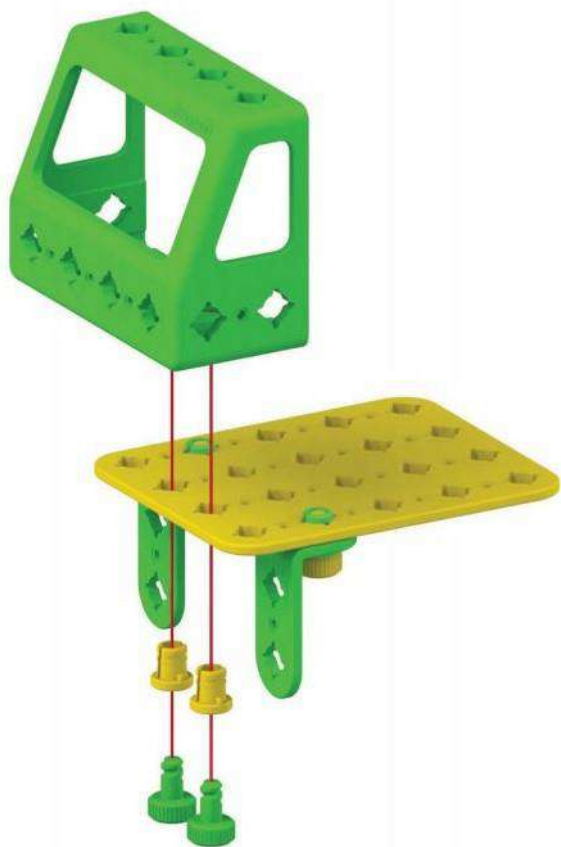

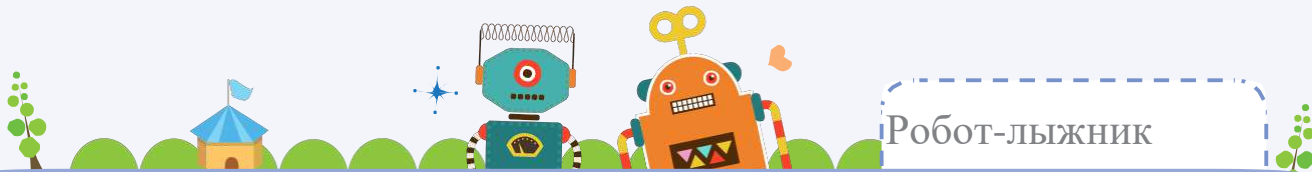

3

Детали



x2



x2



x2

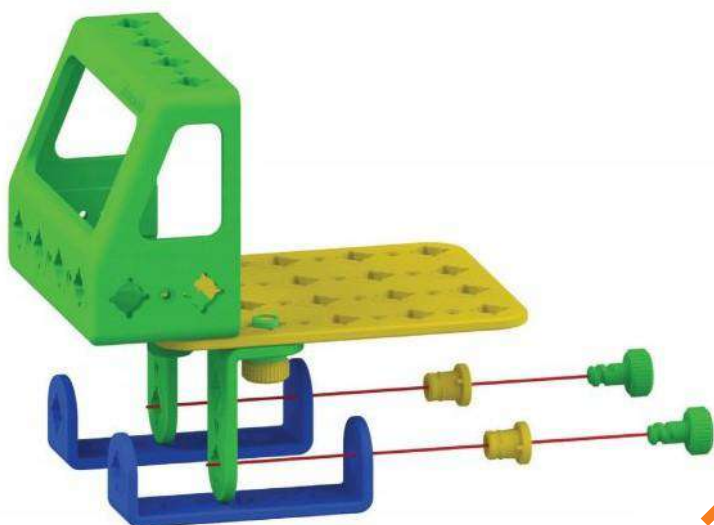

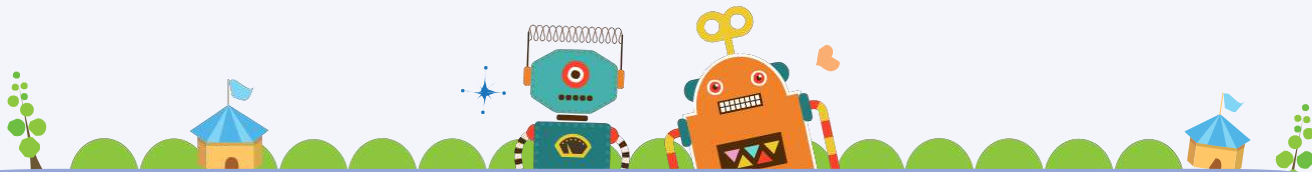

4

Детали



x2



x2



x2

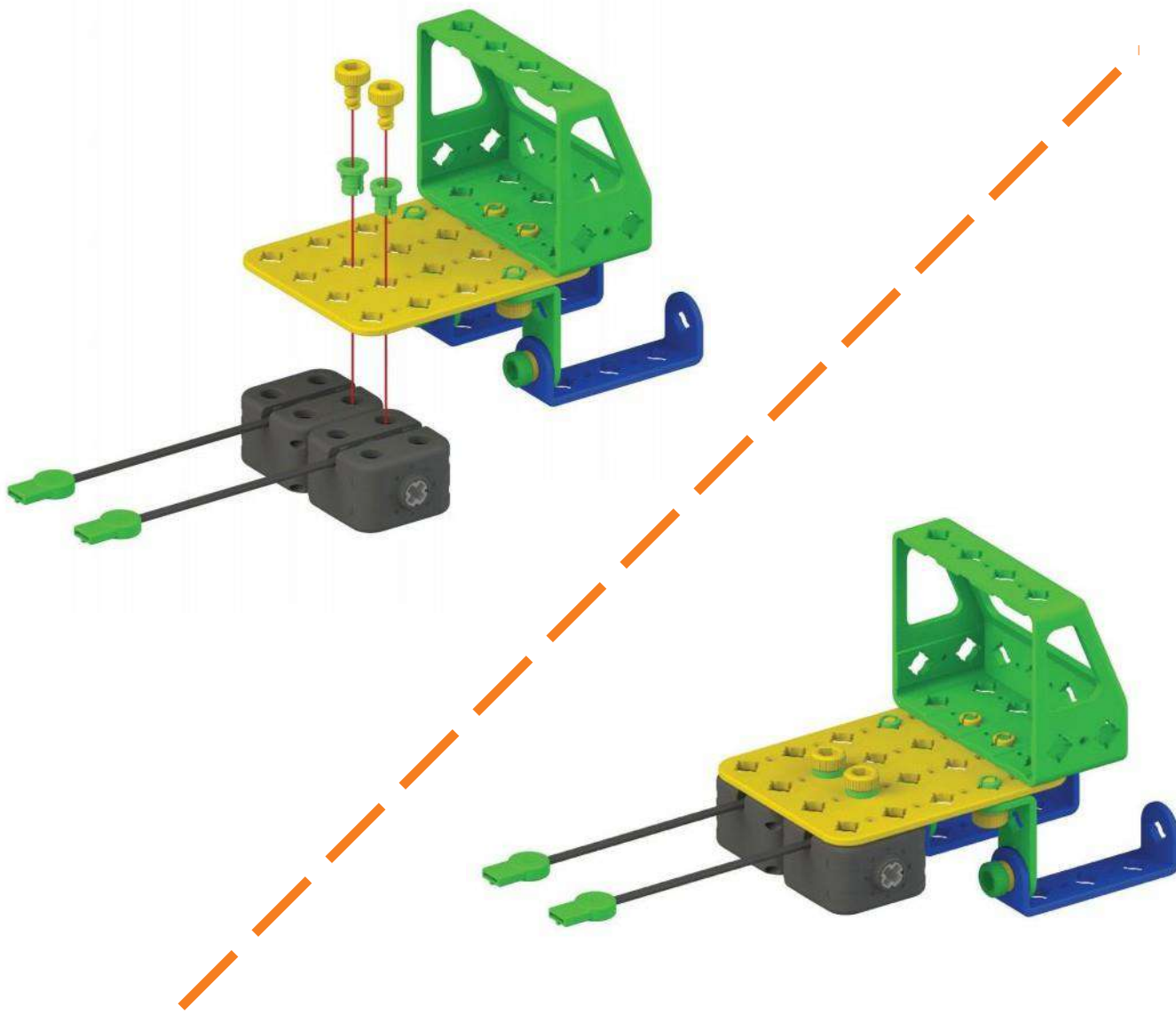

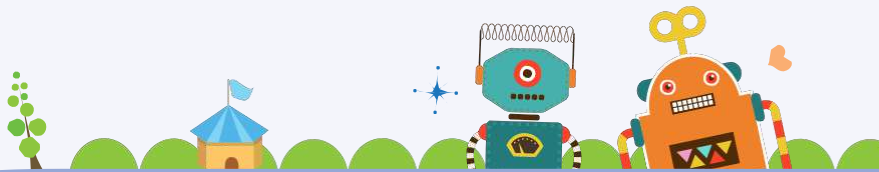

5

Детали



x1



x2



x2



x2

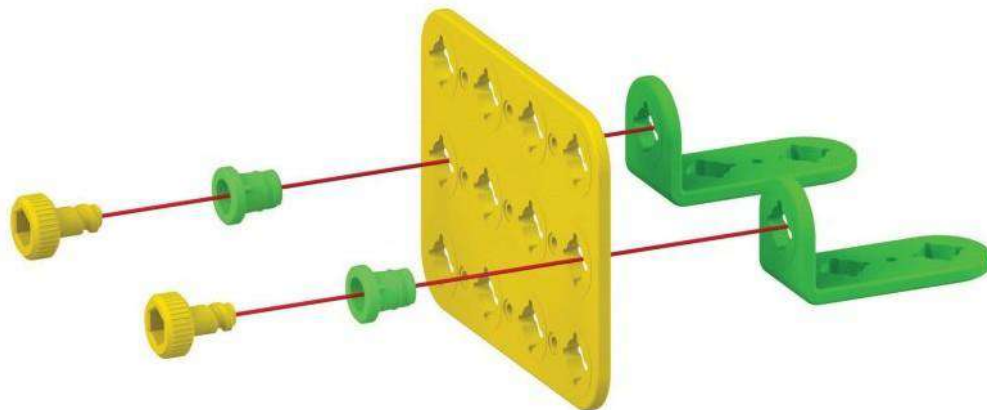

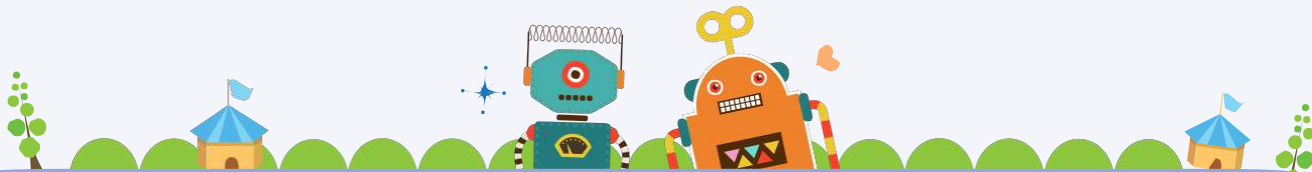

6

Детали



x1



x2



x2

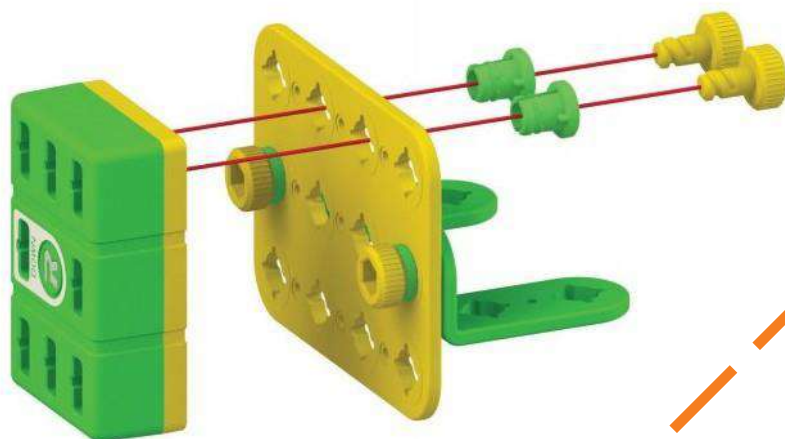

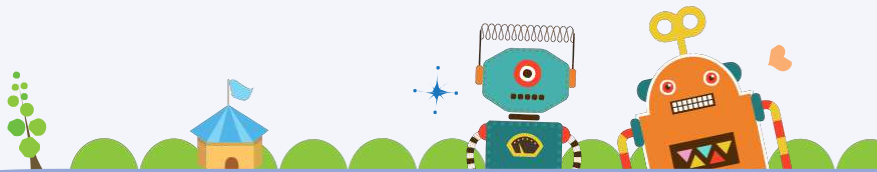

Детали



x2



x2

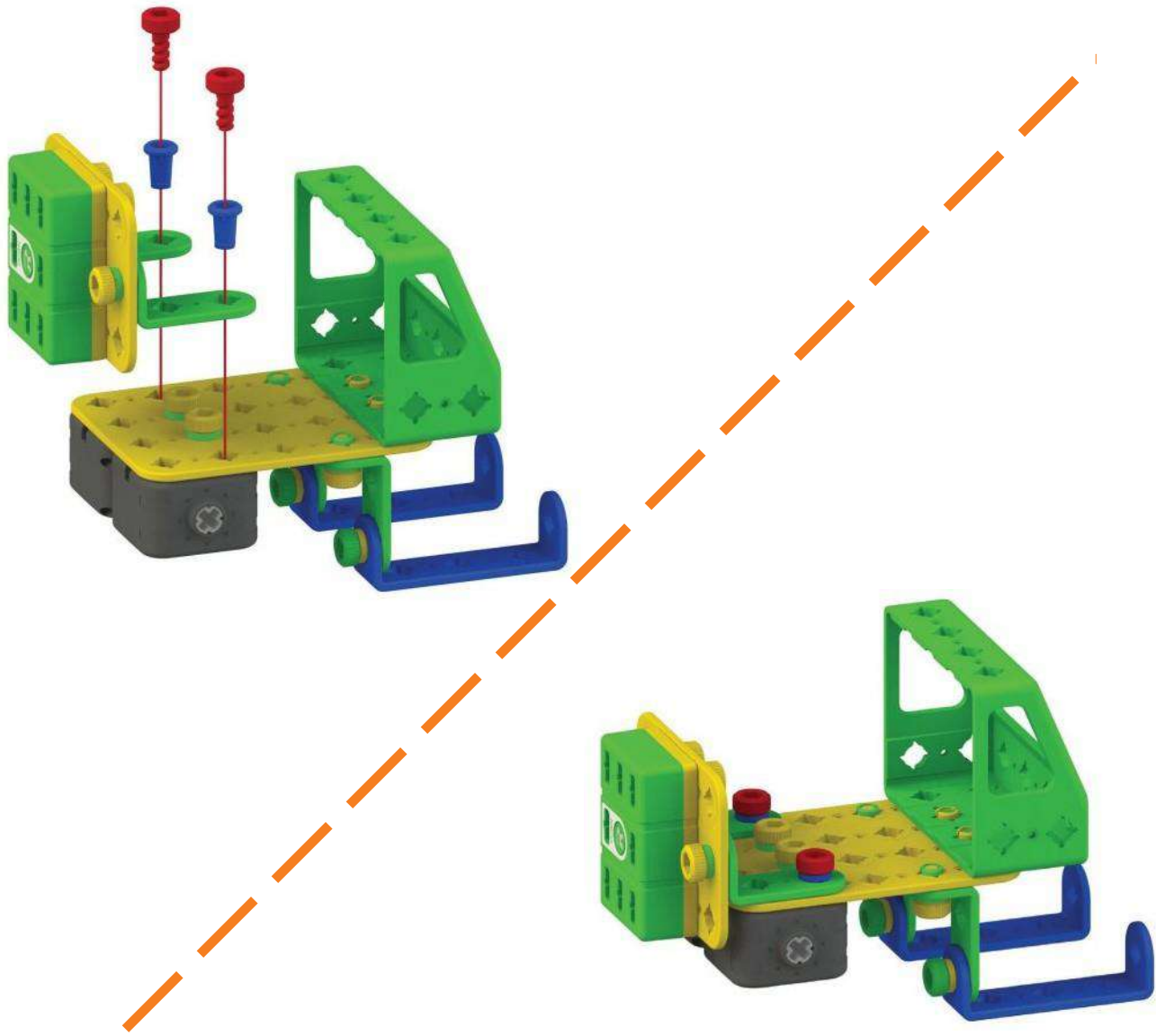

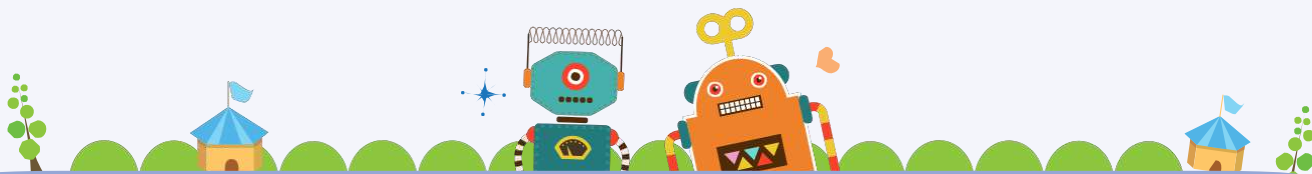

8

Детали



x1



x1



x2



x2

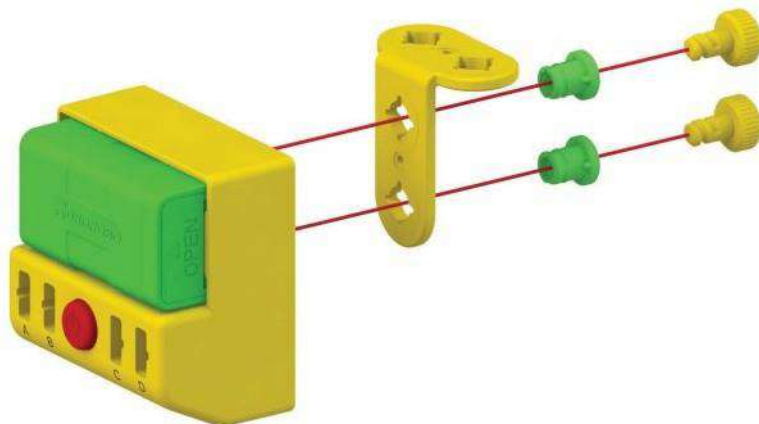



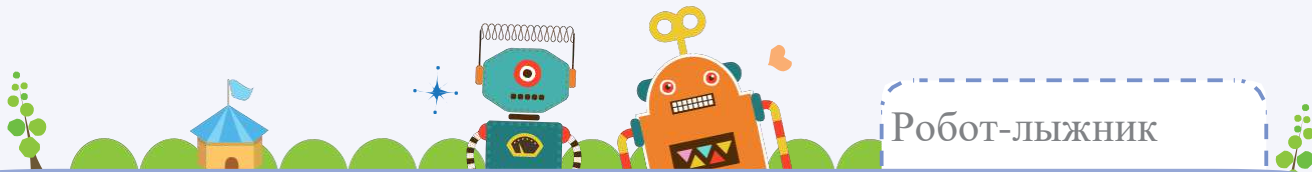

9

Детали



x2



x2



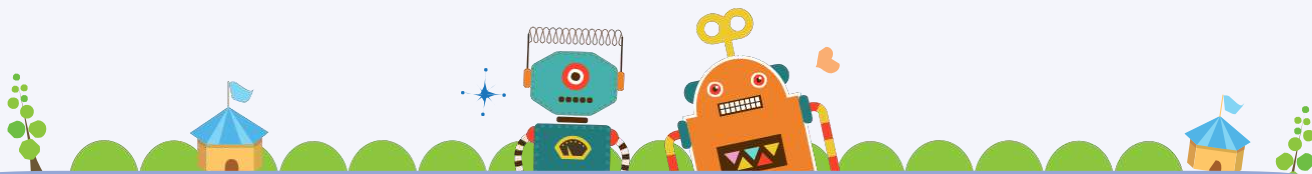

10

Детали



x2

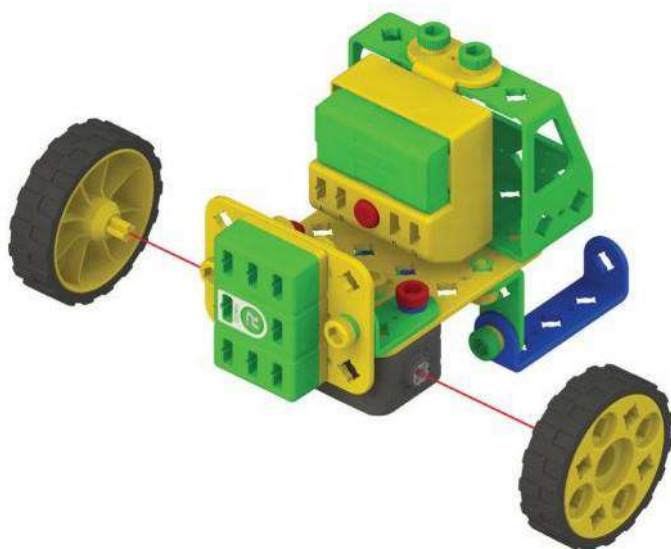

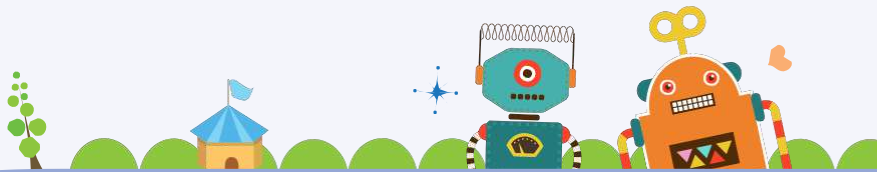

Детали



x2



x2



x2



x2

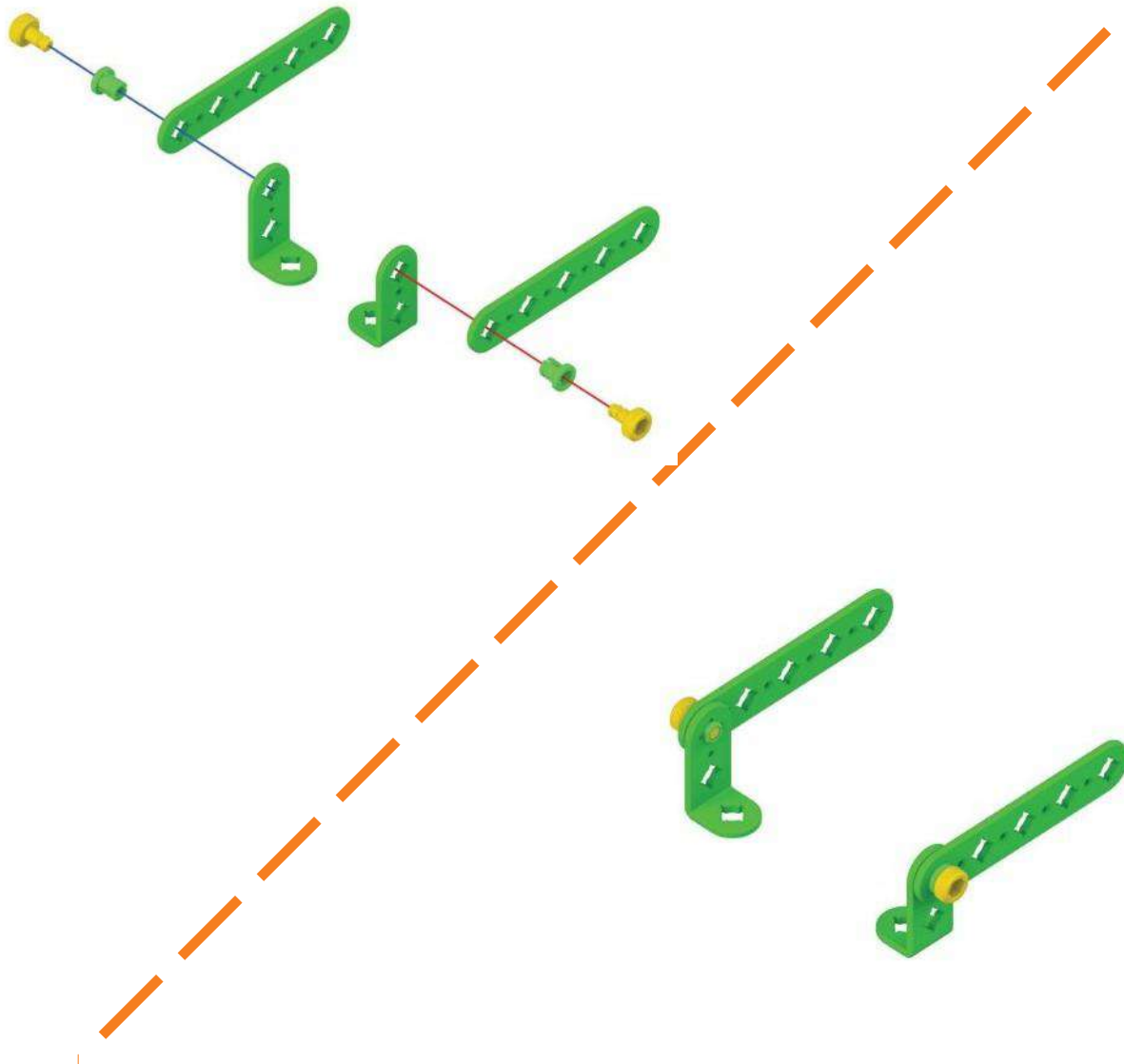

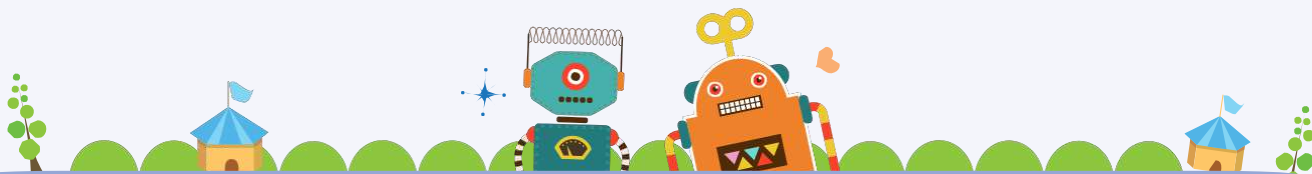

12

Детали



x2



x2

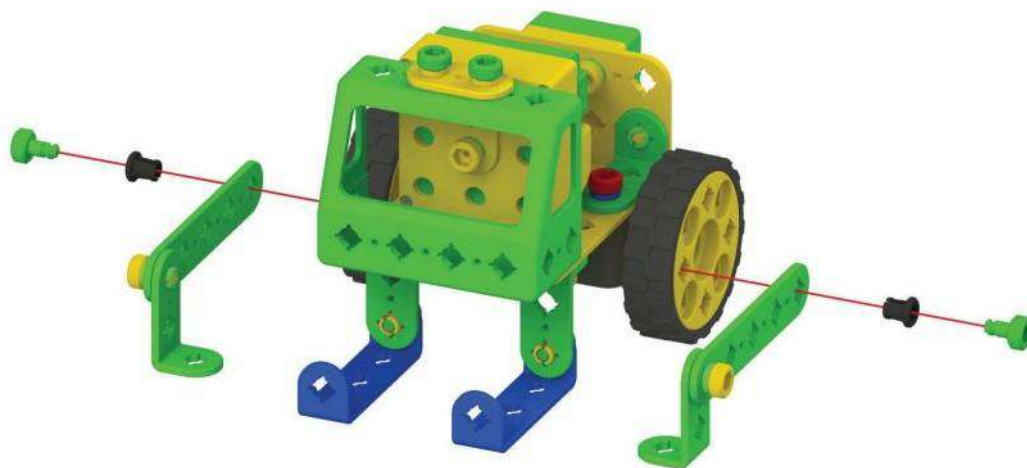

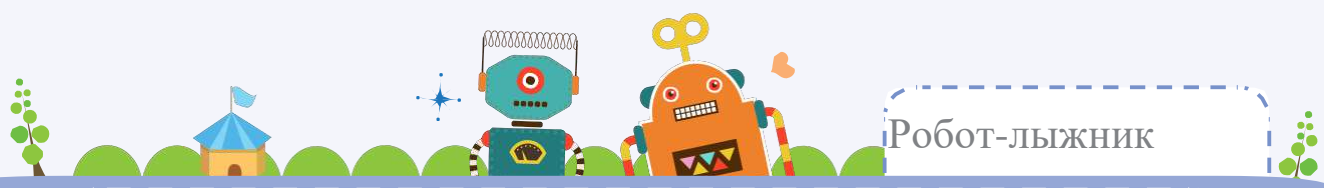

13 Детали

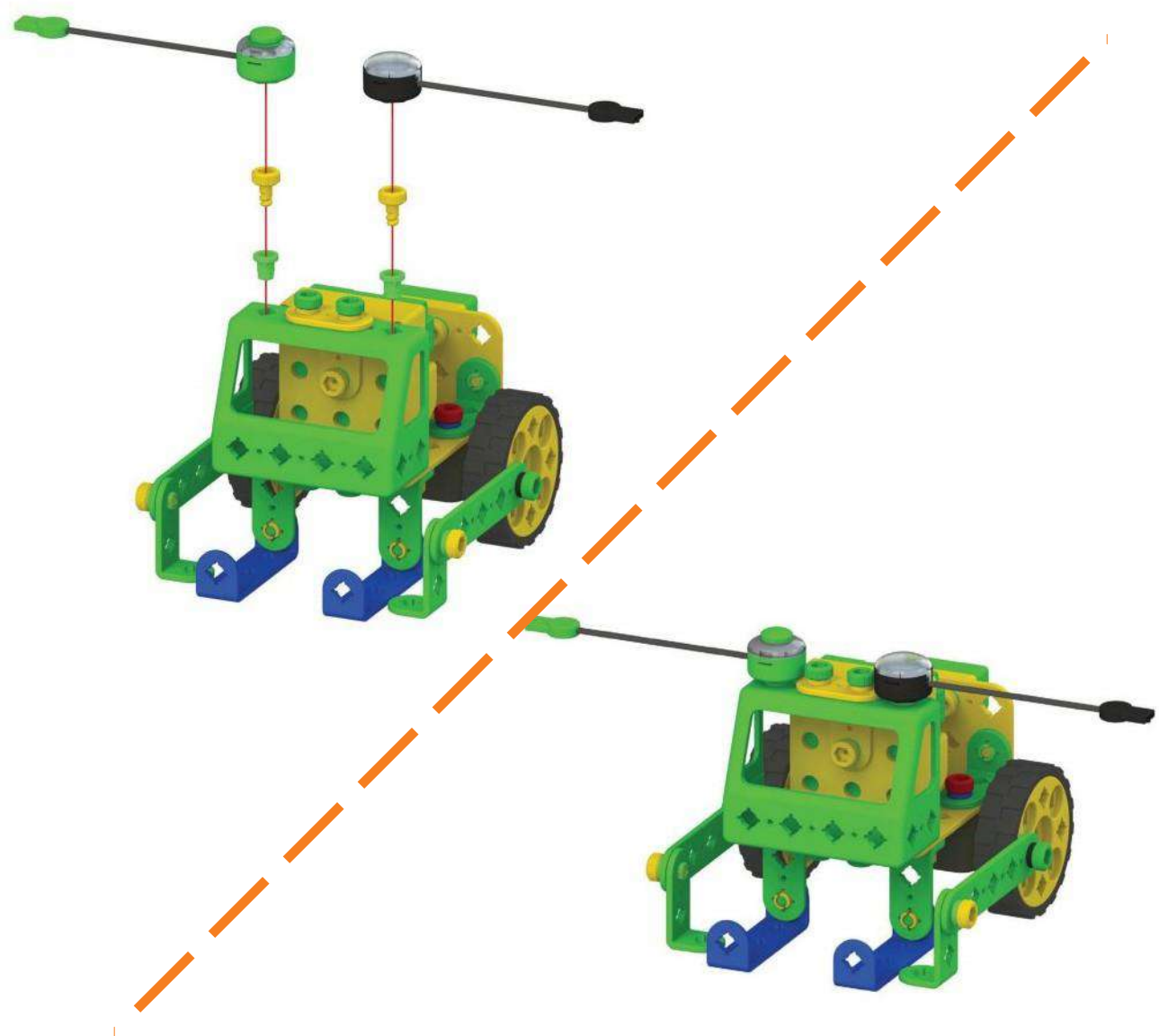

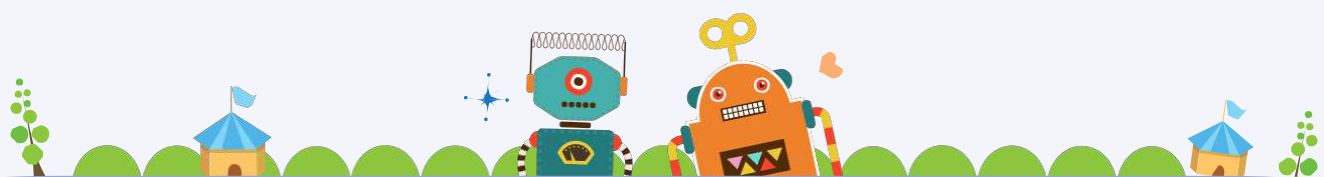

Левый  
электромотор  
Подключите к А

Правый  
электромотор  
Подключите к В

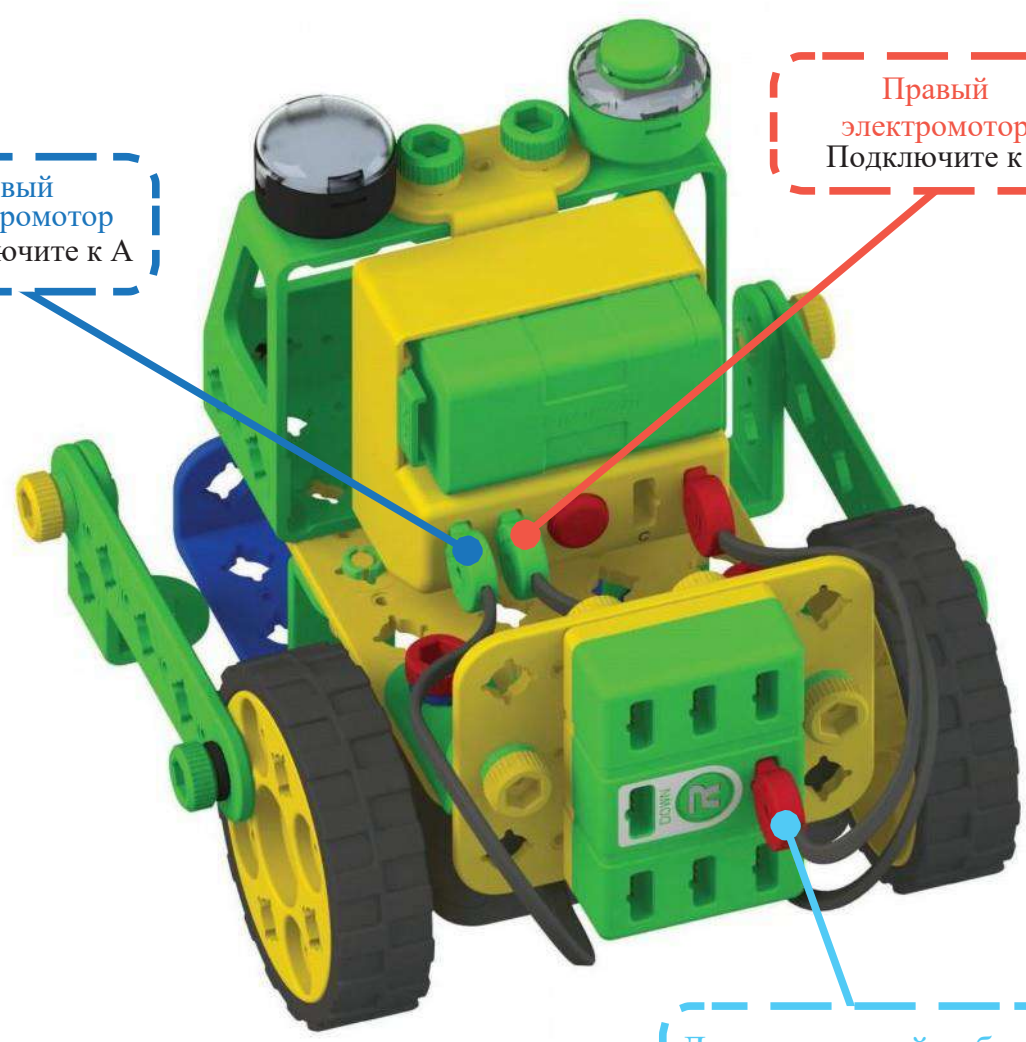

Двухсторонний кабель  
Подключите к порту D и ЦП

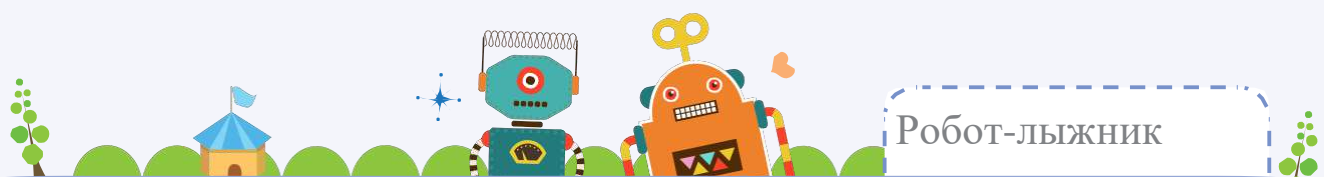

Робот-ЛЫЖНИК

Контактный датчик (G)  
Подключите к ЦП

Плата дистанционного приемника  
Подключите к ЦП

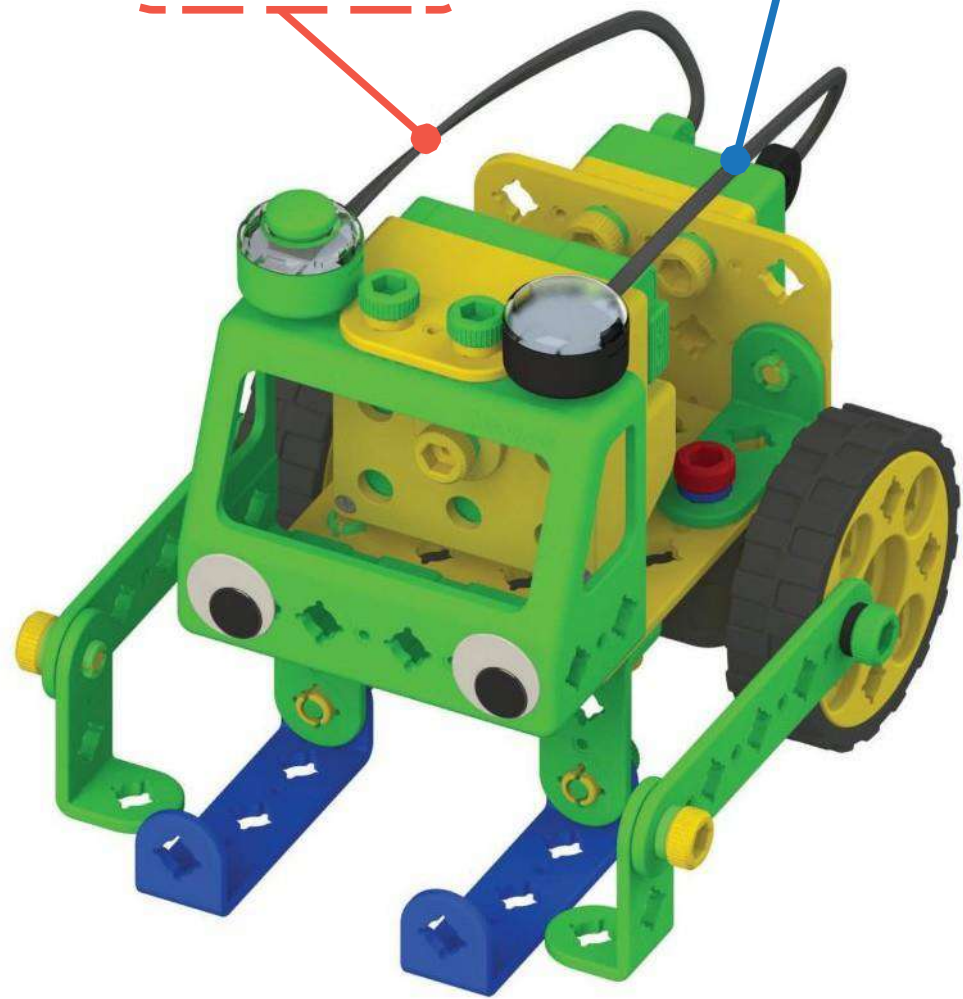



Запрограммируем движение робота лыжника на программной плате.



Управляйте роботом-лыжником с помощью устройства дистанционного управления



2-й

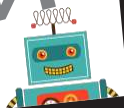

Сыграем с роботом-хоккеистом!

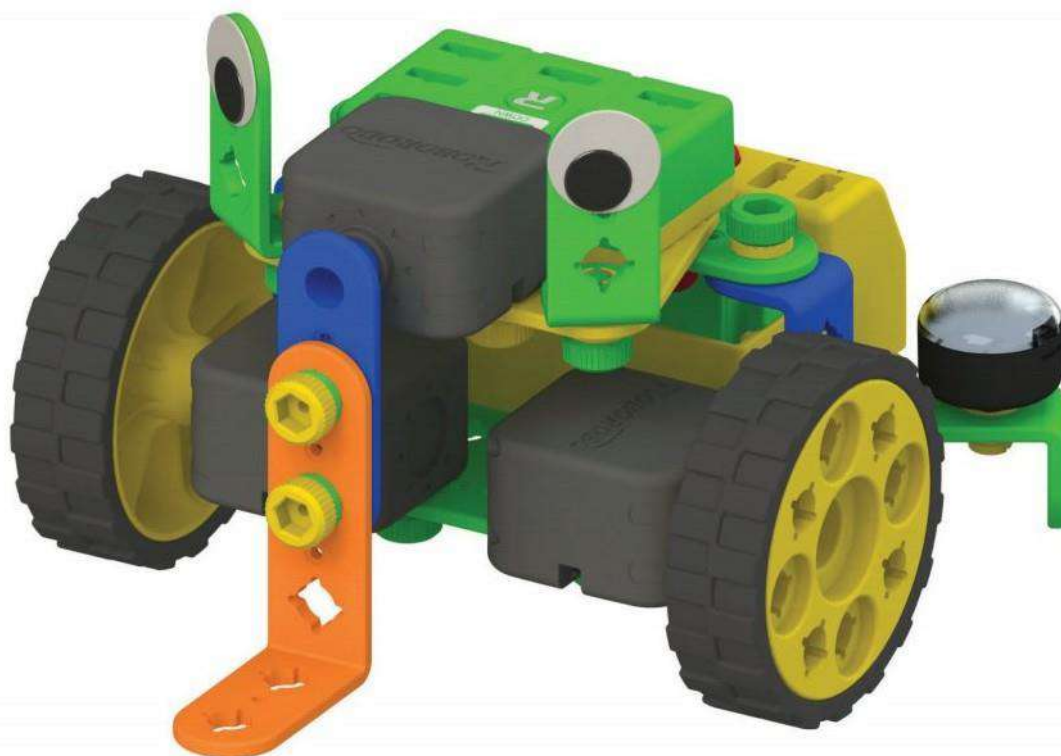

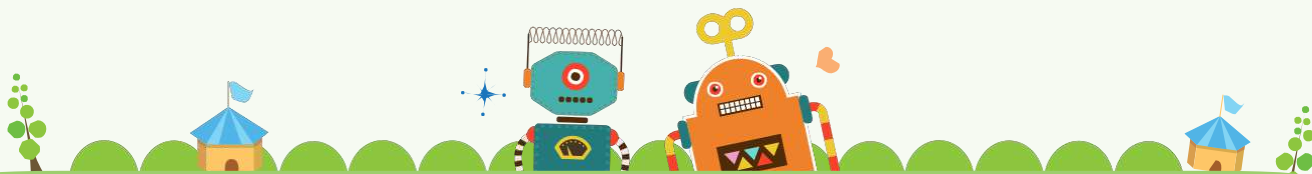

Детали



x2



x1



x4



x4

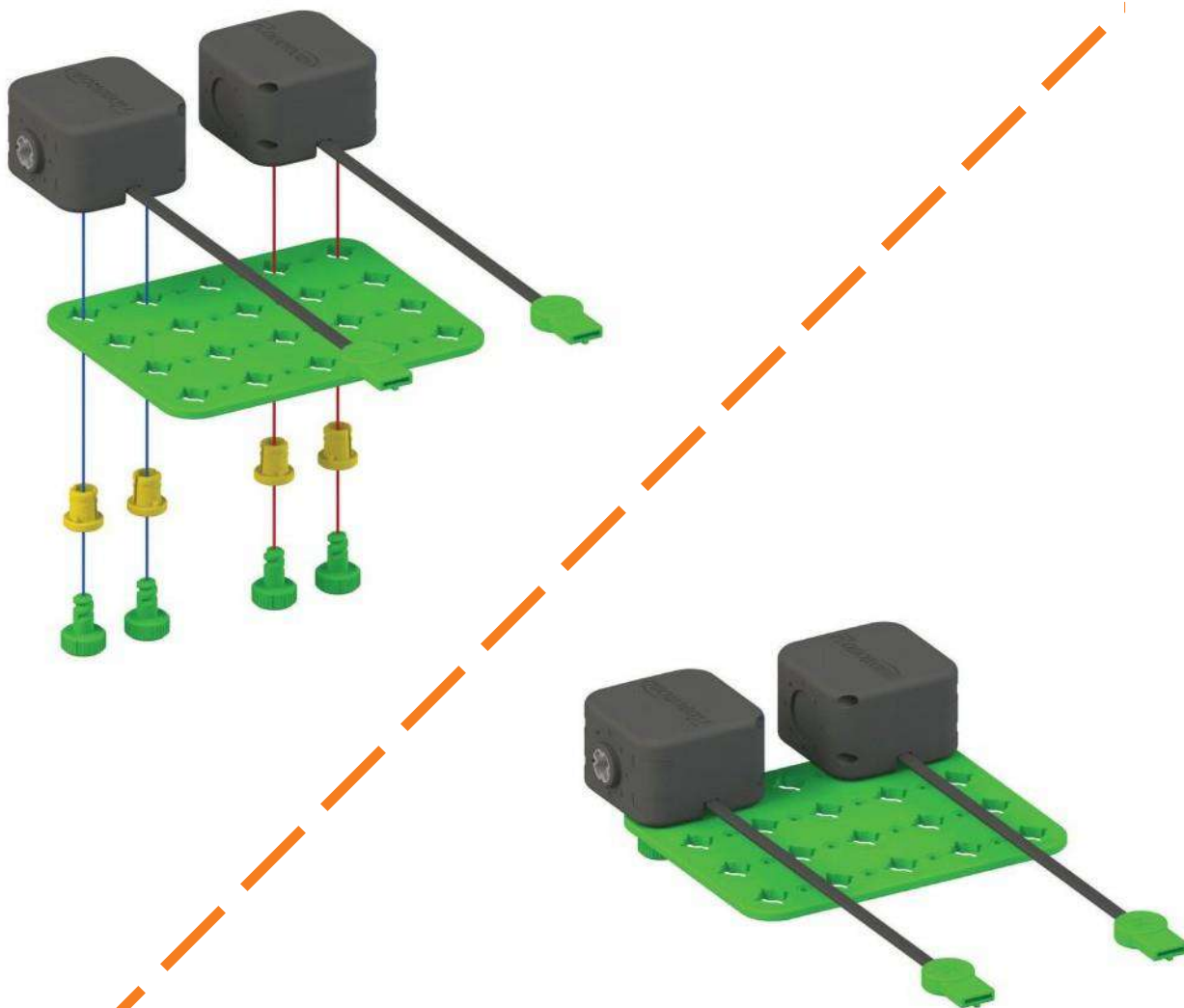

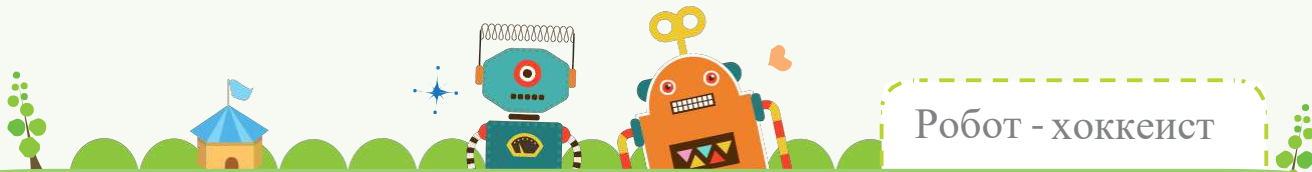

2

Детали



x2



x2



x4



x4

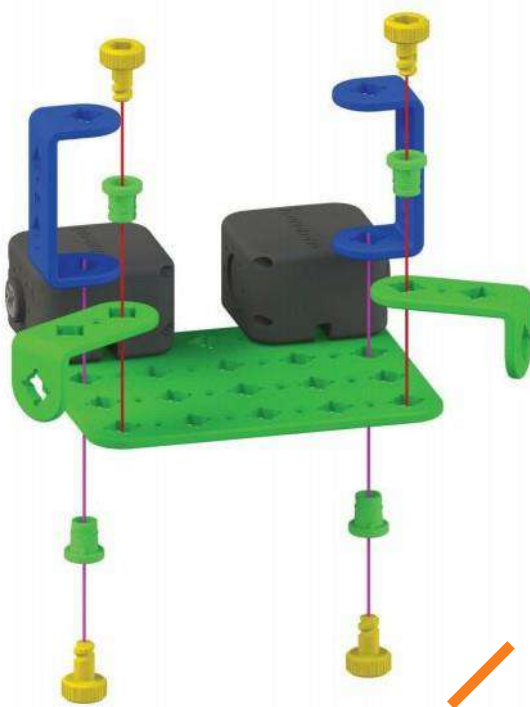

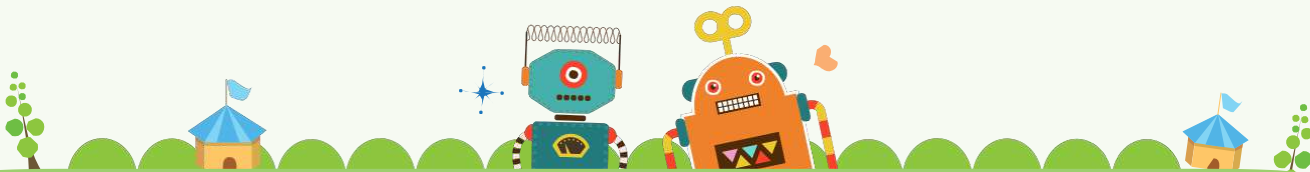

3

Детали



x1



x2



x2

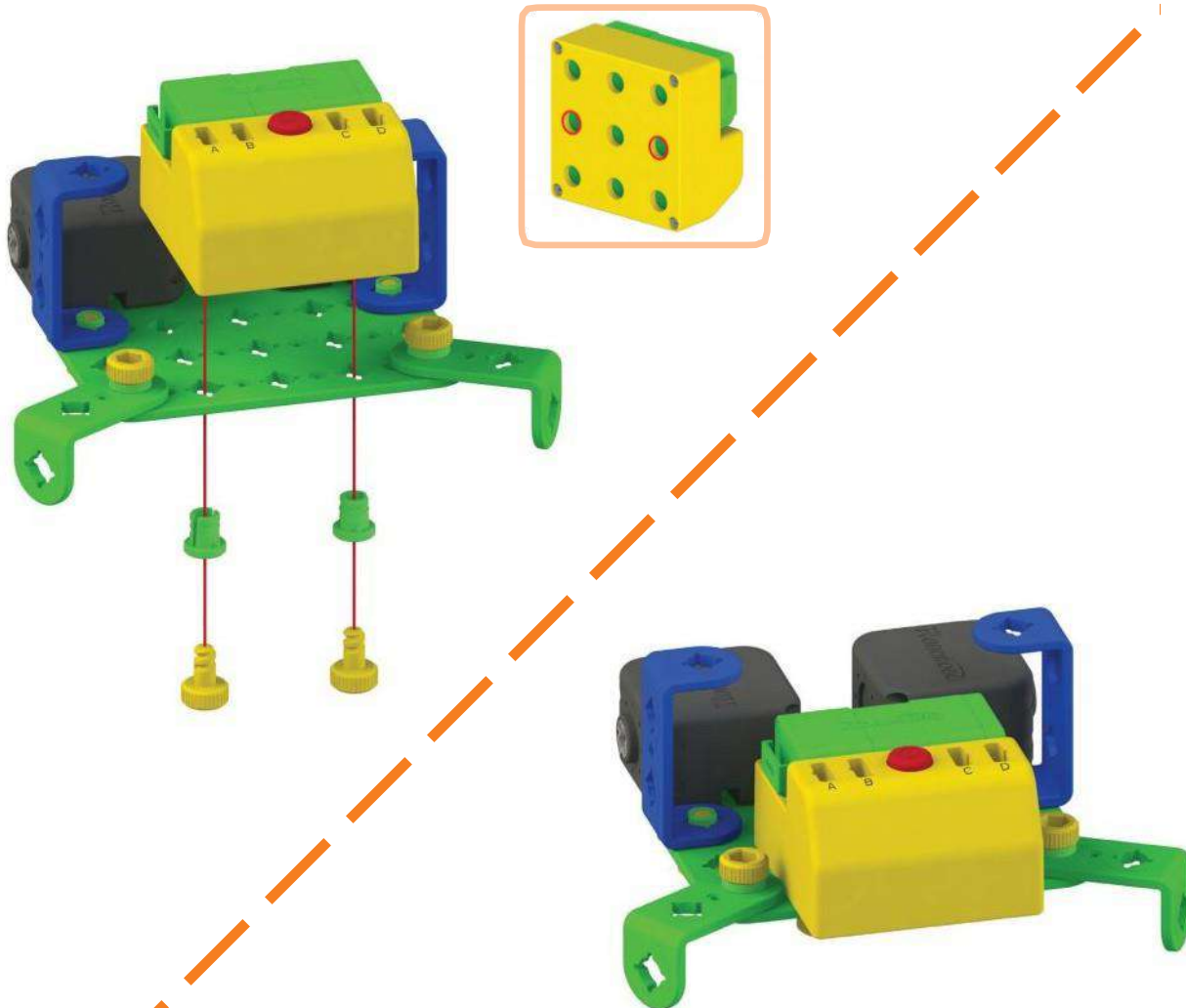

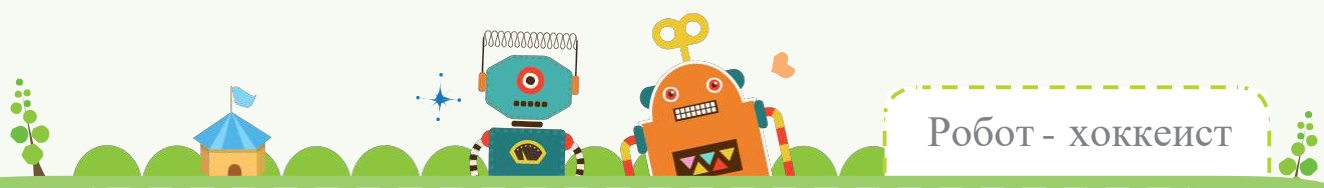

4

Детали



x1



x1



x1



x2



x2

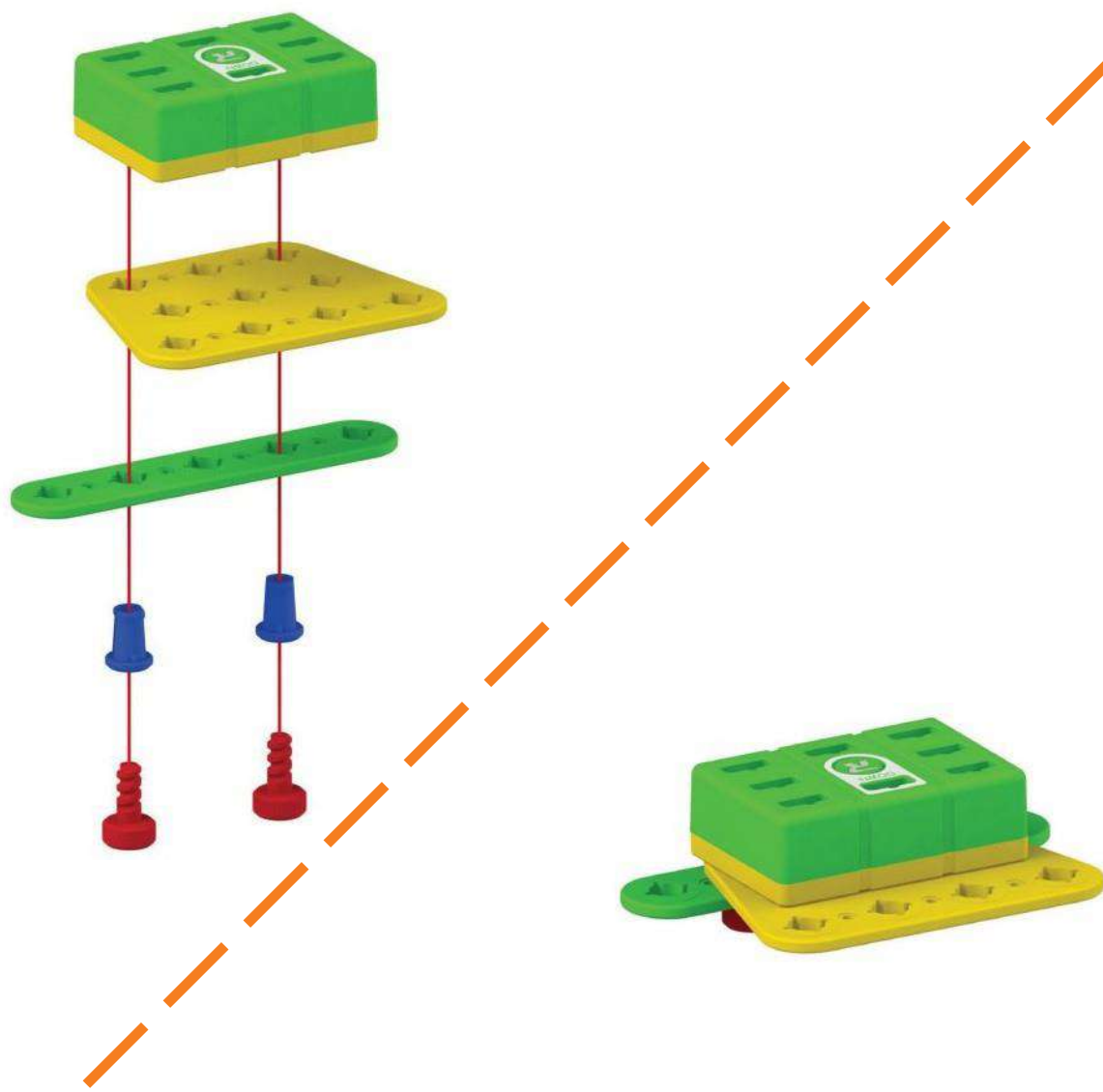

5

Детали



x1



x2



x2

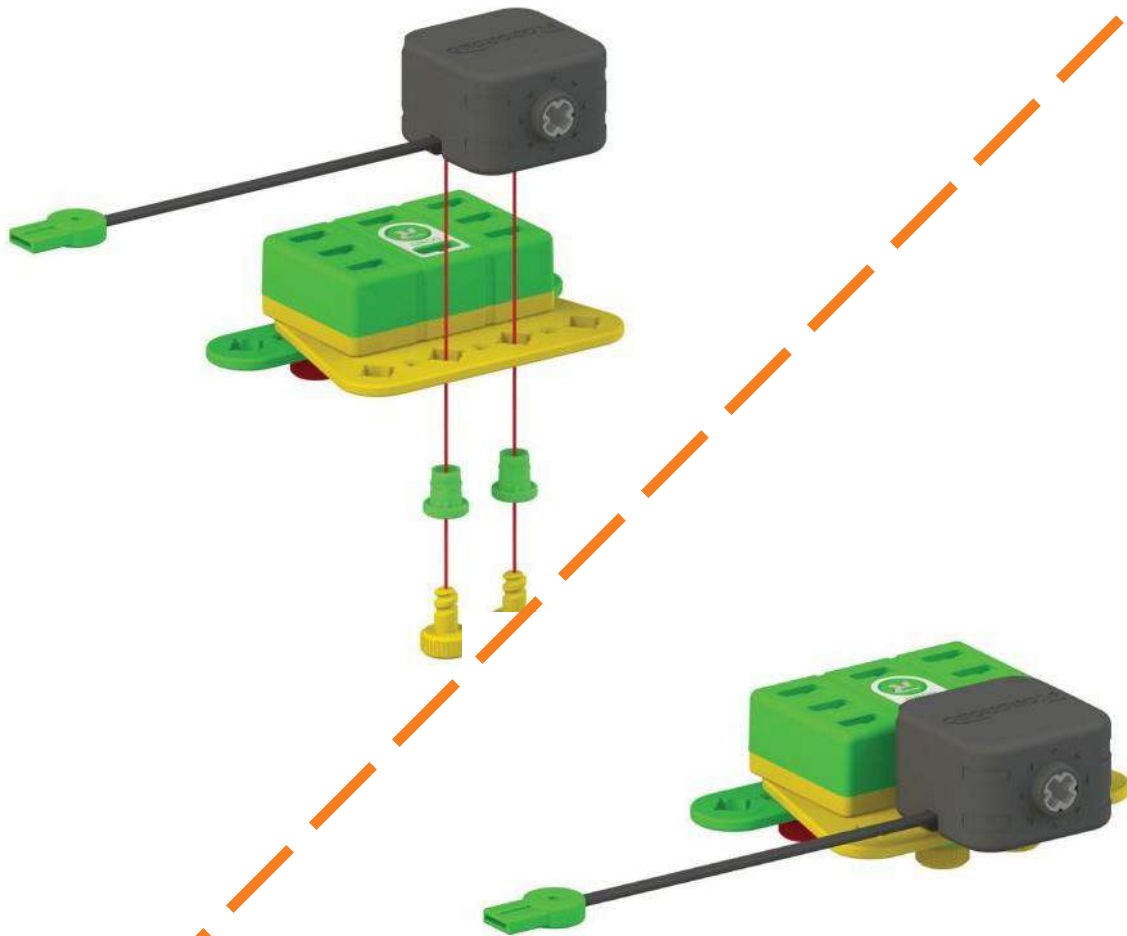

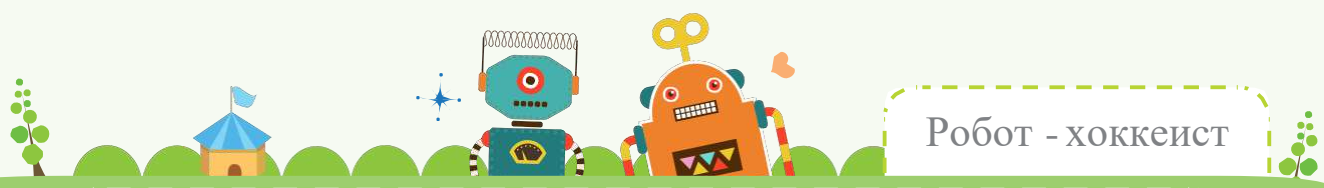

6

Детали



x2



x2



x2



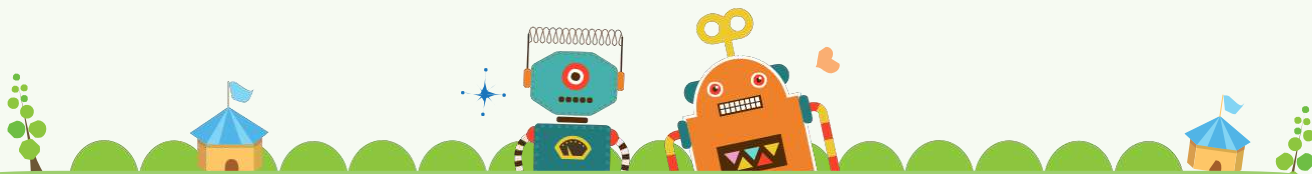

Детали



x1



x1



x2



x2

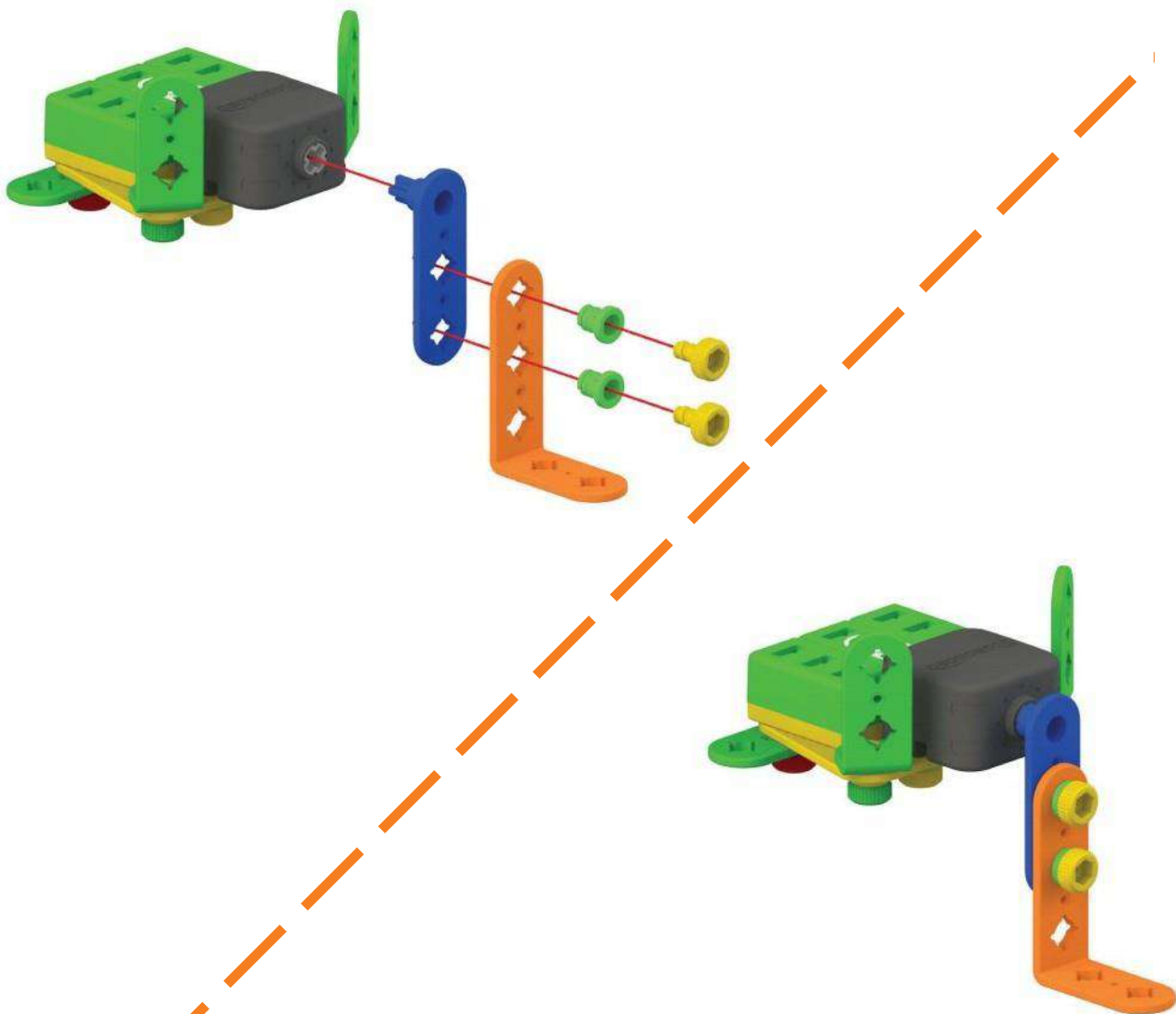



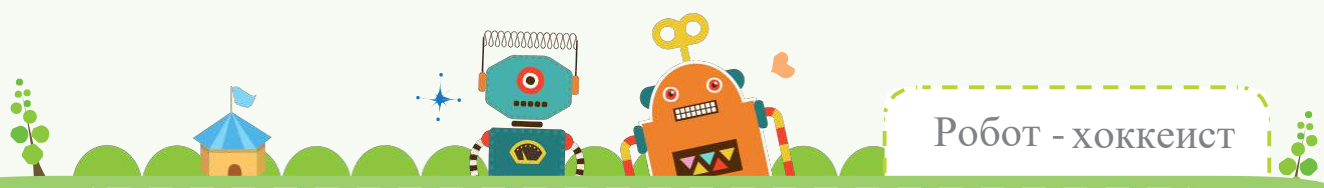

8

Детали



x2



x2

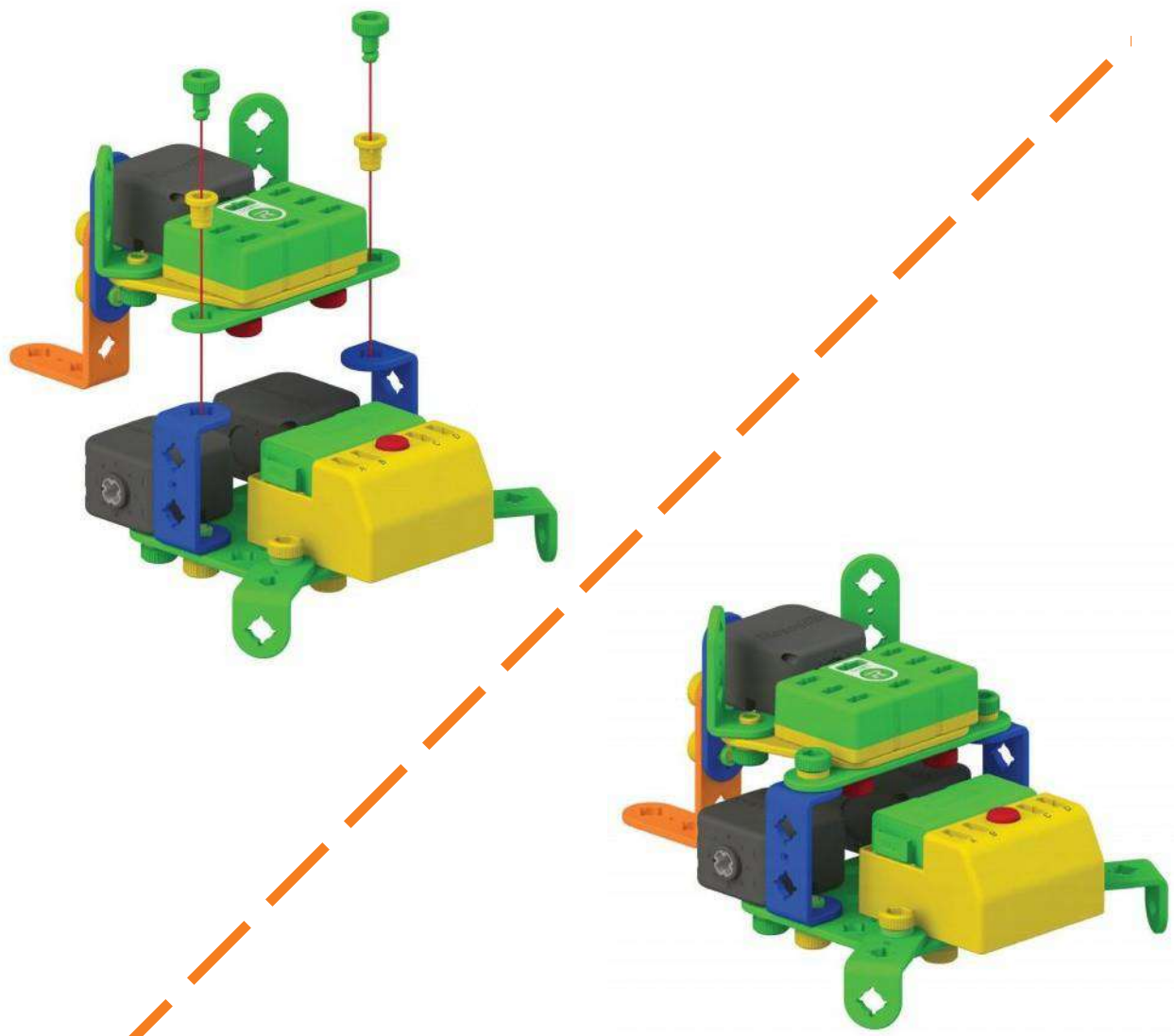

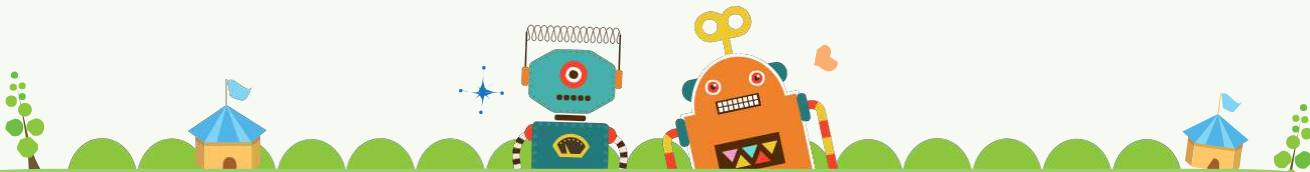

9

Детали



x2

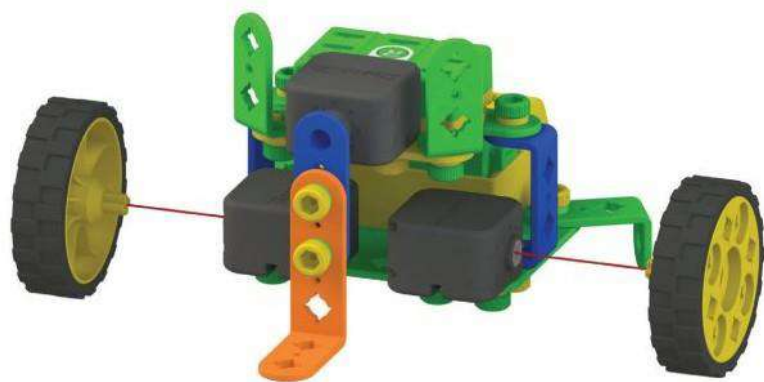

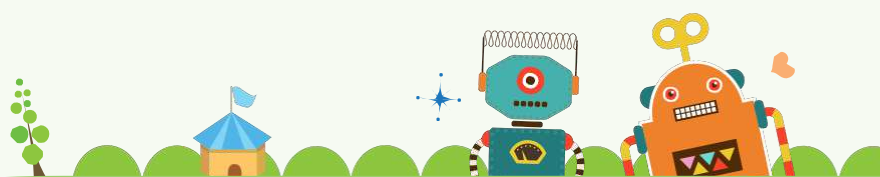

10

Детали



x1



x1



x2



x2



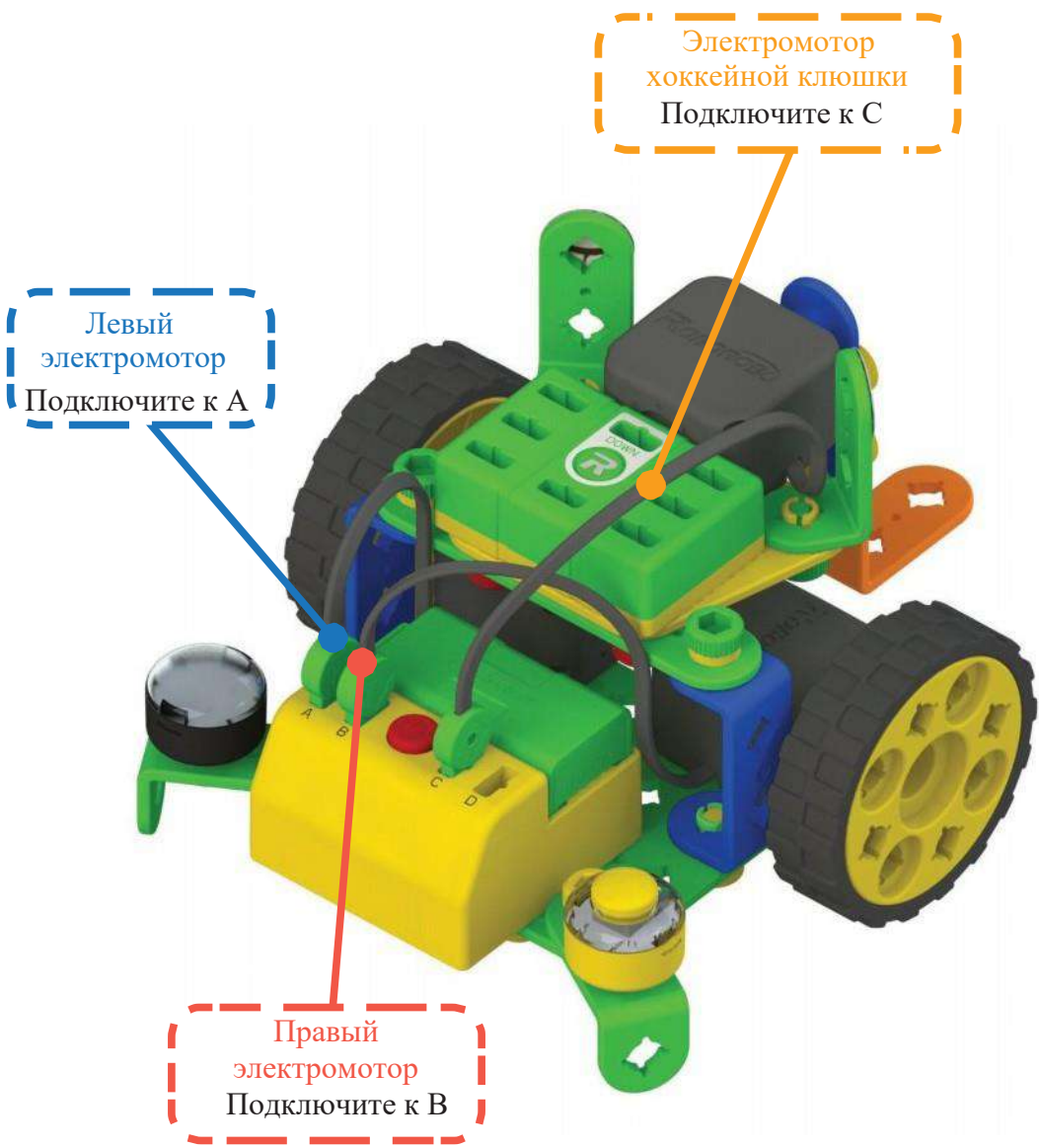
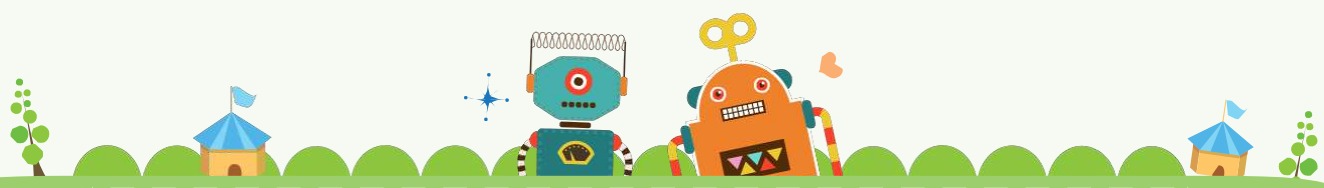

Двухсторонний кабель  
Подключите к порту D и ЦП

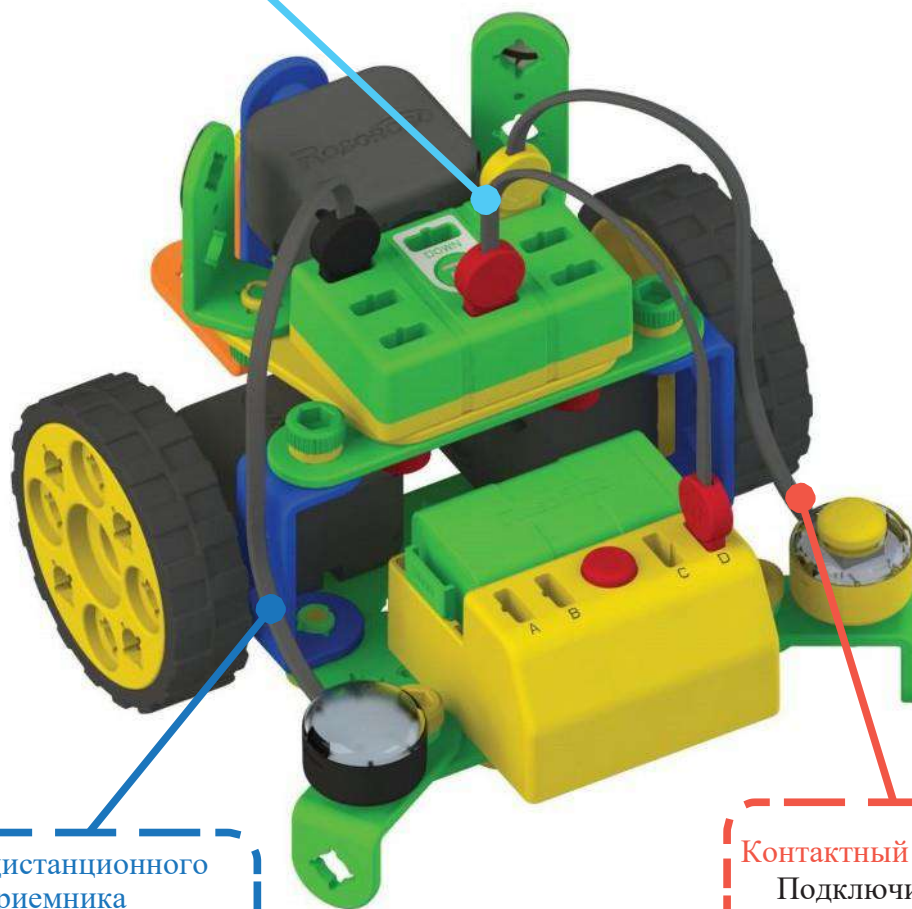

Плата дистанционного  
приемника  
Подключите к ЦП

Контактный датчик (Y)  
Подключите к ЦП



Запрограммируем движение робота хоккеиста на программной плате.



Управляйте роботом-хоккеистом с помощью устройства дистанционного управления

3-й



## Сыграем с Рудольфом



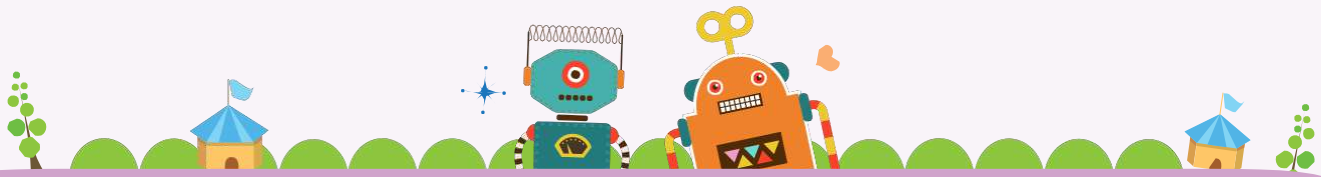

Детали



x2



x1



x4



x4

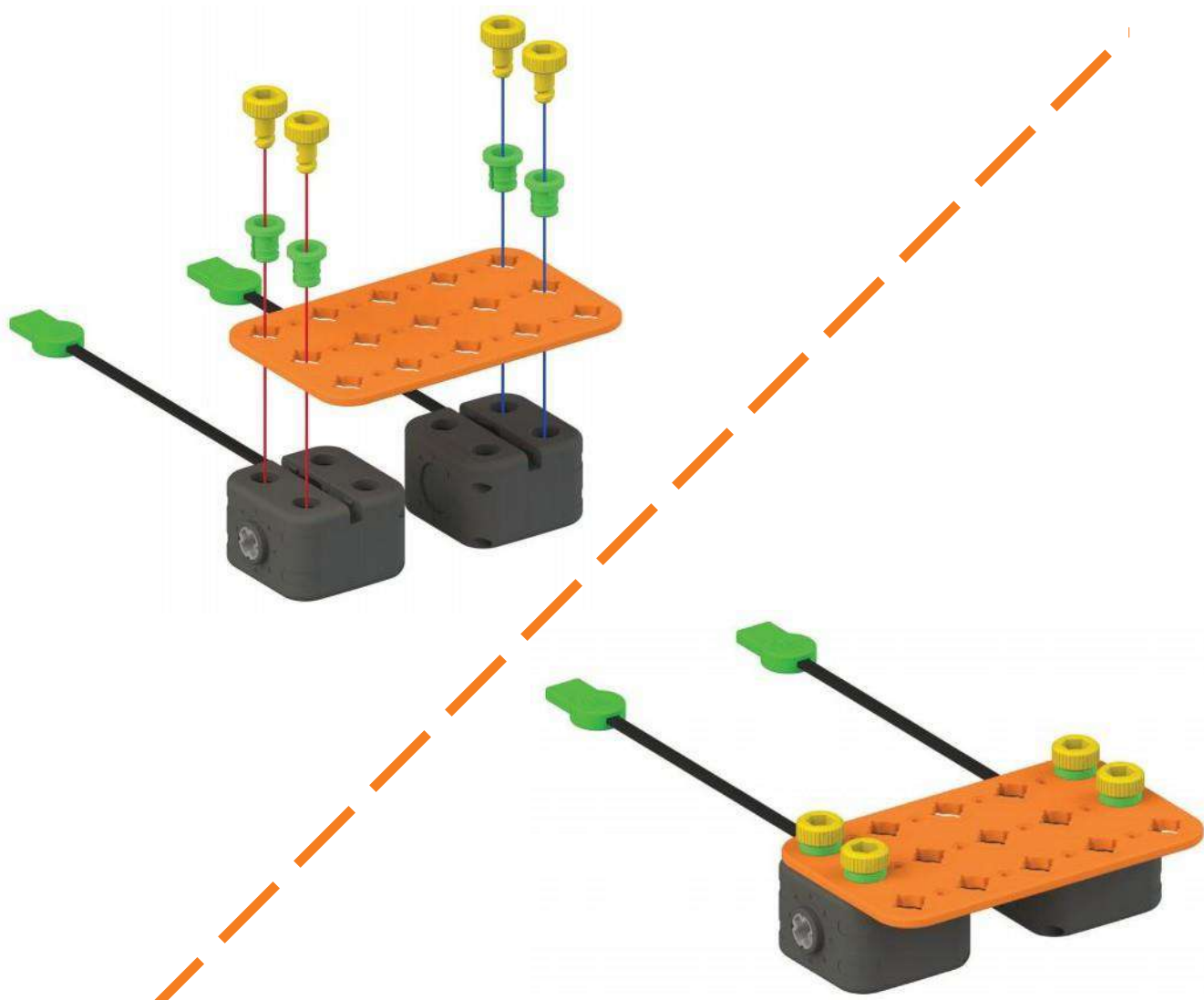



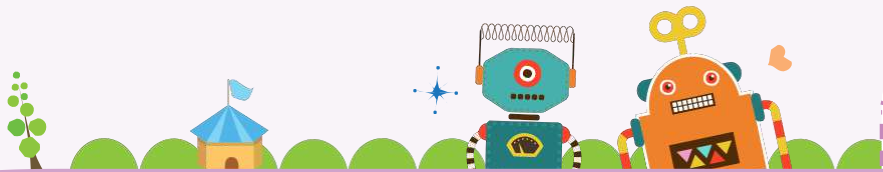

2

Детали



x3



x2



x1



x1



x2

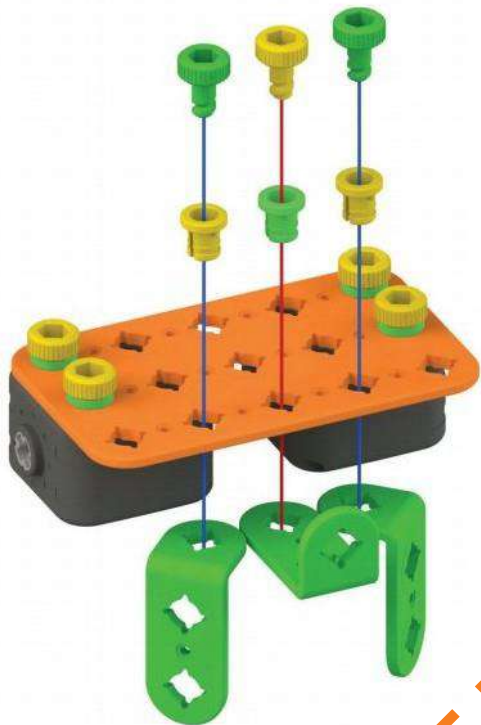

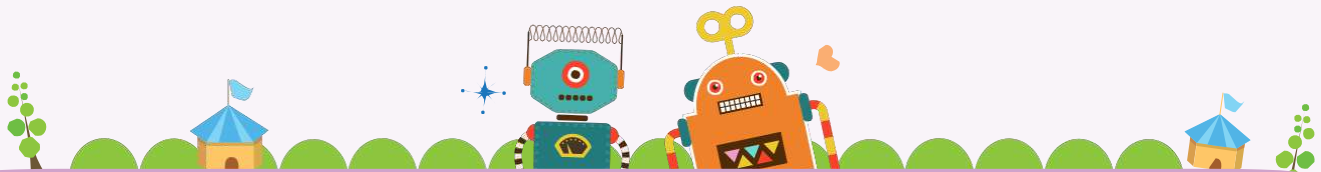

3

Детали



x2



x1



x2



x1



x2



x1

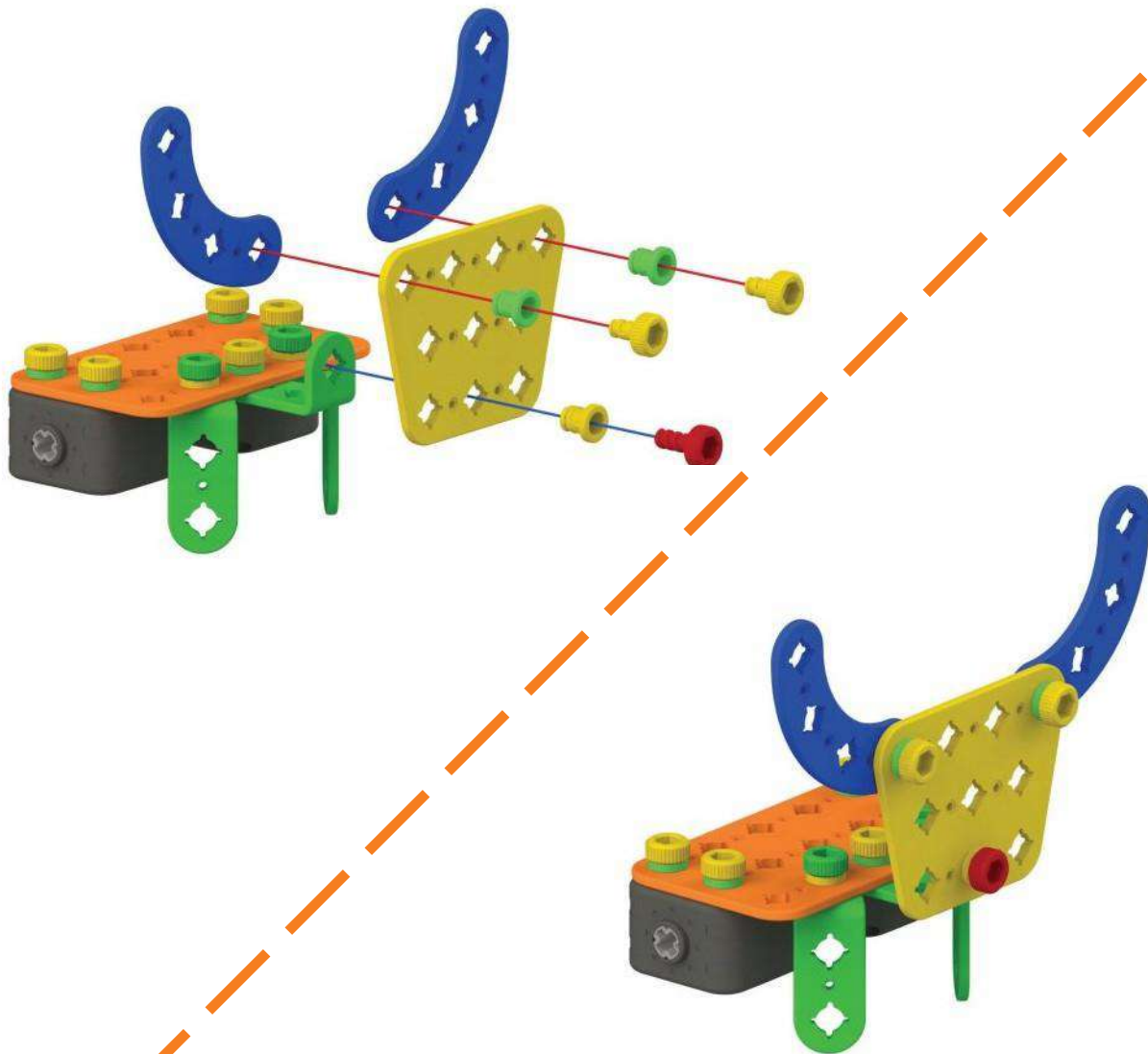

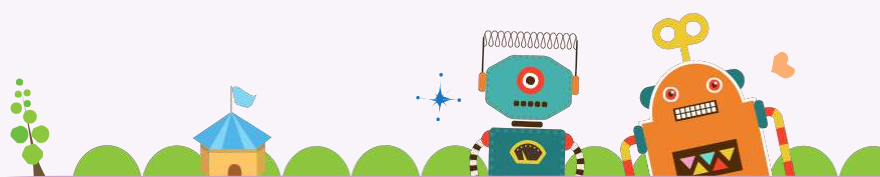

4

Детали



x1



x2



x2



x2

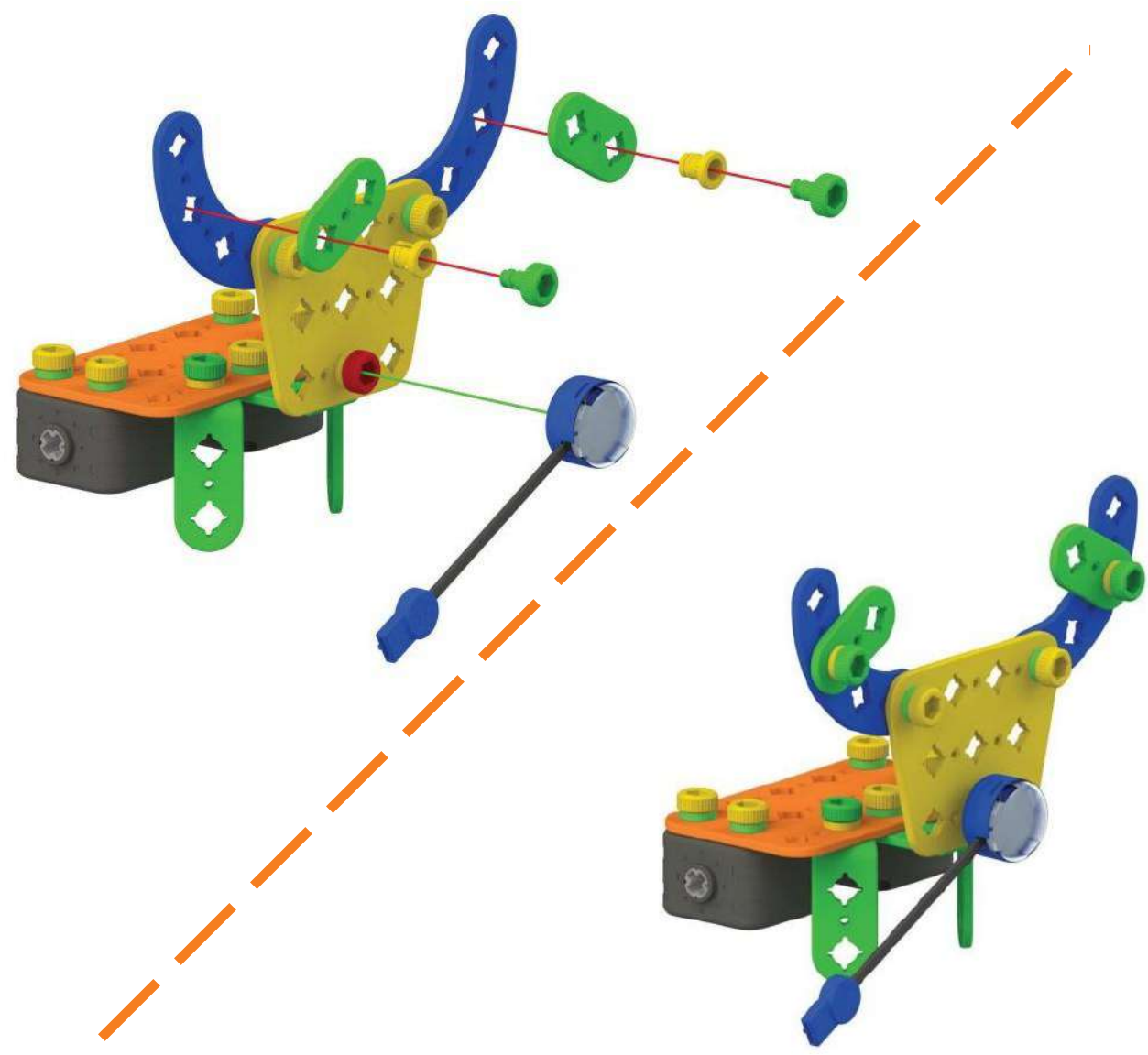

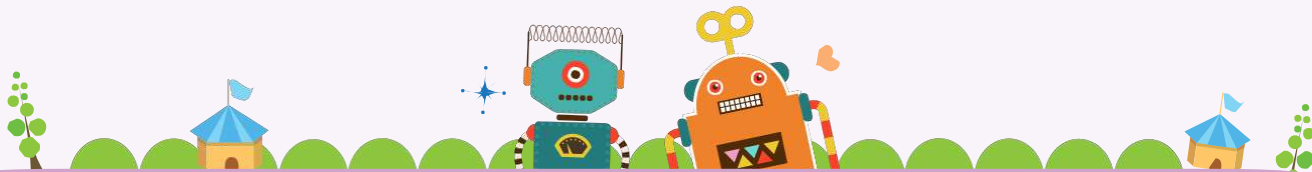

5

Детали



x1



x2



x2

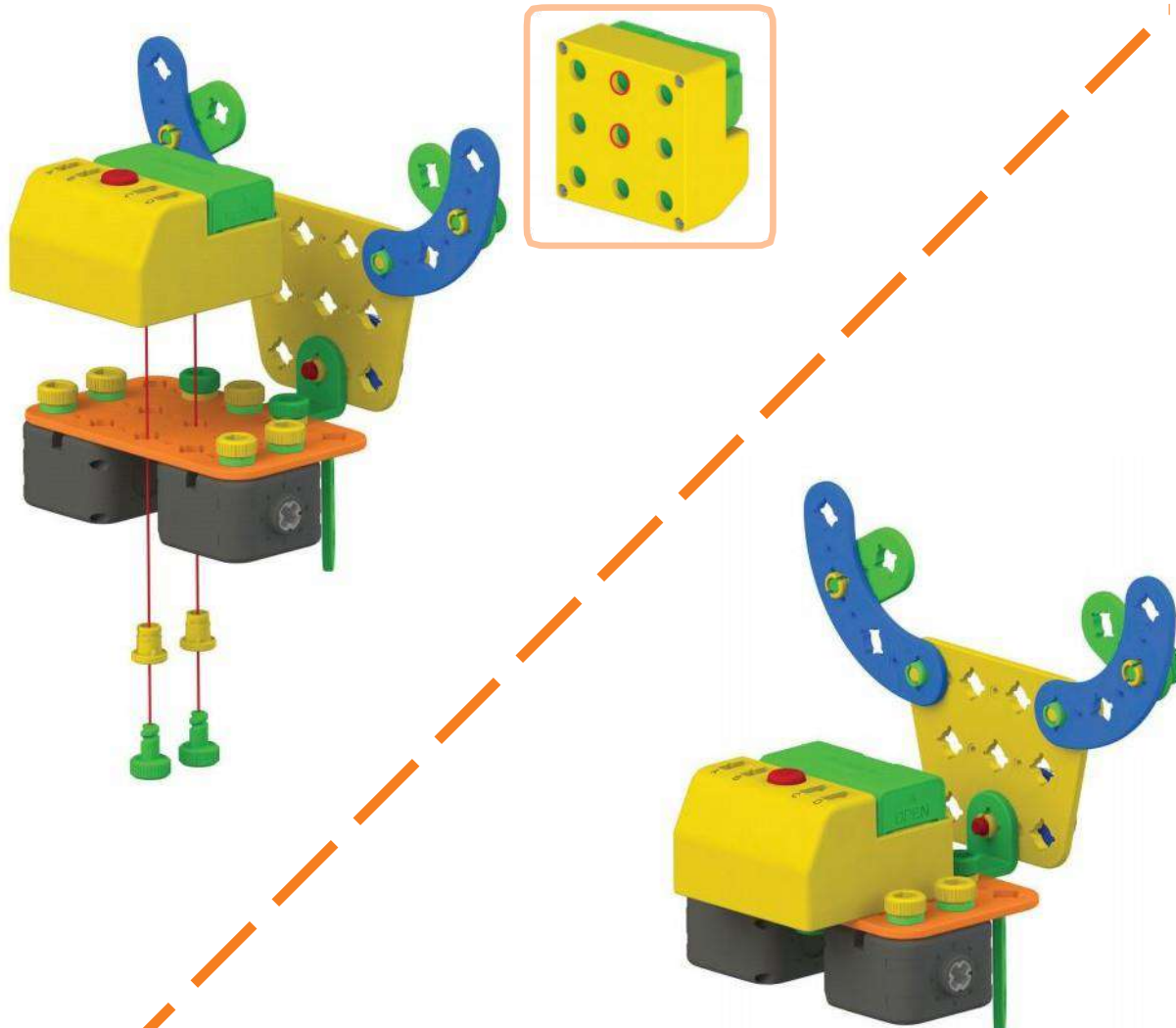

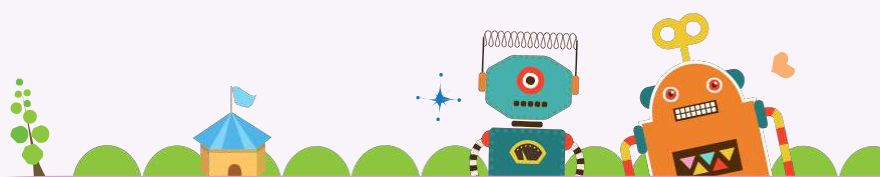

6

Детали



x1



x3



x2



x1



x1



x2

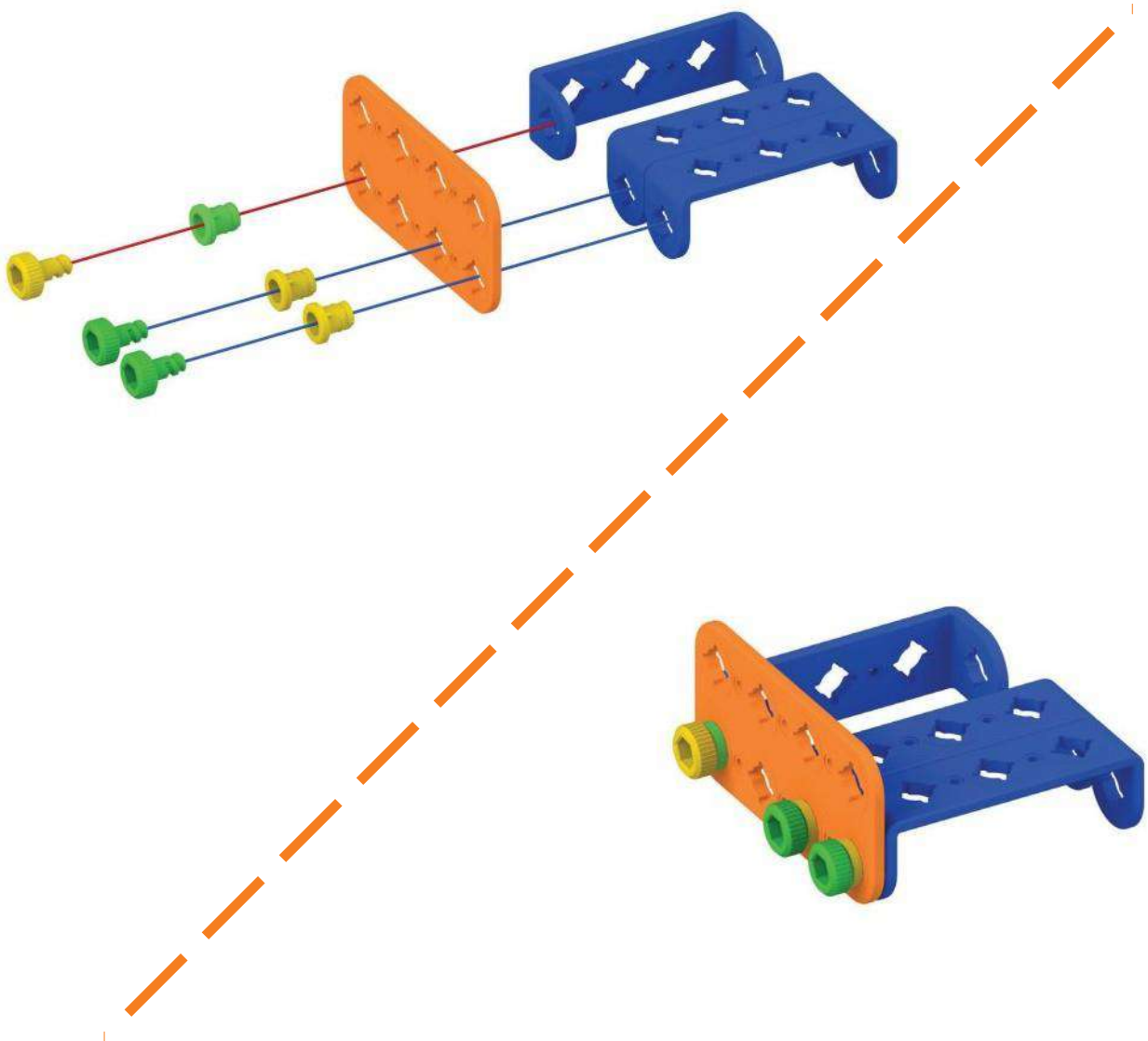

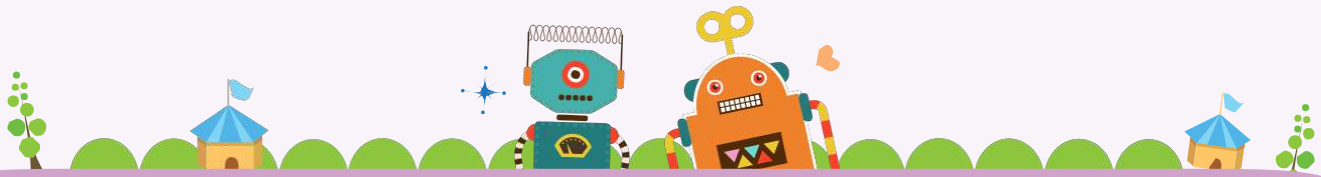

Детали



x1



x2



x1



x1



x2

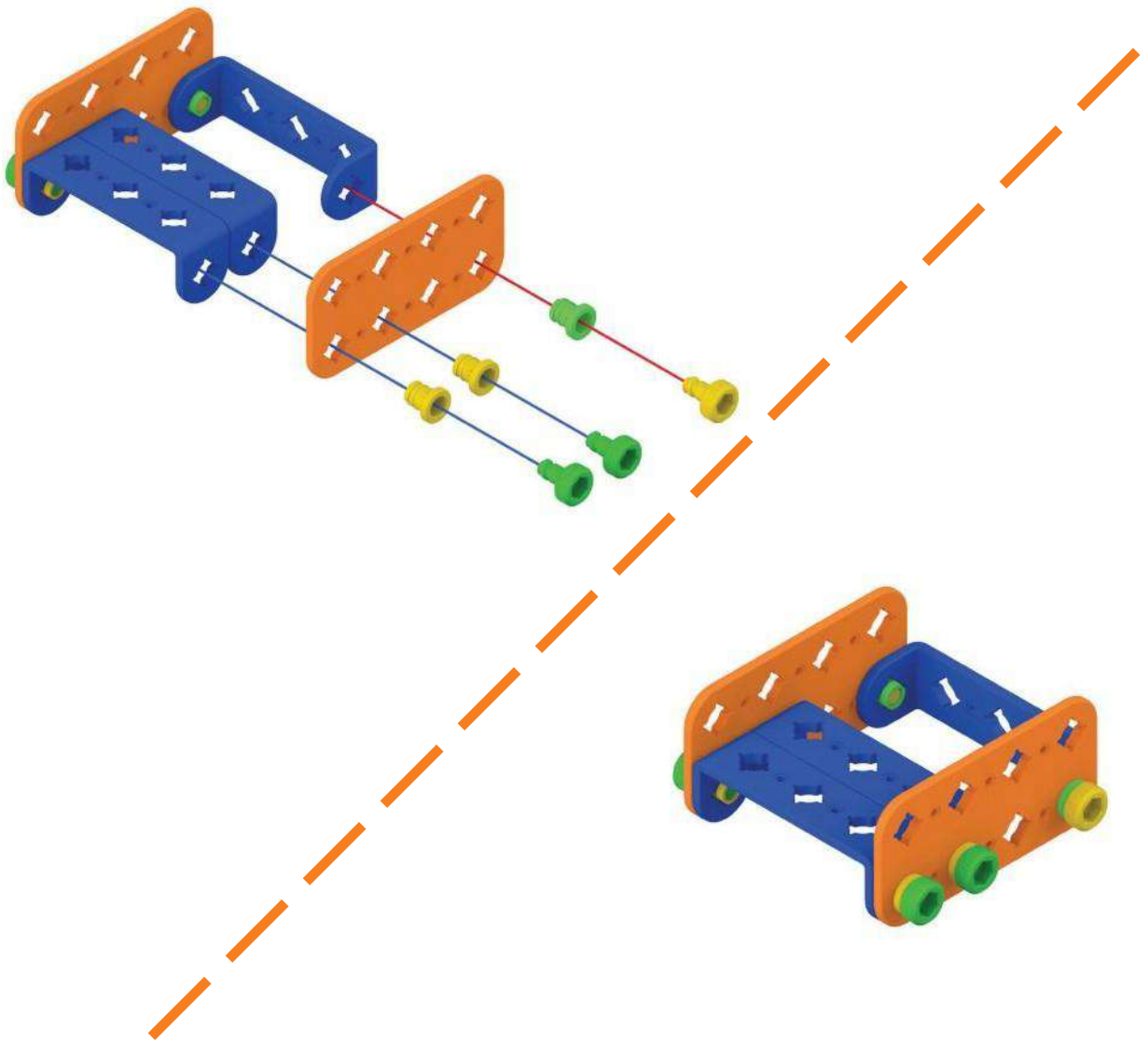

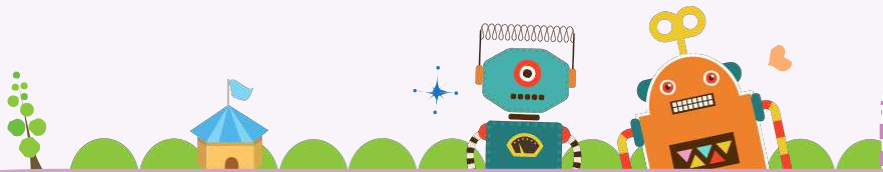

8

Детали



x1



x2



x4



x4

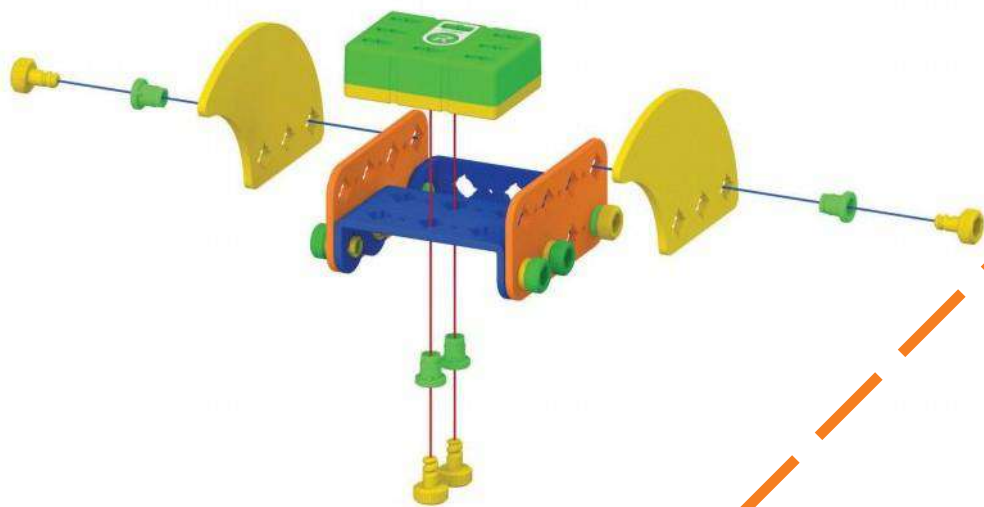

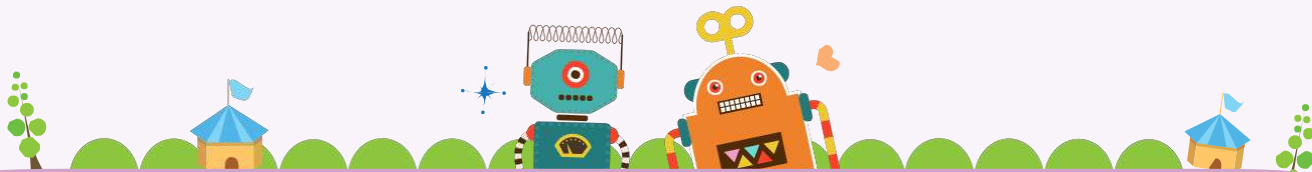

9

Детали



x1



x1



x1

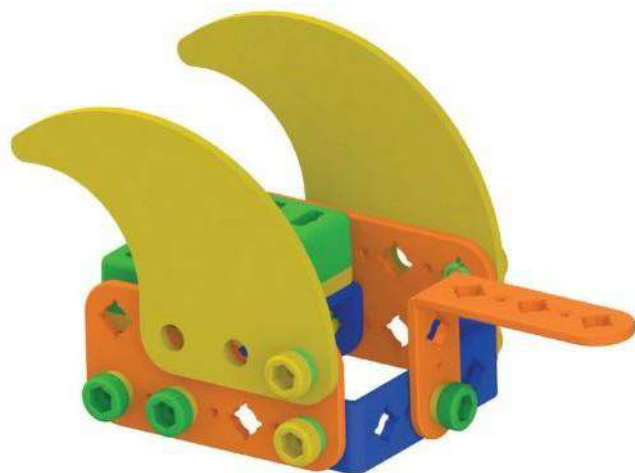
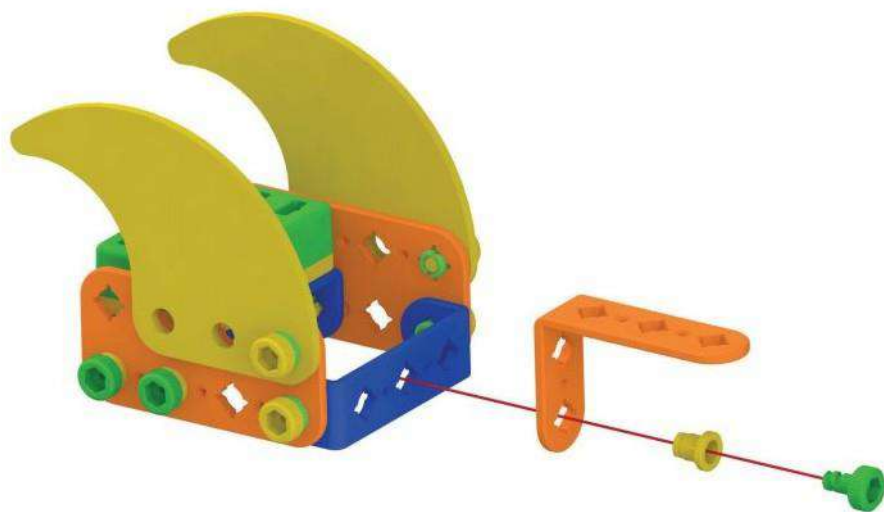



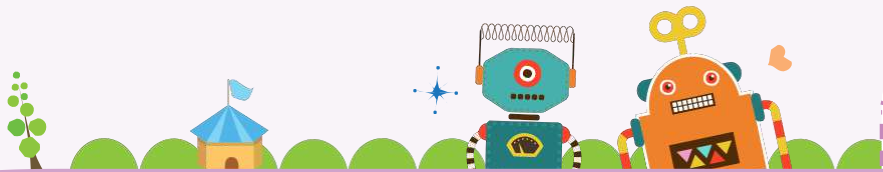

10

Детали



x1



x1



x1



x1



x1

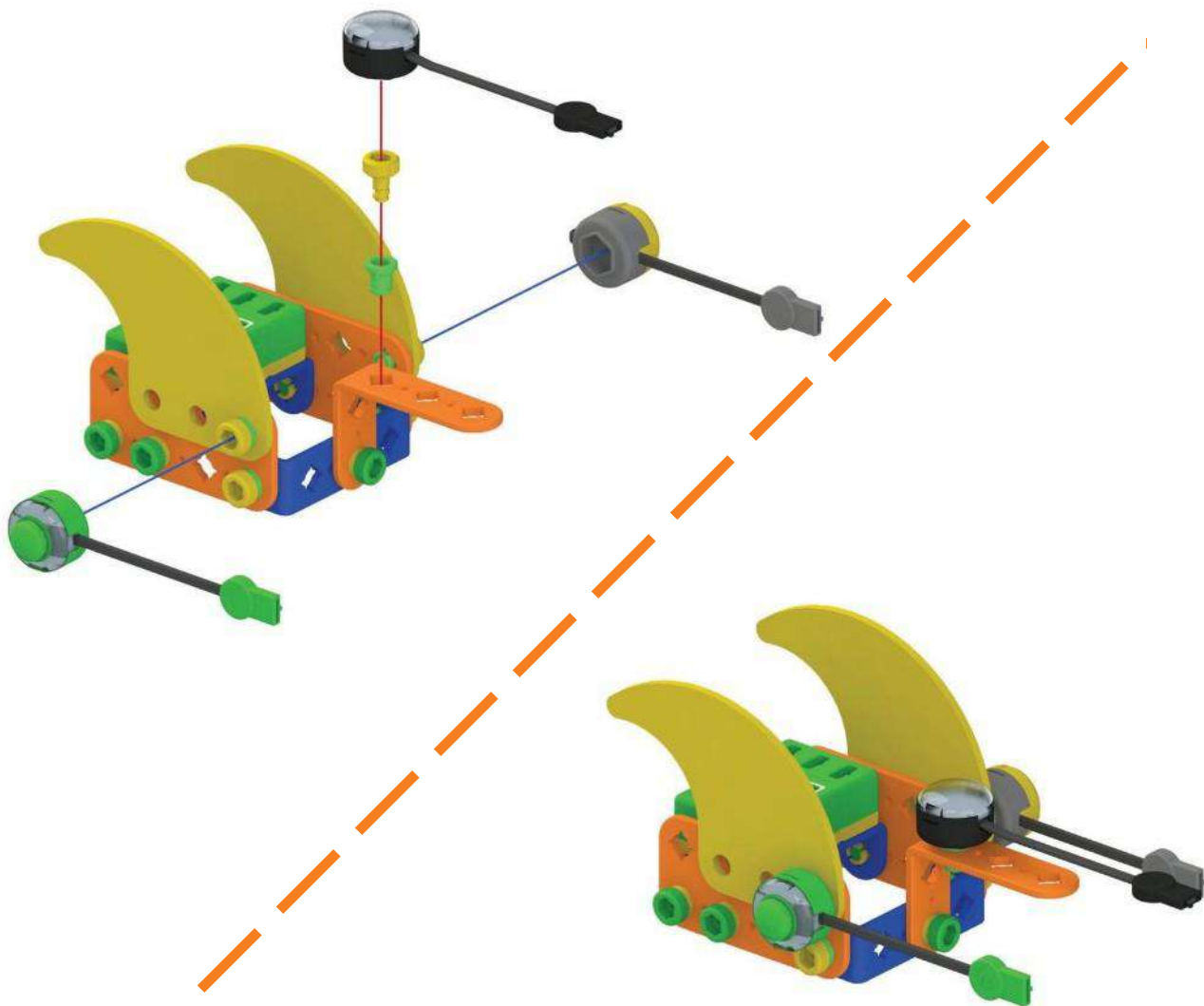

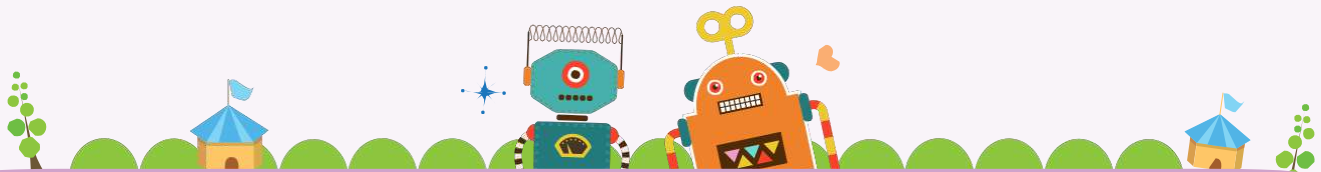

Детали



x1



x1

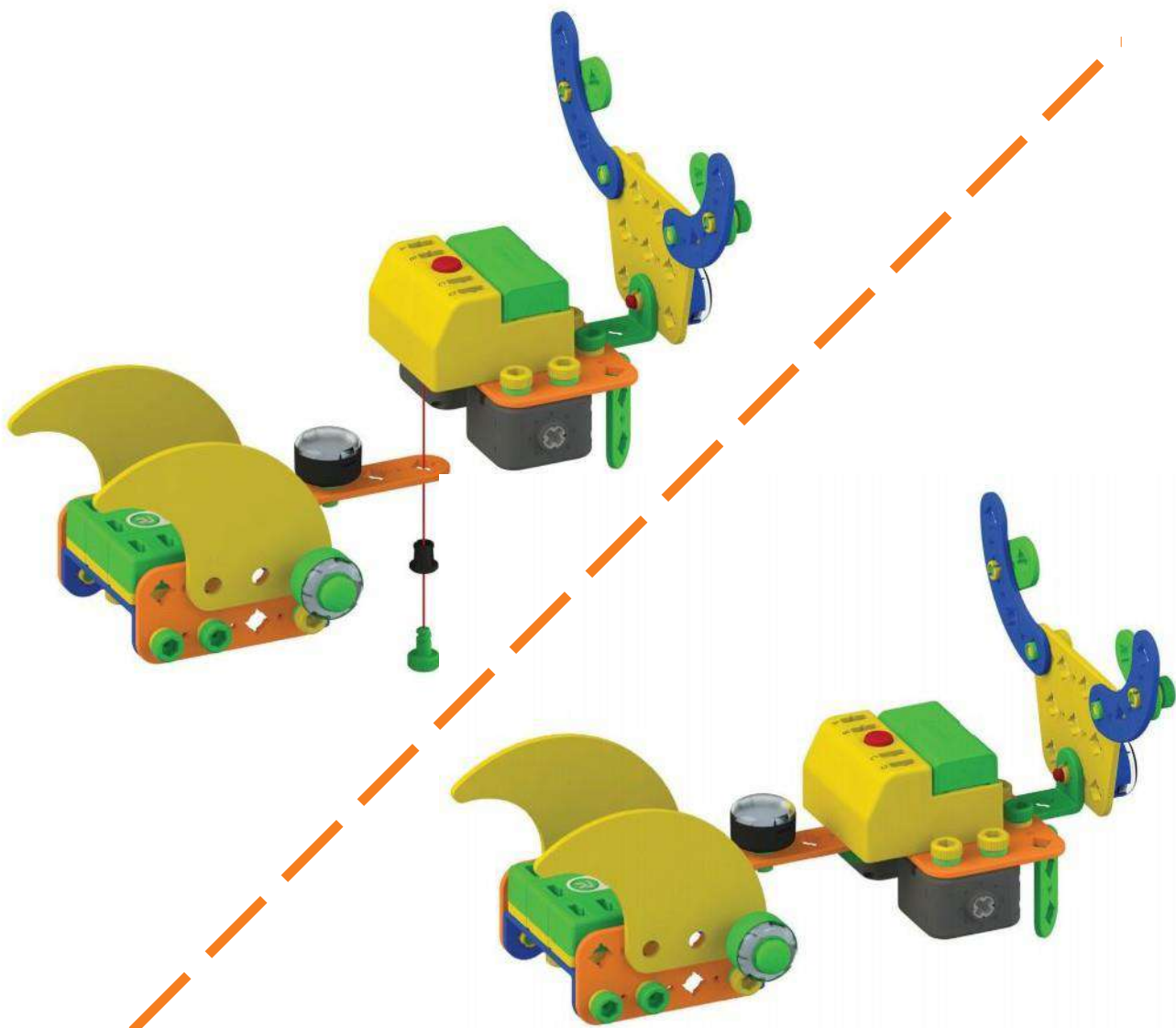

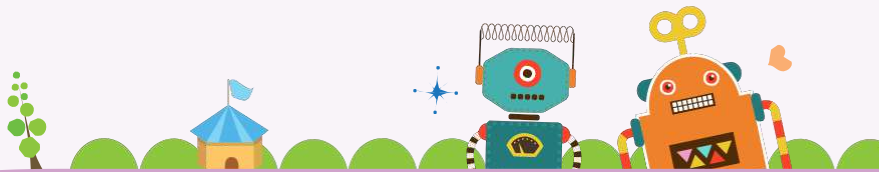

12

Детали



x2

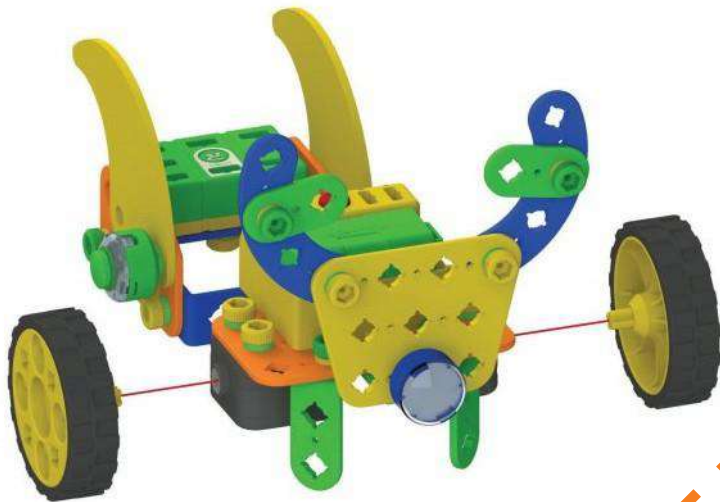

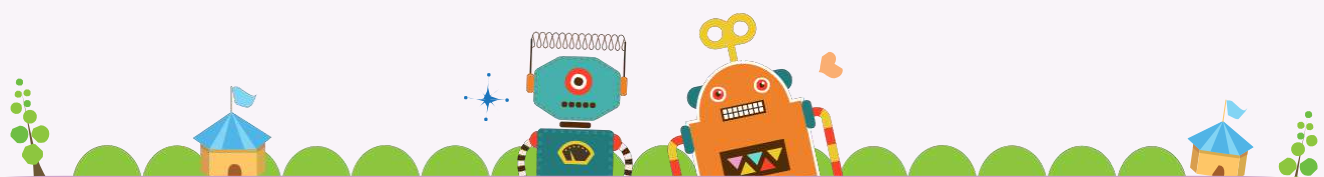

Правый  
электродвигатель  
Подключите к В

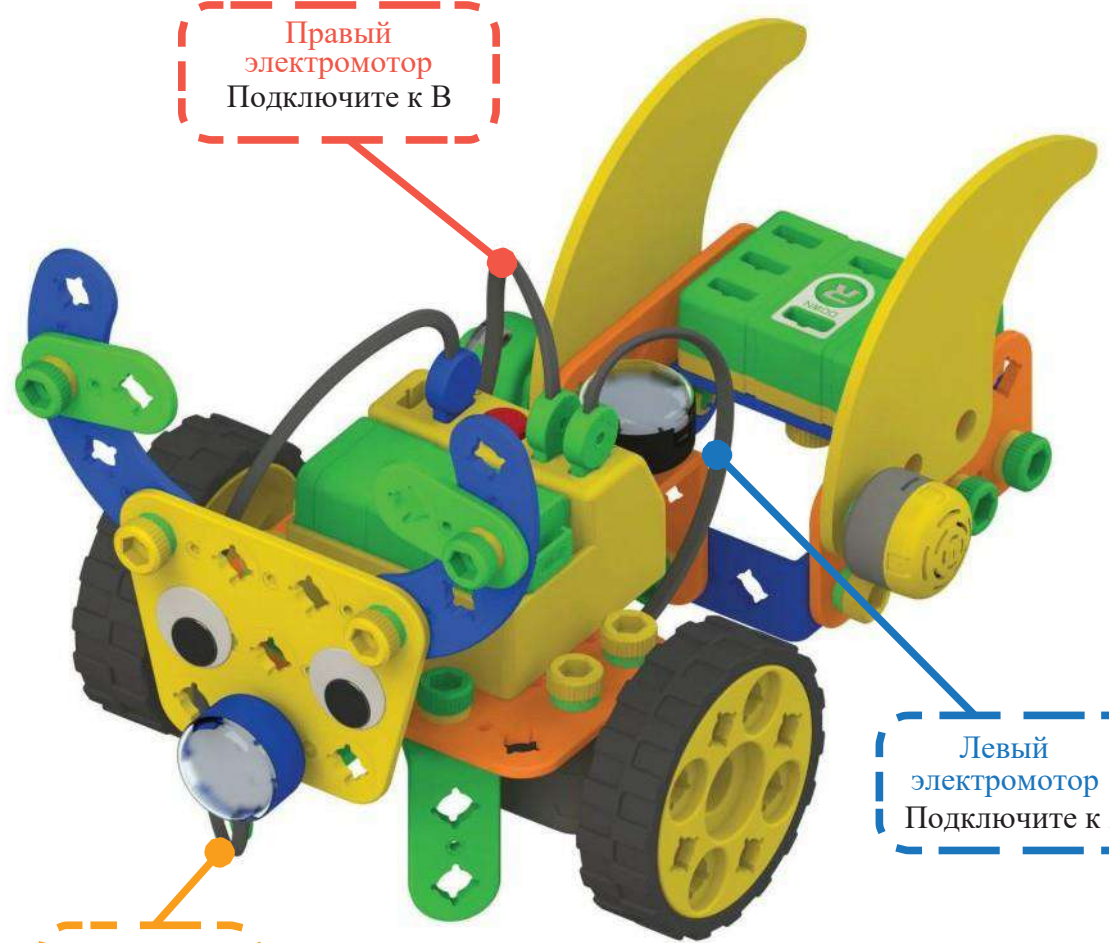

Левый  
электродвигатель  
Подключите к А

LED  
Подключите к С

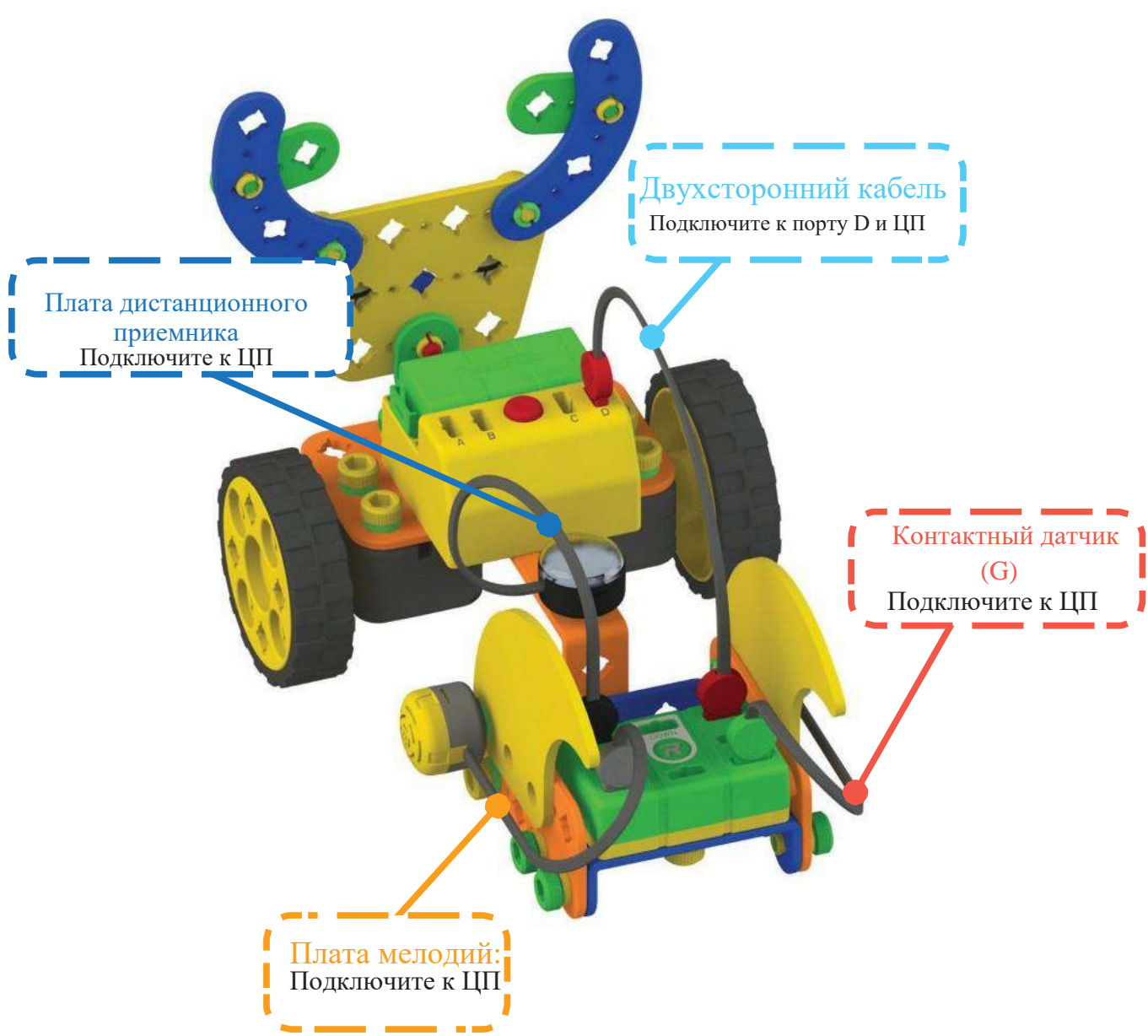
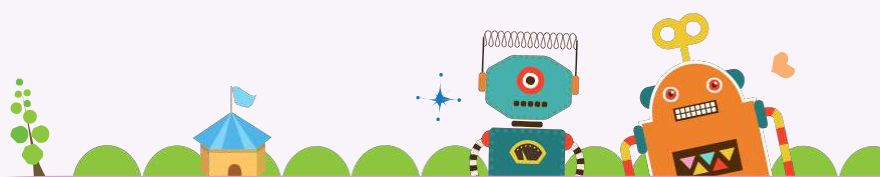



Запрограммируем движение робота Рудольфа на программной плате.



Управляйте Рудольфом с помощью устройства дистанционного управления

4-й

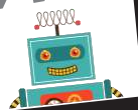

Сыграем с роботом- снегоочистителем!



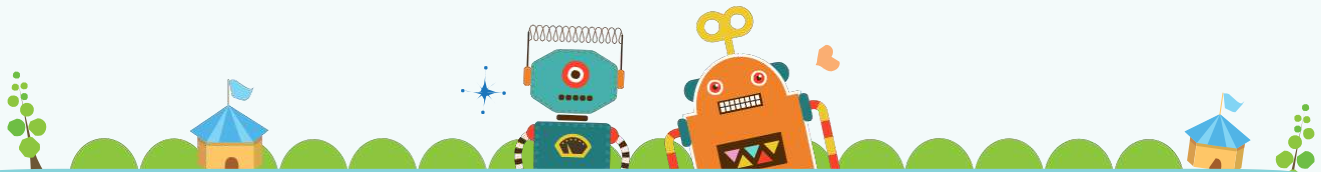

Детали



x2



x1



x2



x2

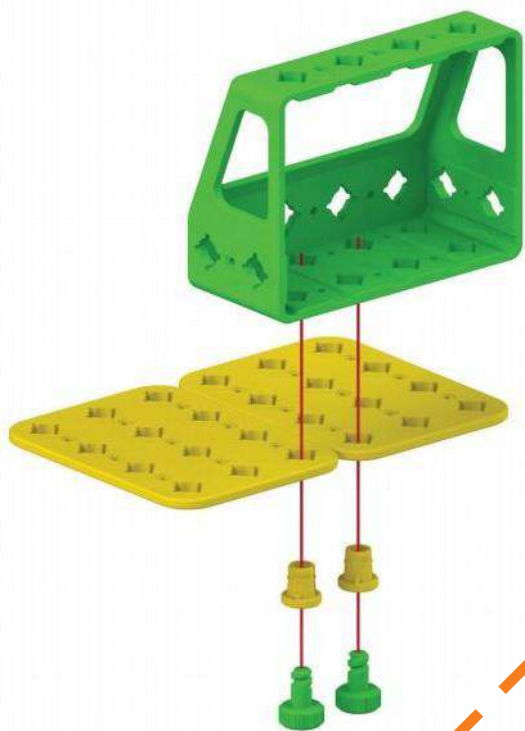



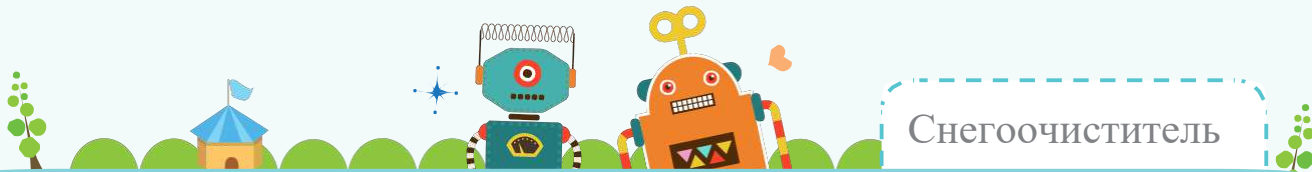

2 Детали



x2



x2



x2

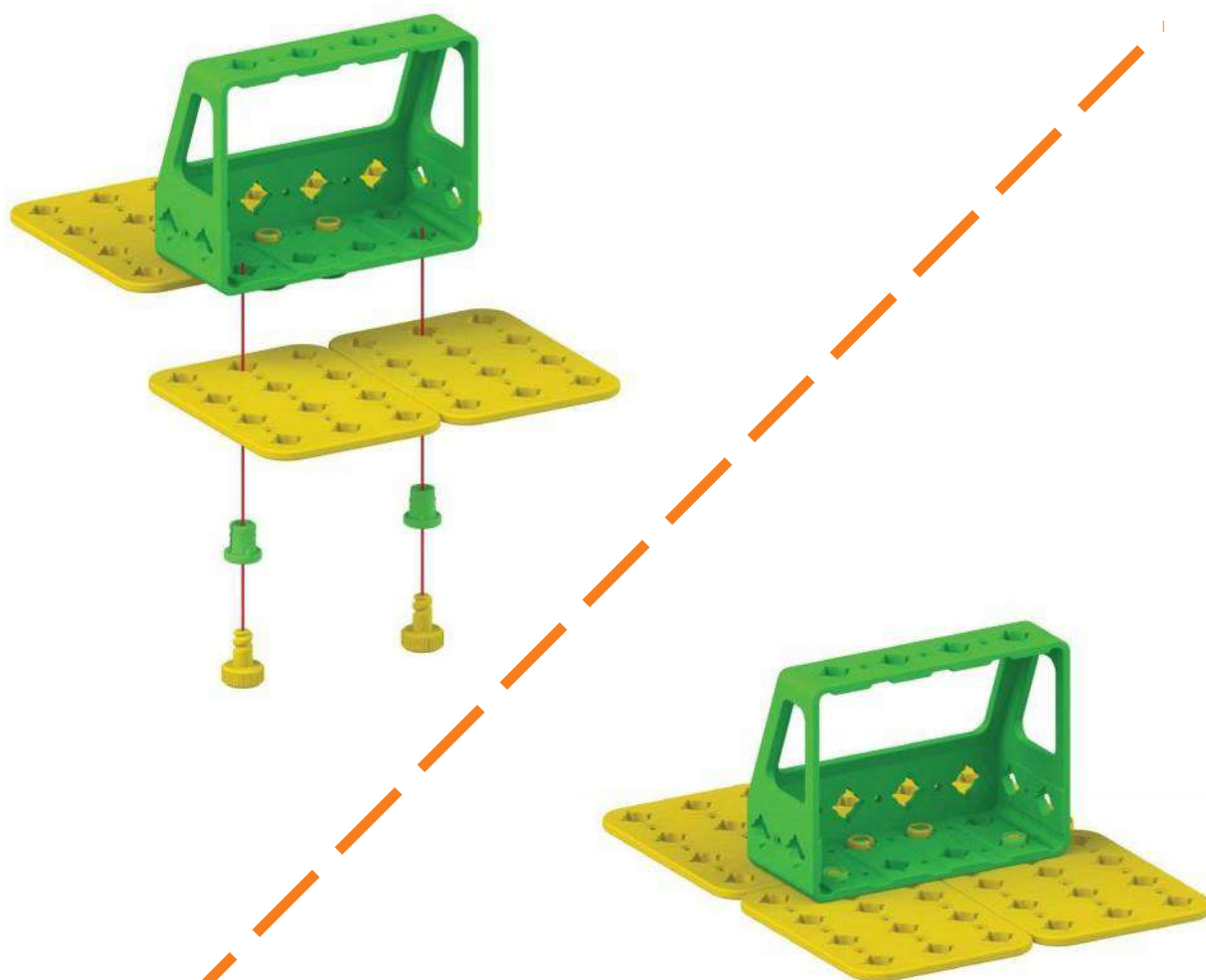

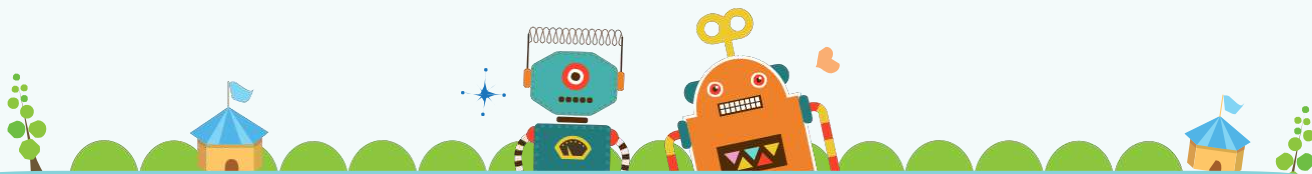

3

Детали



x2



x4



x4

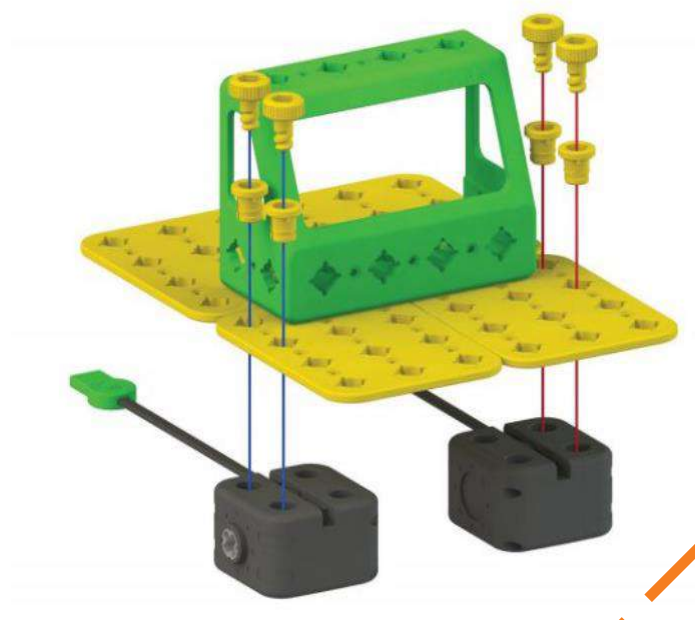

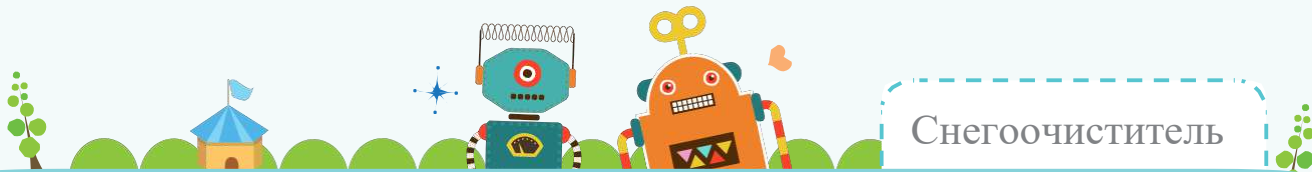

4 Детали



x2



x2



x2



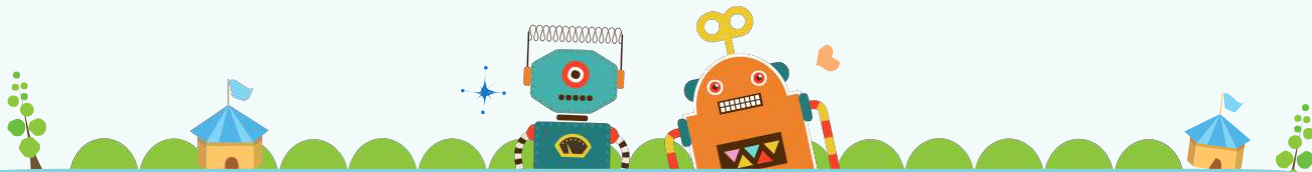

5

Детали



x2



x2



x2

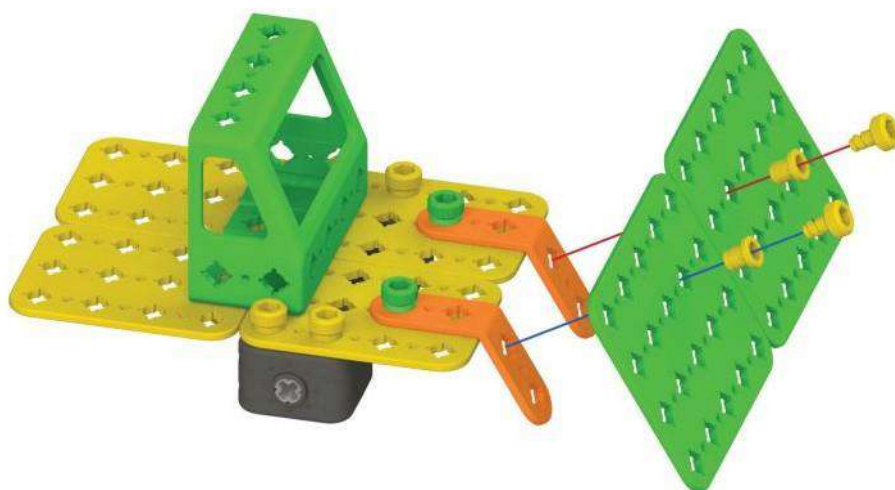

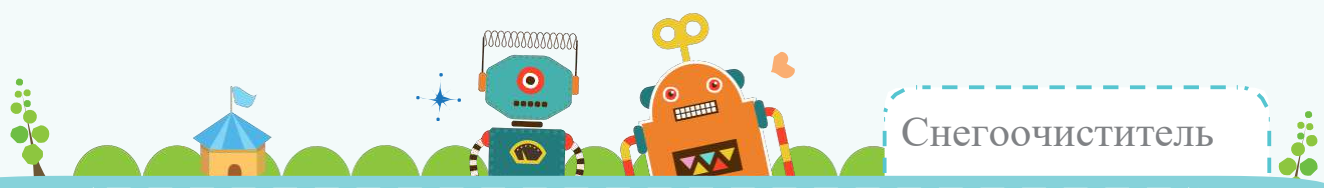

6

Детали



x1



x2



x2

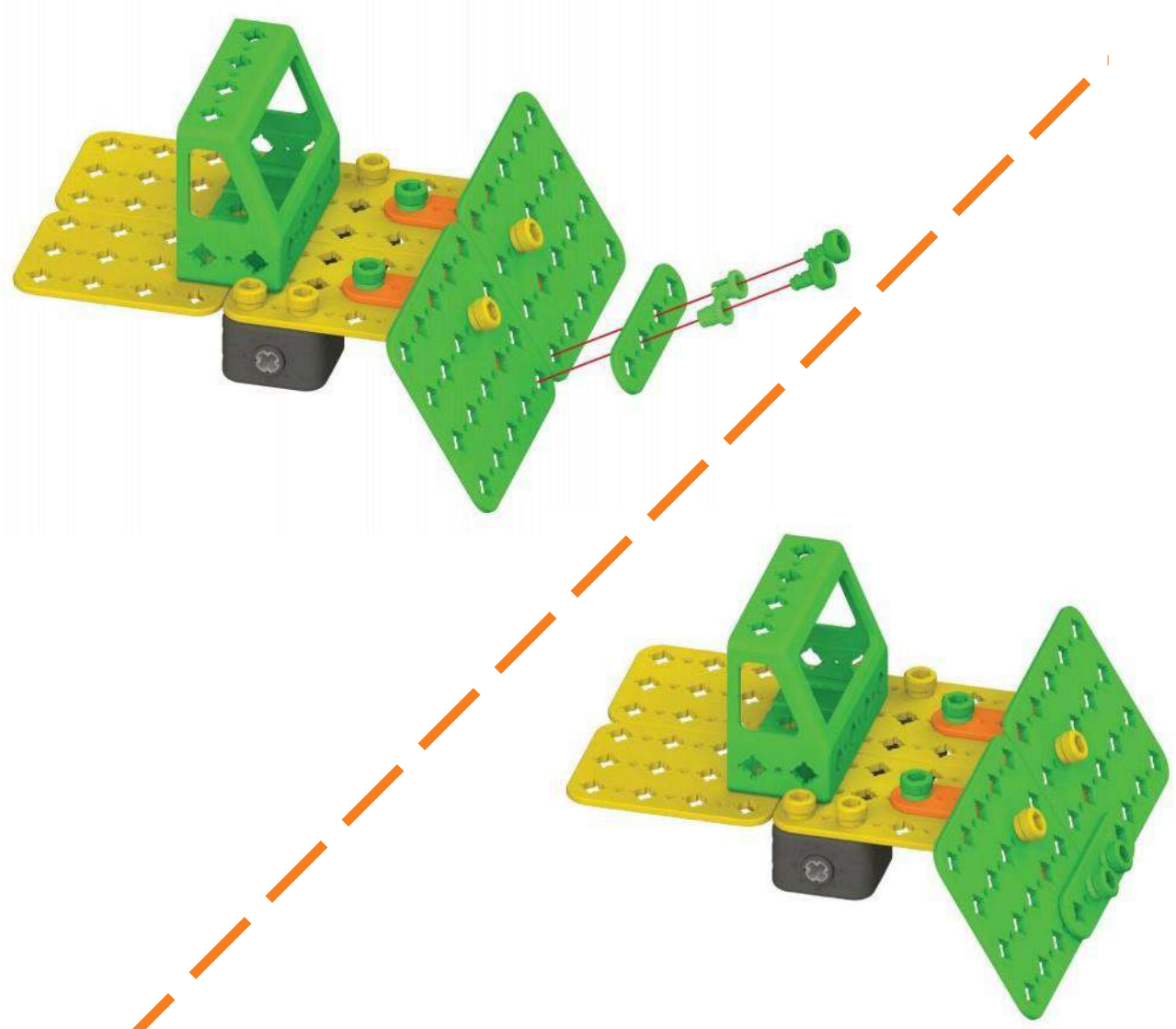

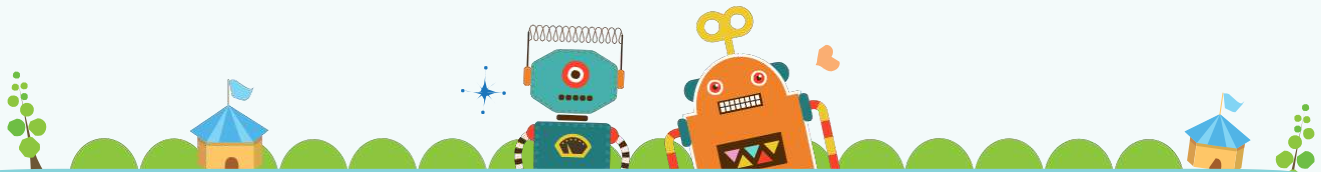

Детали



x2



x1



x2



x2

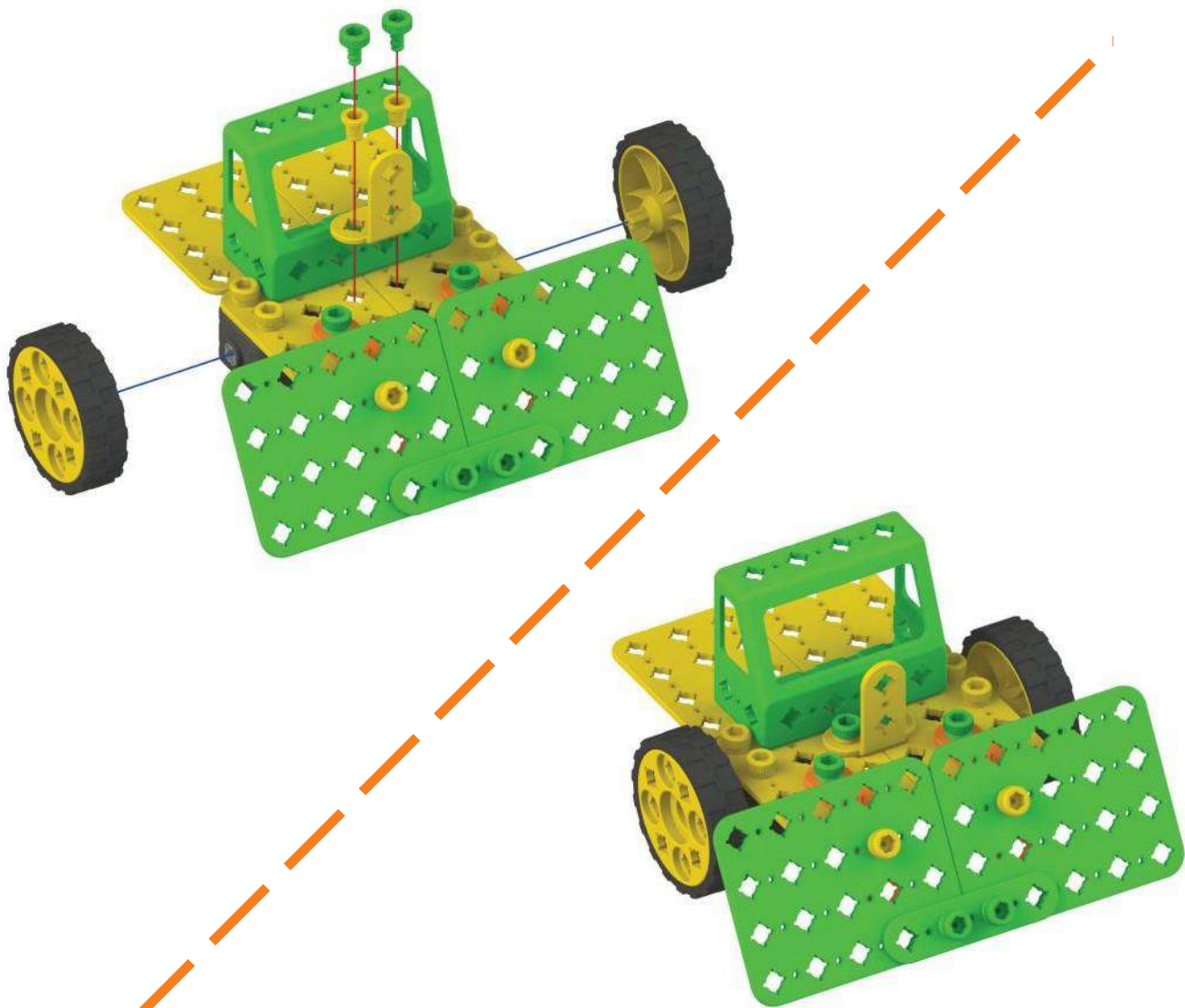

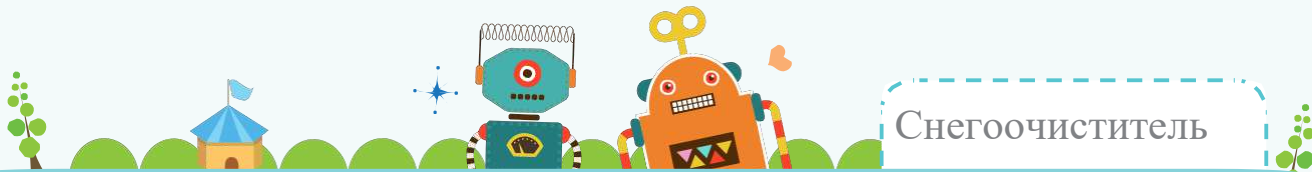

Детали



x2



x2



x2

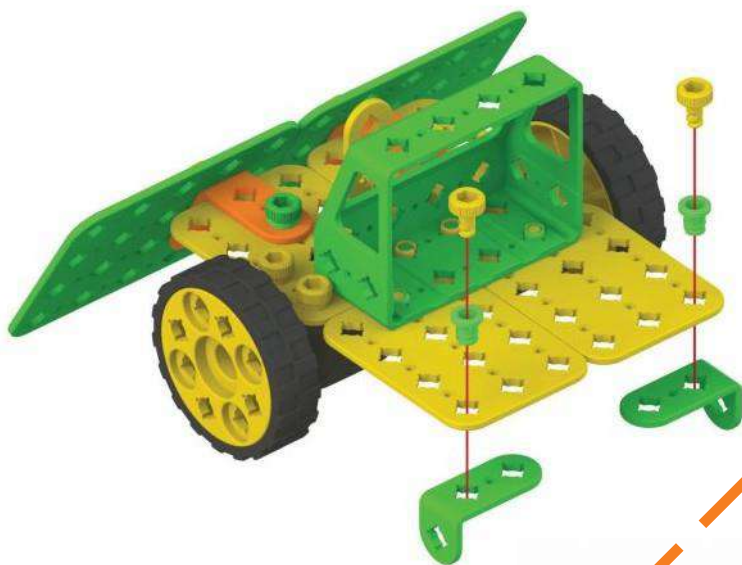

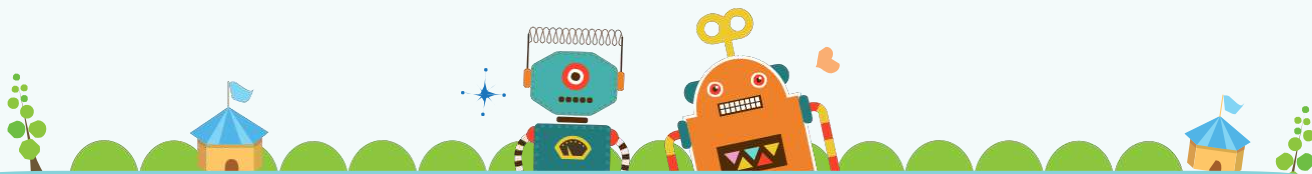

9

Детали



x1



x2



x2

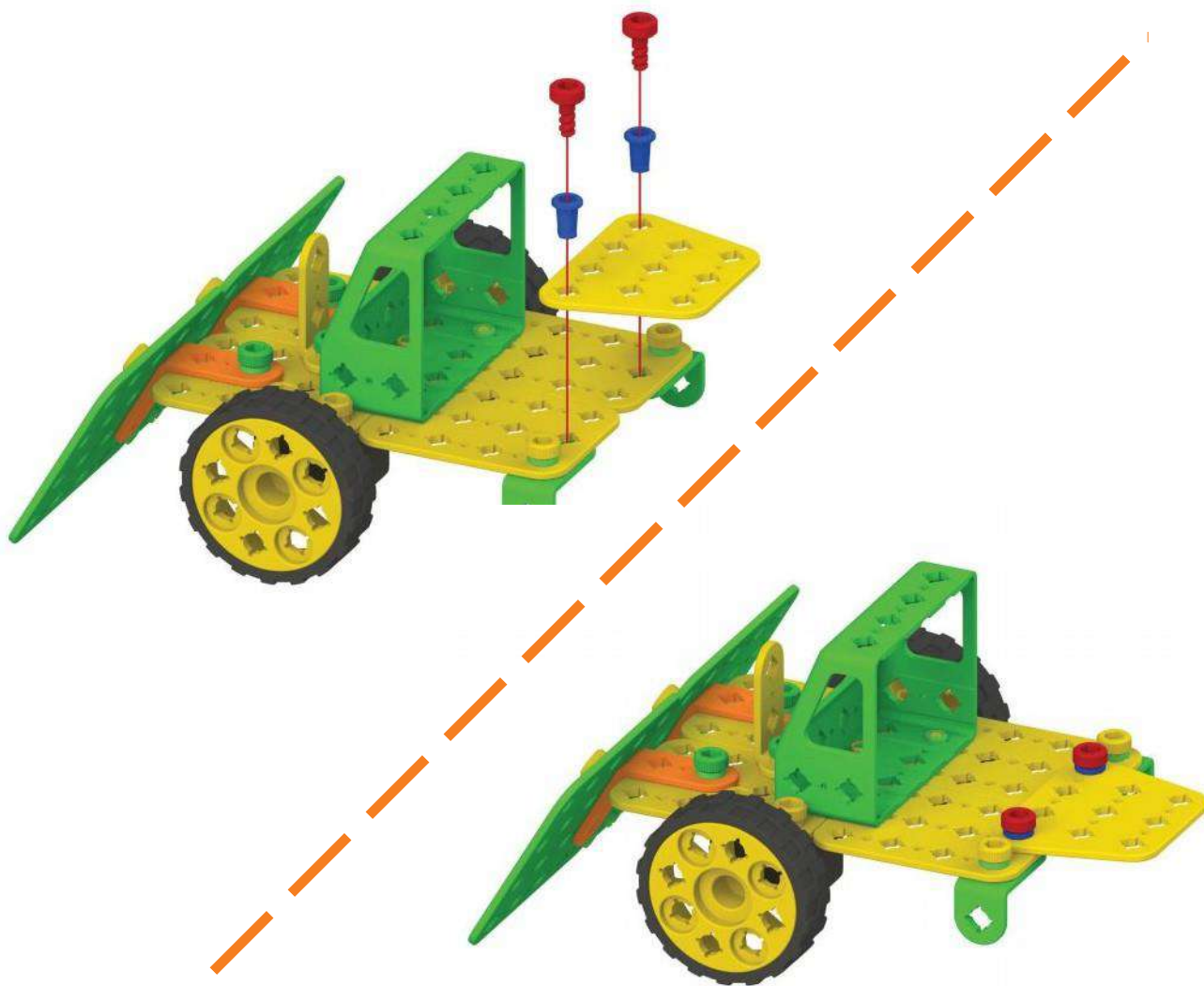



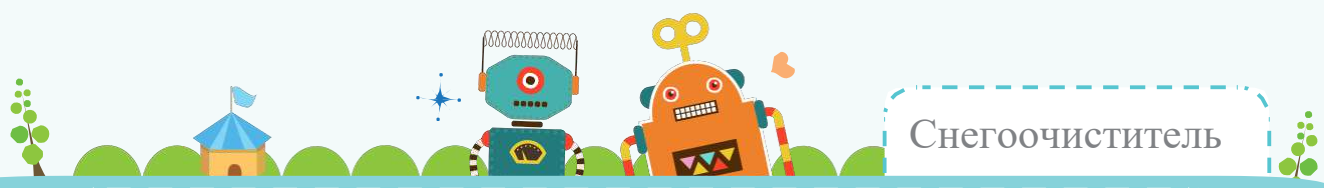

10

Детали



x1



x2



x2



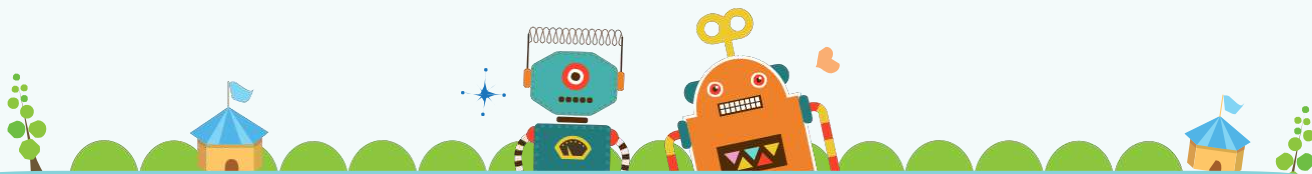

Детали



x2



x2



x2

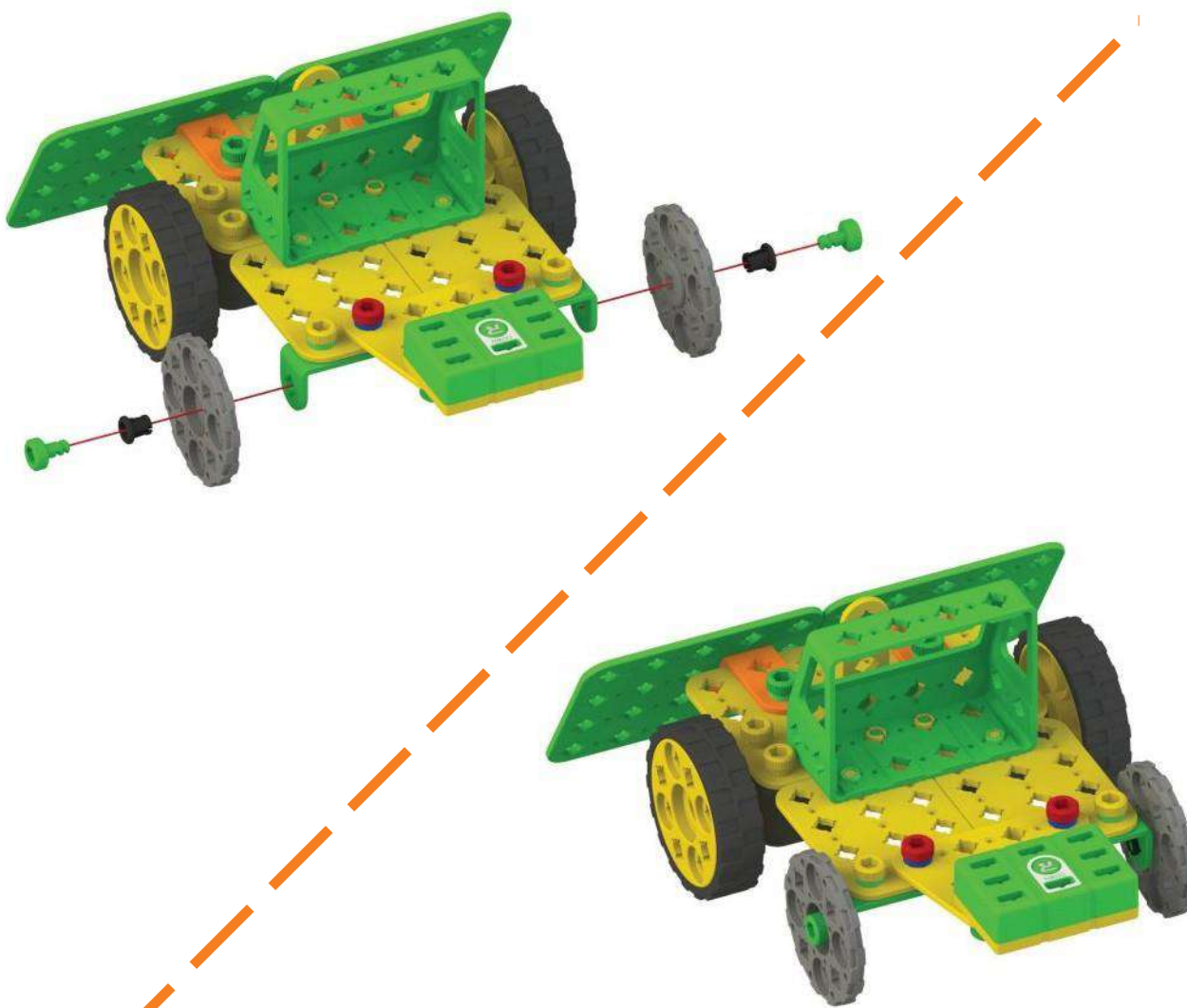

12

Детали



x2



x4



x4



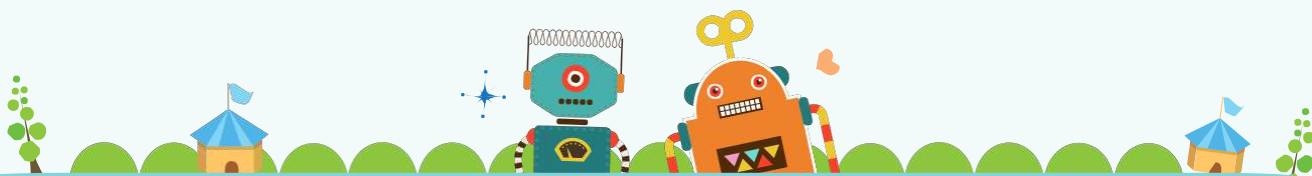

13

Детали



x1



x1



x2



x2

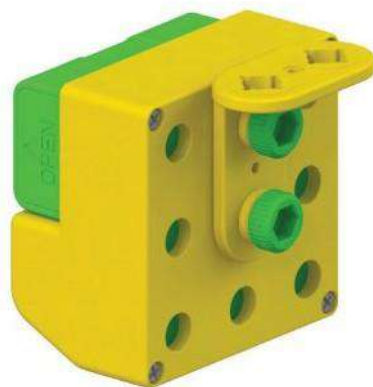
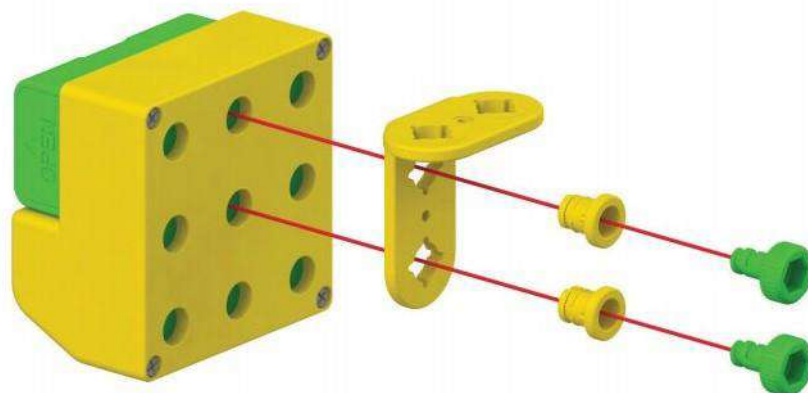

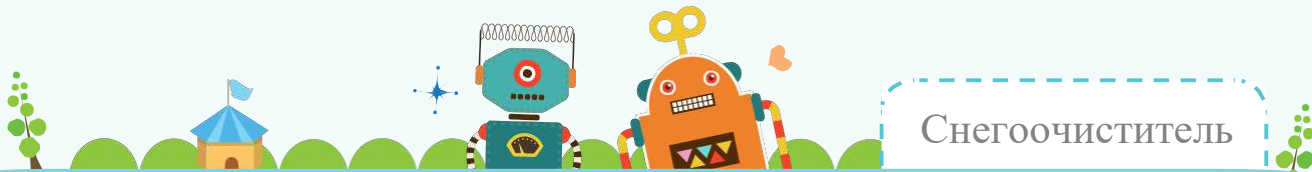

14

Детали



x2



x2

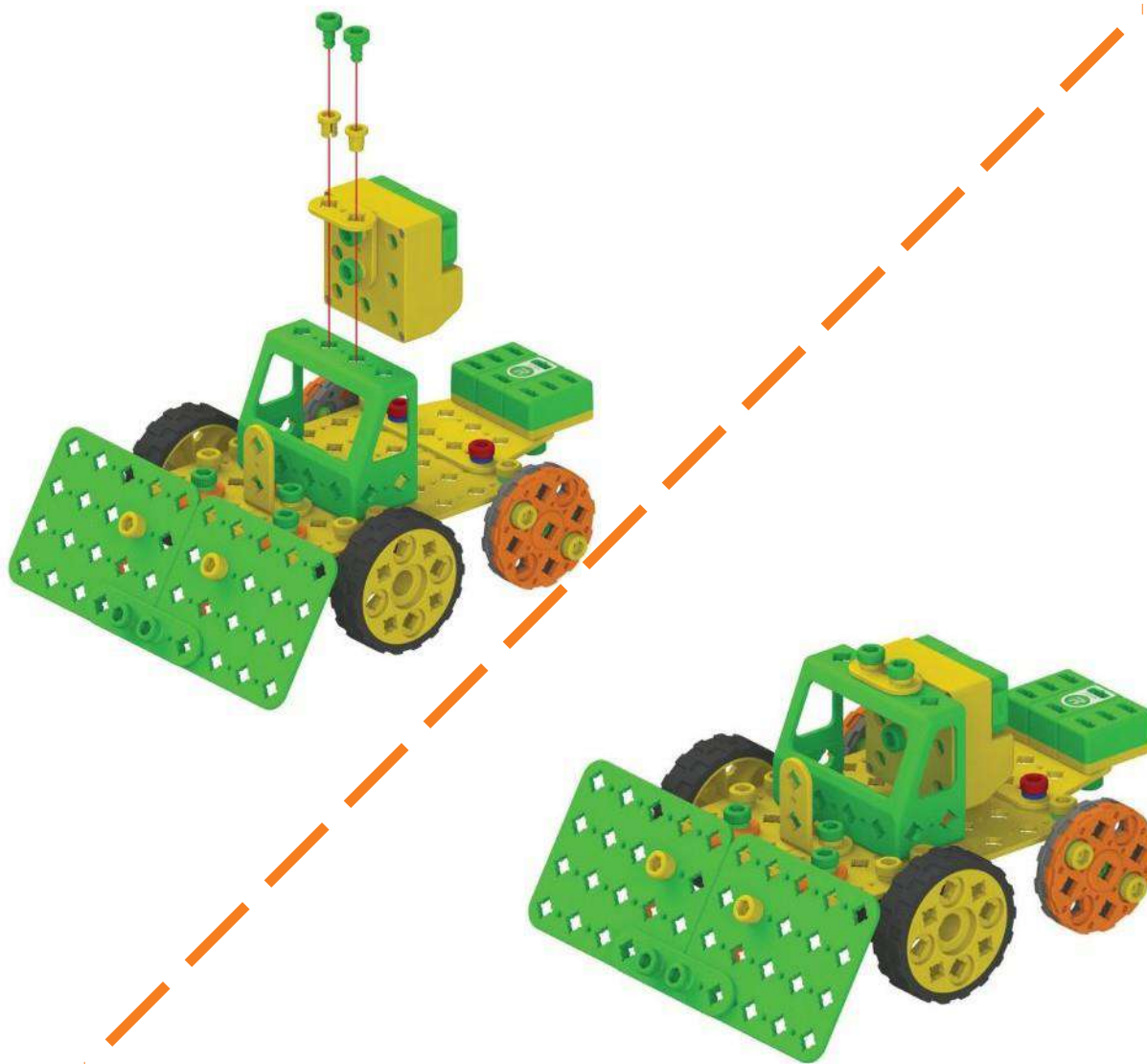

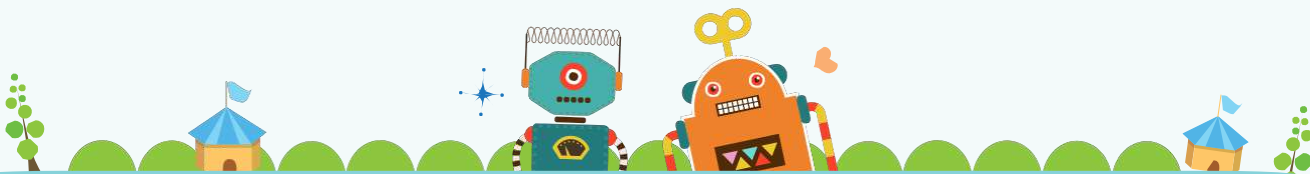

15

Детали



x1



x1



x1



x1



x1

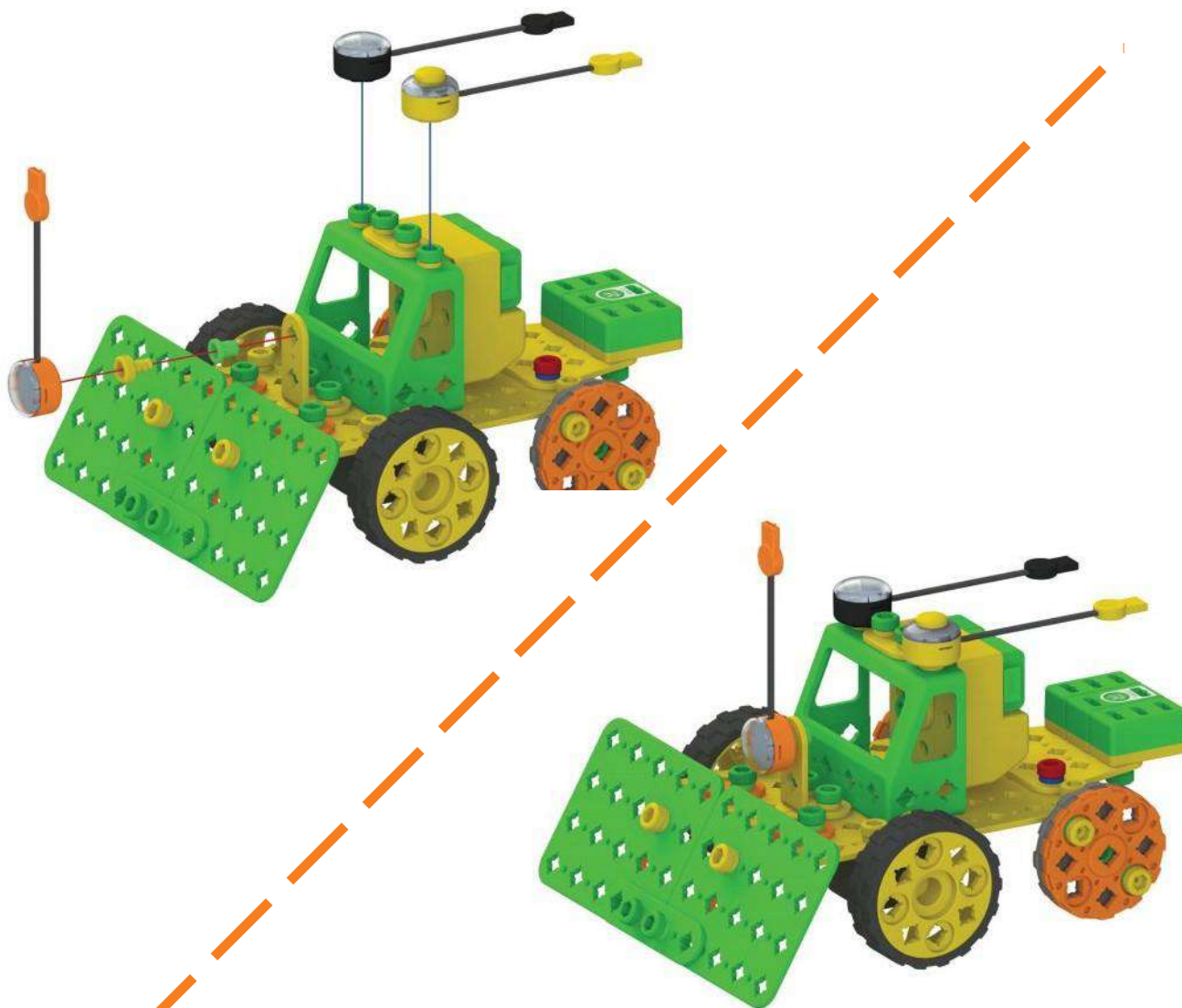

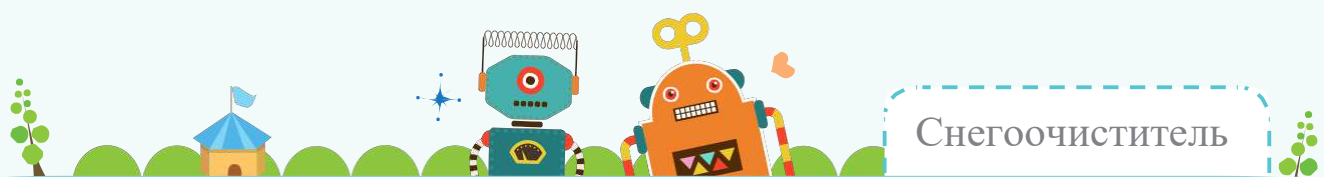

# Снегоочиститель

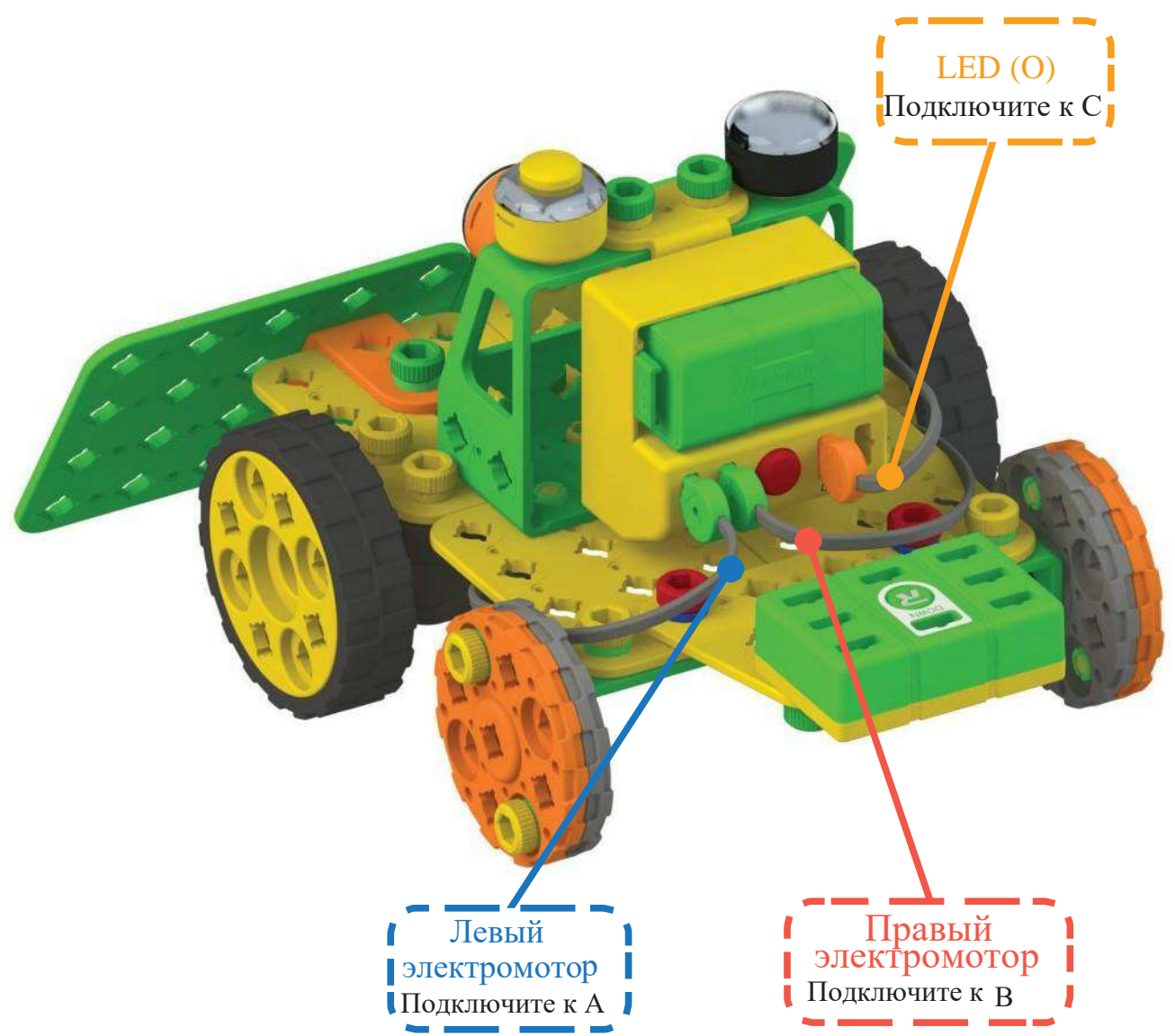

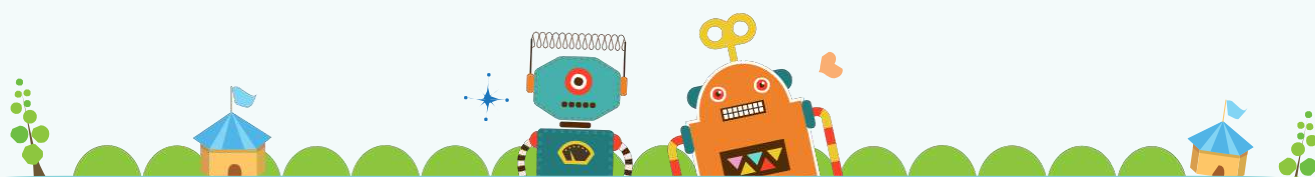

Контактный датчик (Y)  
Подключите к ЦП

Плата дистанционного  
приемника  
Подключите к ЦП

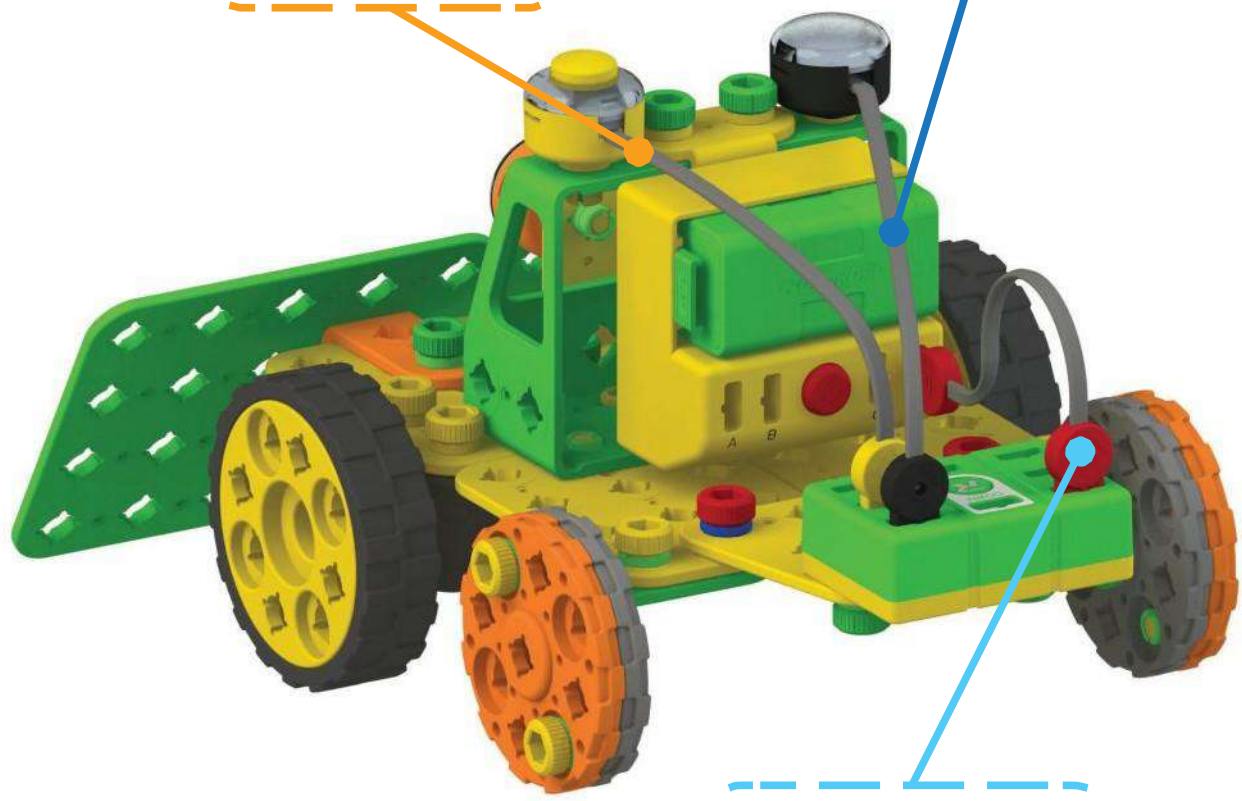

Двухсторонний кабель  
Подключите к порту D  
и ЦП



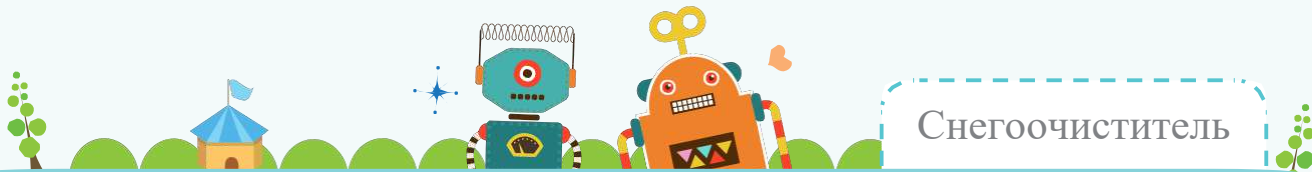

Запрограммируем движение снегоочистителя на программной плате.



Управляйте снегоочистителем с помощью устройства дистанционного управления



Сыграем со светлячком!

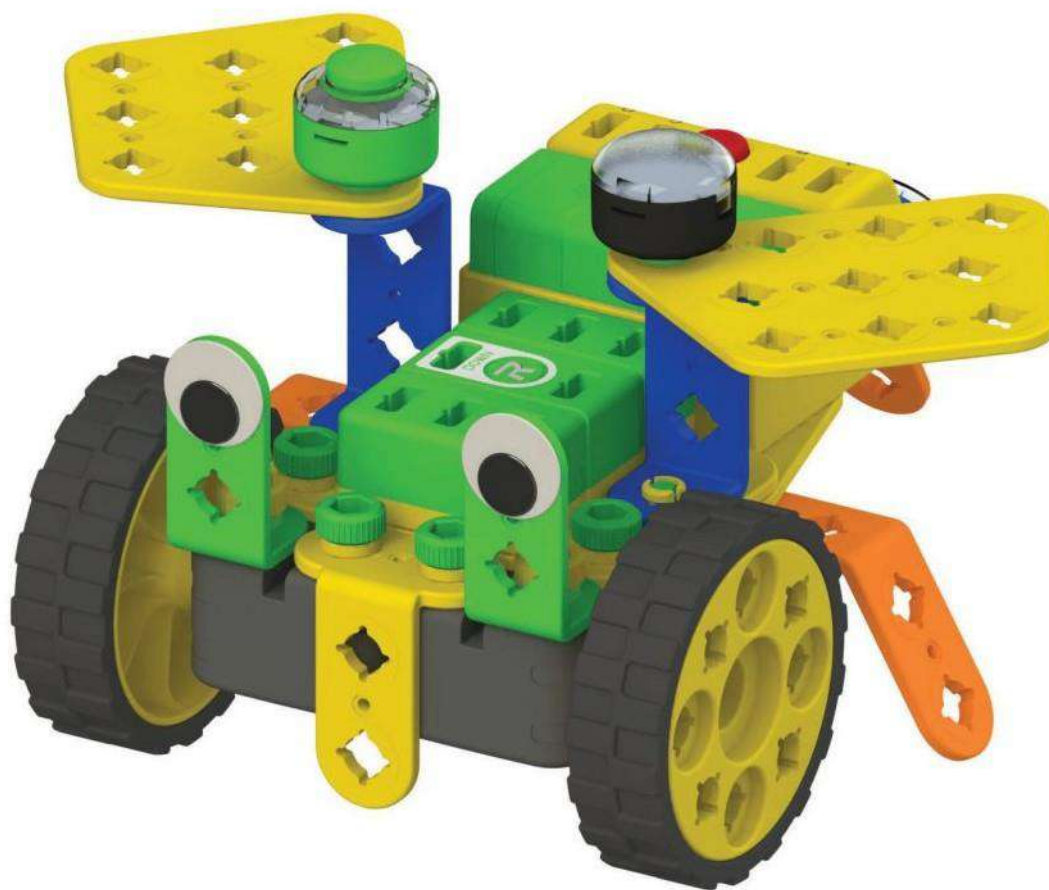

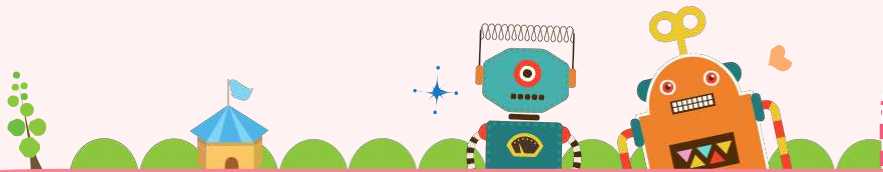

Детали



x1



x1



x2



x2



x2

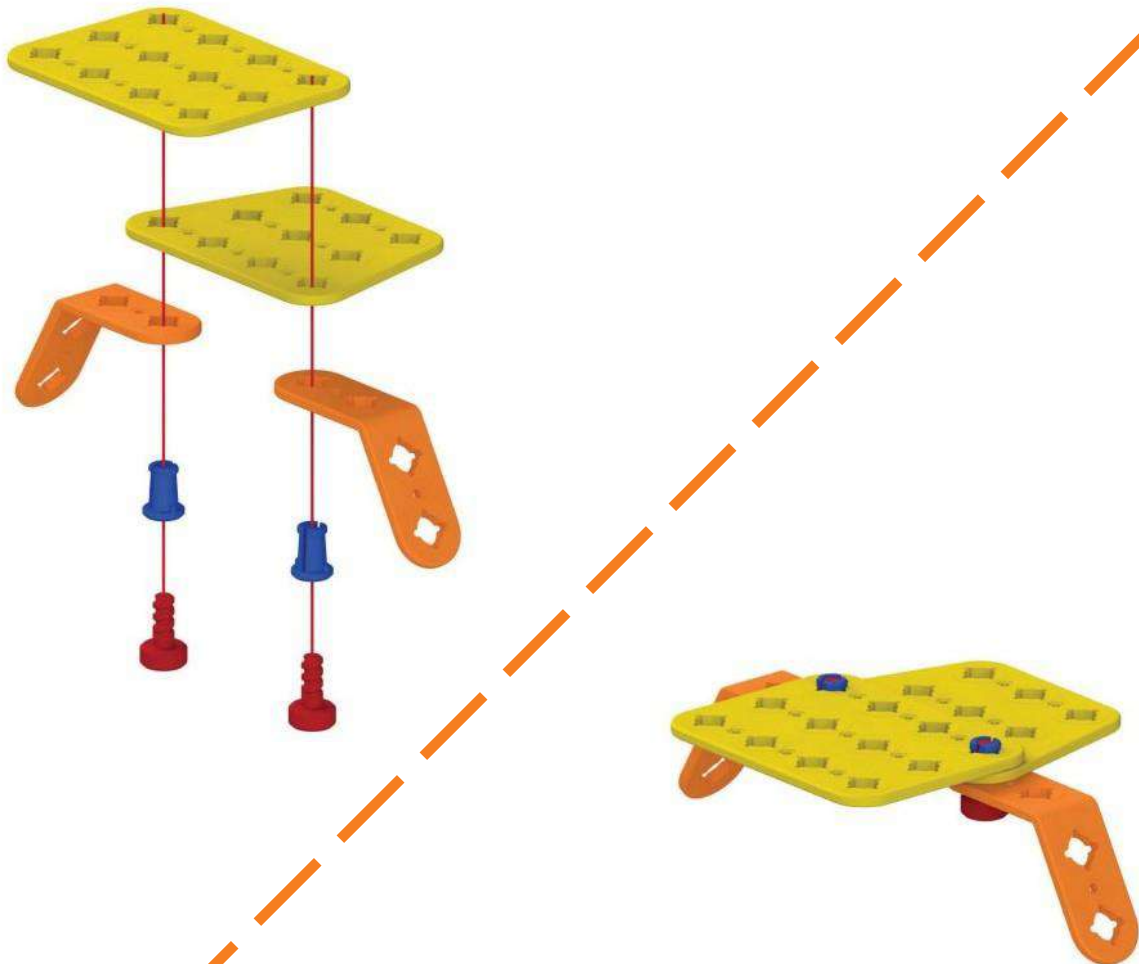

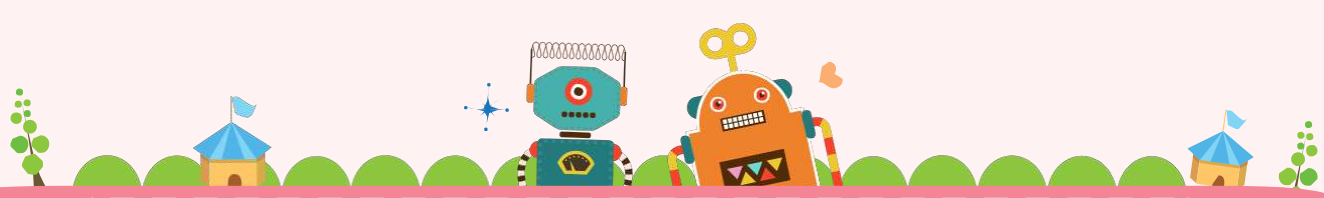

2

Детали



x2



x2



x2



Не закрепляйте  
кабель  
электромотора



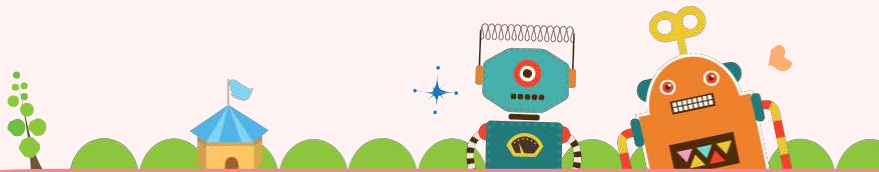

3 Детали



x2



x1



x2



x2



x2



x2

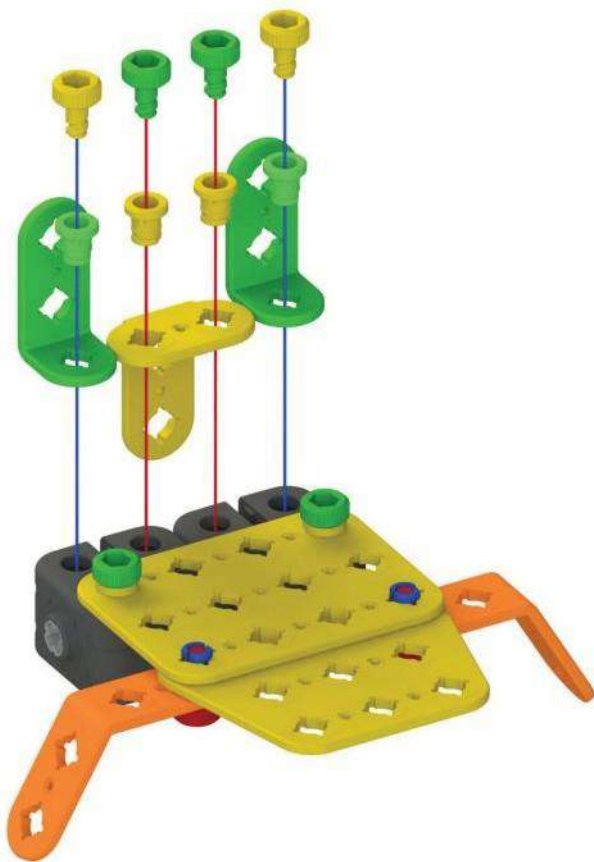

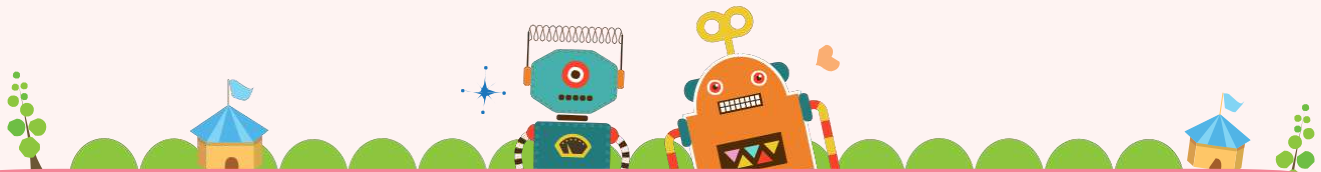

4

Детали



x1



x2



x2



x2



x2



x2

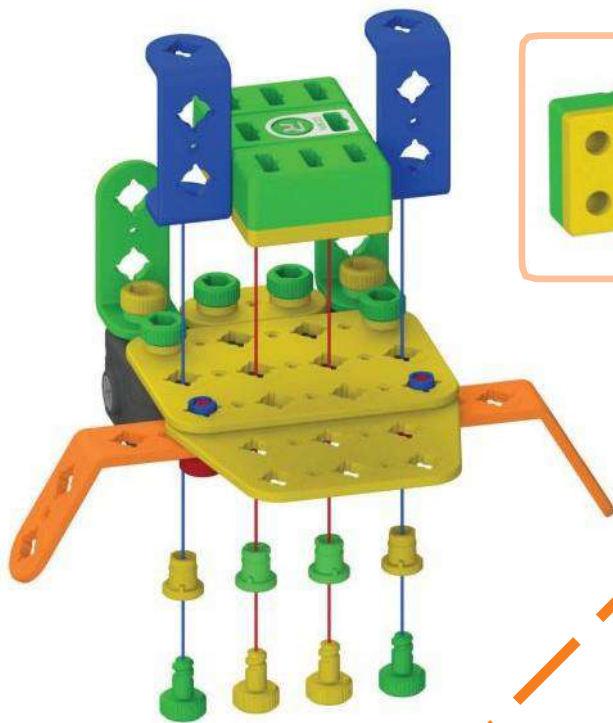

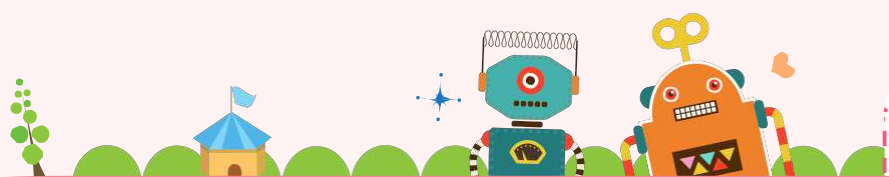

5

Детали



x1



x2



x2

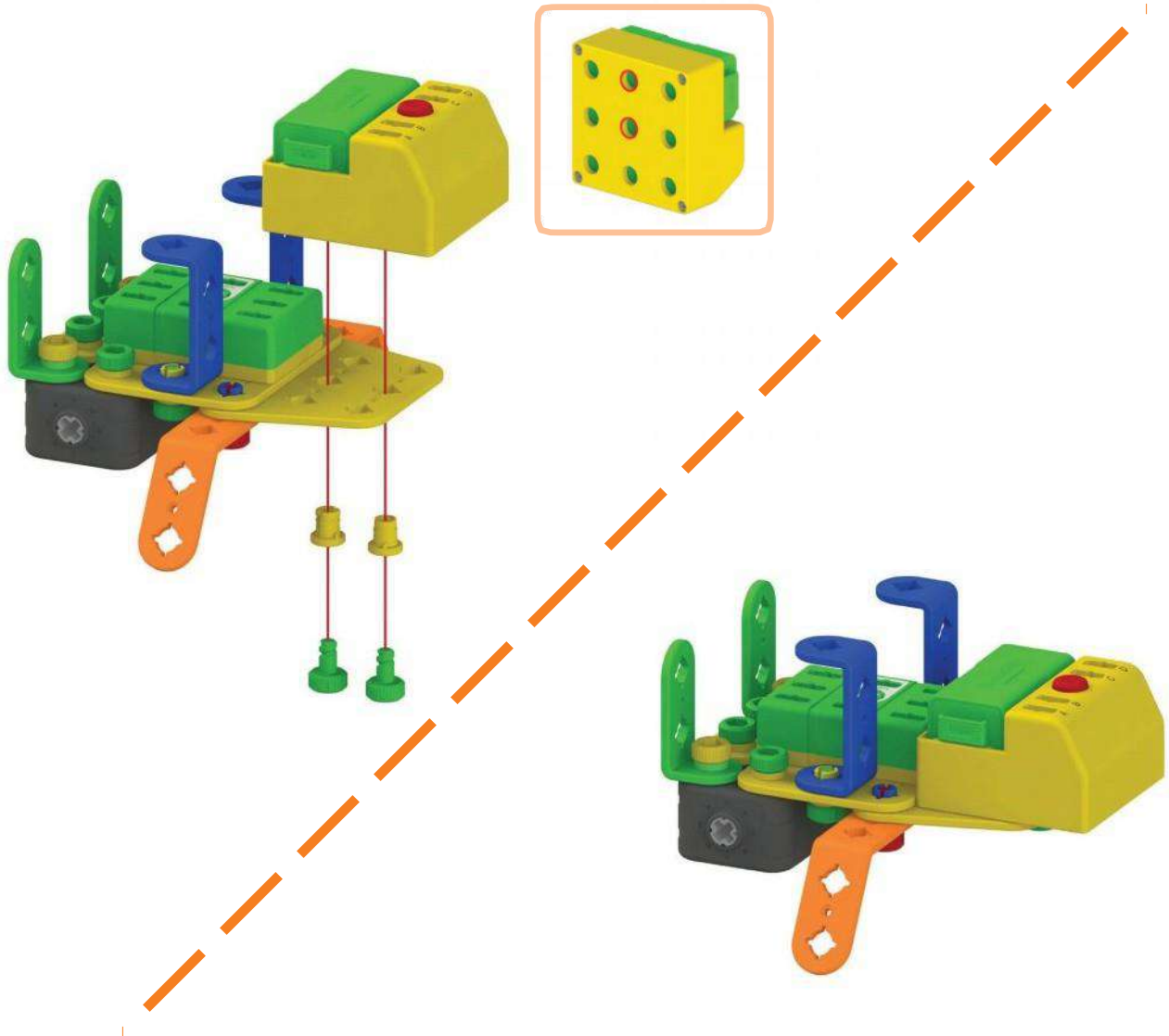

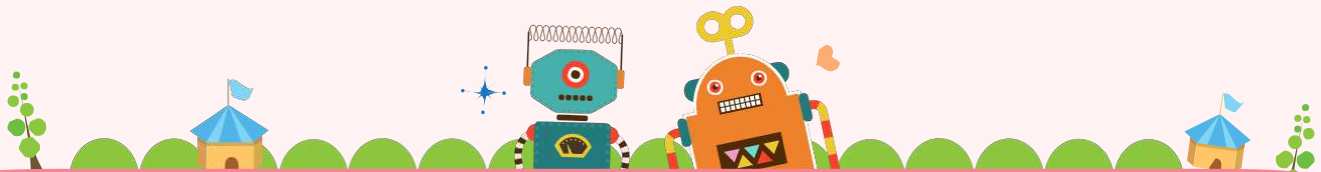

6

Детали



x2



x1



x1



x2



x2



x1

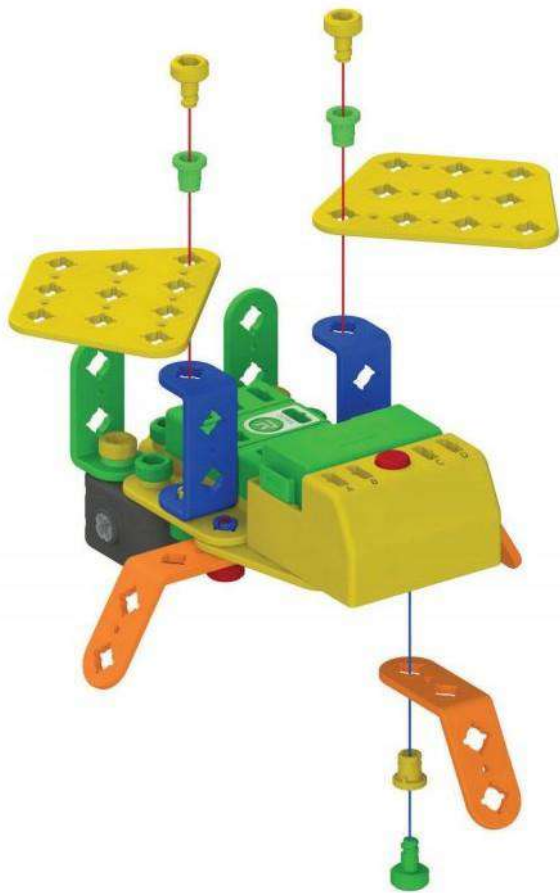



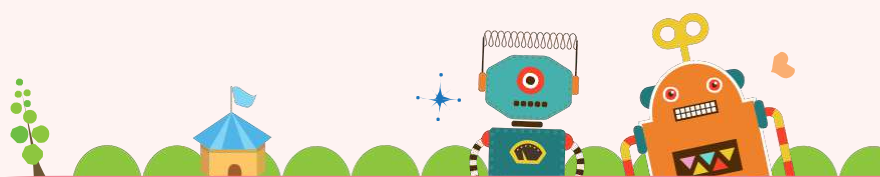

Детали



x1



x1



x1



x1



x1

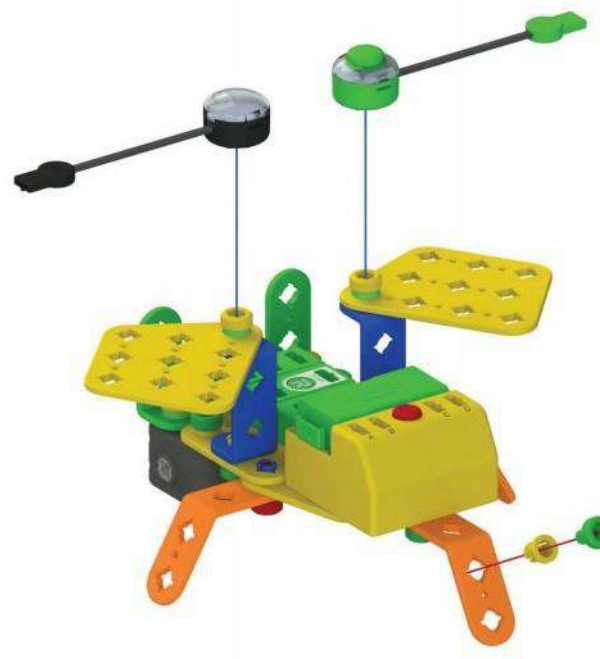

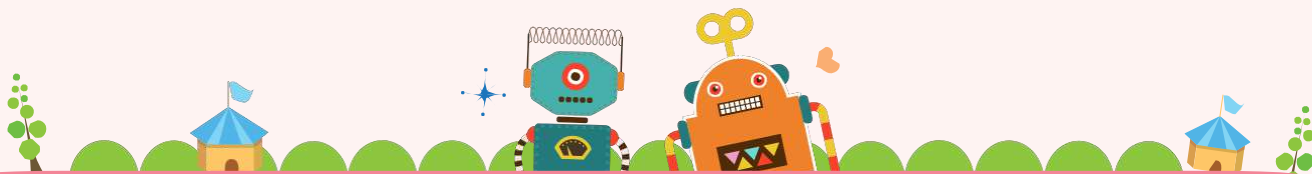

8

Детали



x2

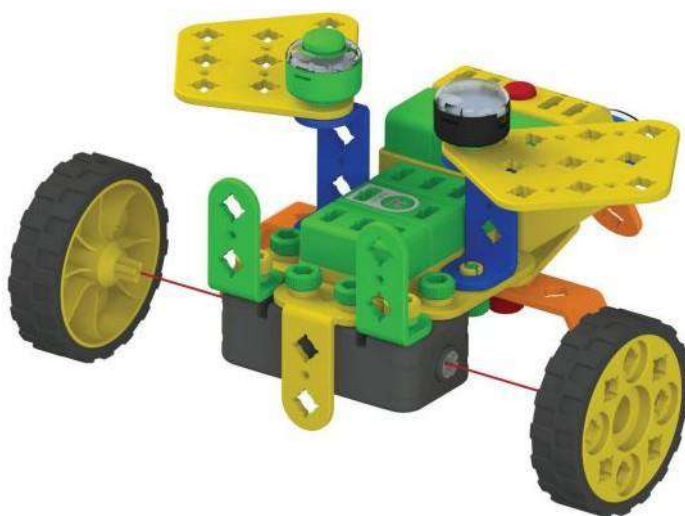

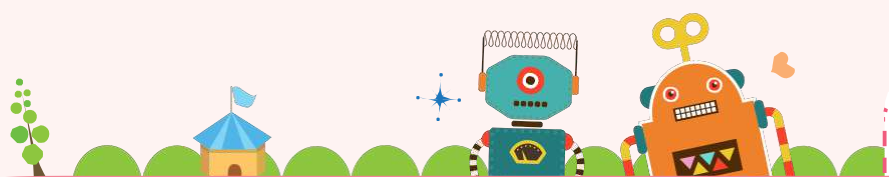

# Светлячок

Левый  
электромотор  
Подключите к А

Правый  
электромотор  
Подключите к В



LED  
Подключите к ЦП

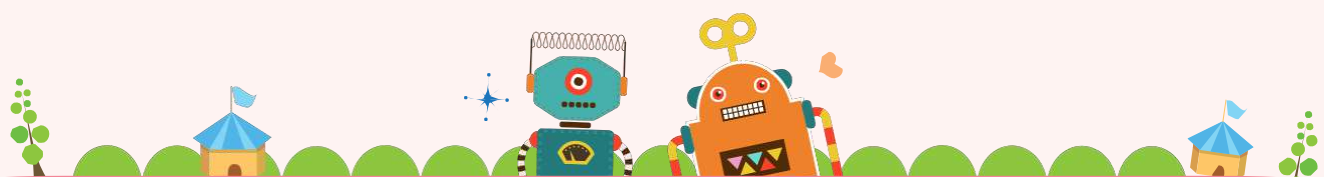

Контактный датчик (G)  
Подключите к ЦП

Двухсторонний кабель  
Подключите к порту D и ЦП

Плата дистанционного  
приемника  
Подключите к ЦП

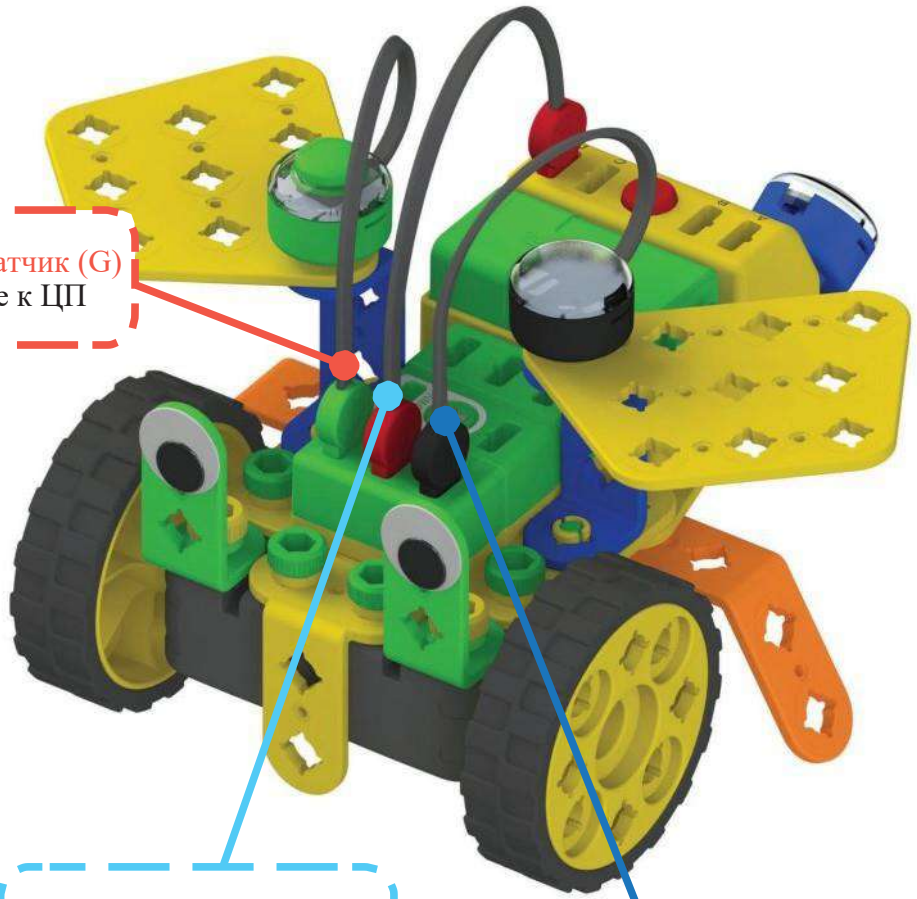

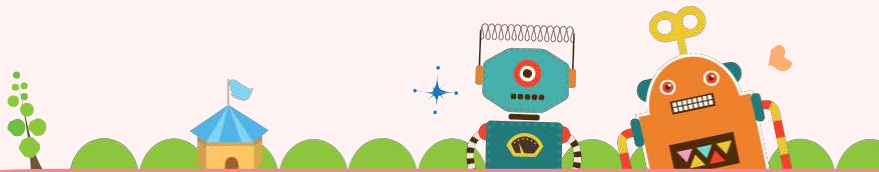

Запрограммируем движение робота светлячка на программной плате.



Управляйте светлячком с помощью устройства дистанционного управления



Сыграем с динозавром!





Детали



x1



x2



x4



x4

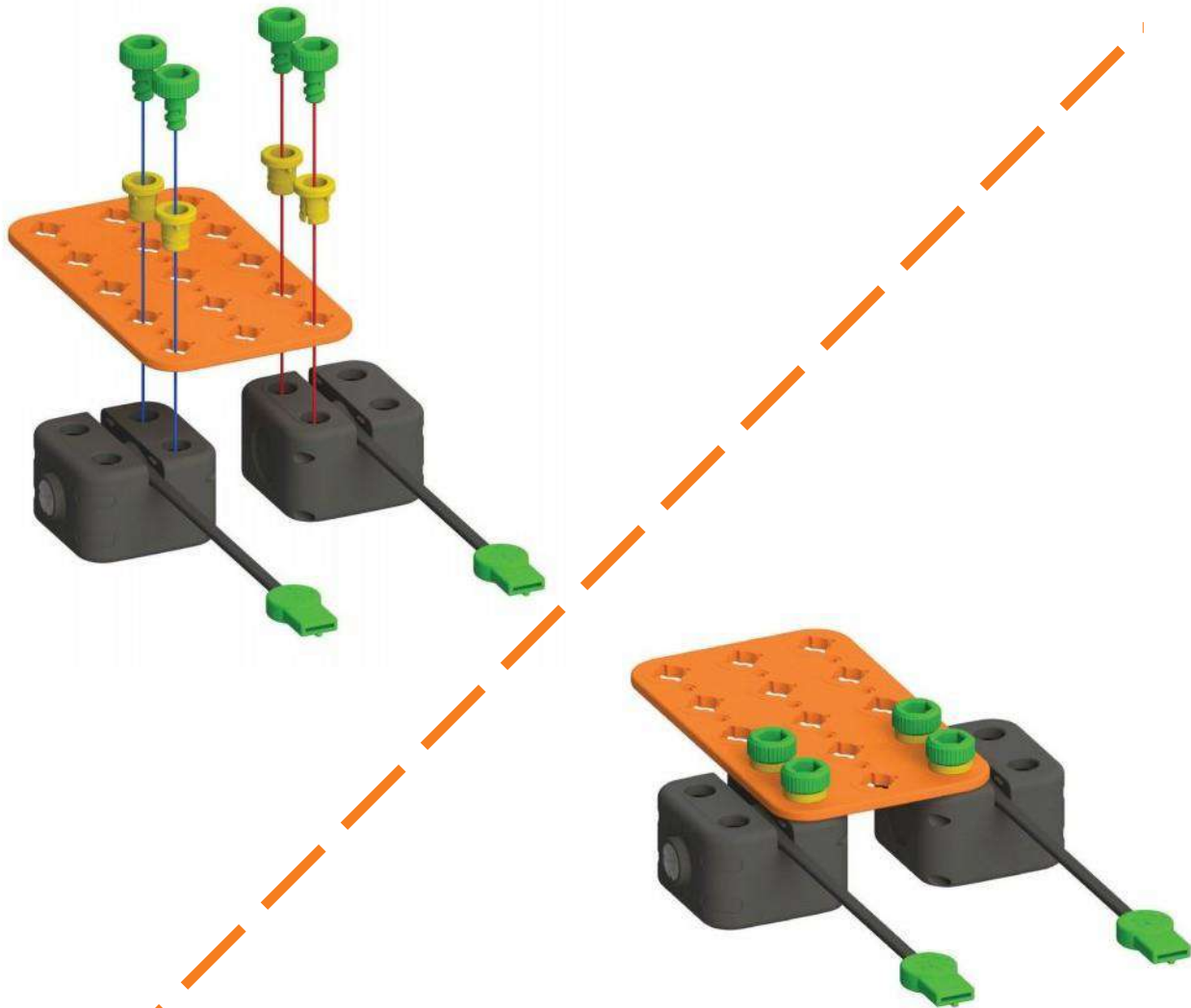

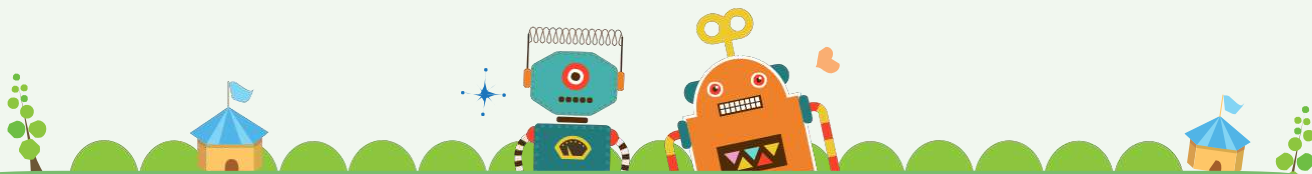

2

Детали



x1



x1



x1



x1





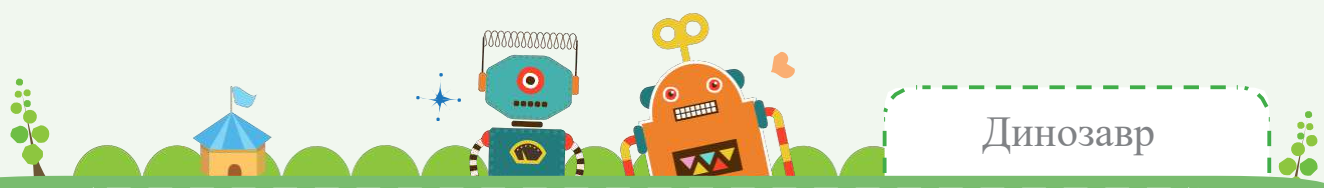

3 Детали



x1



x1



x1

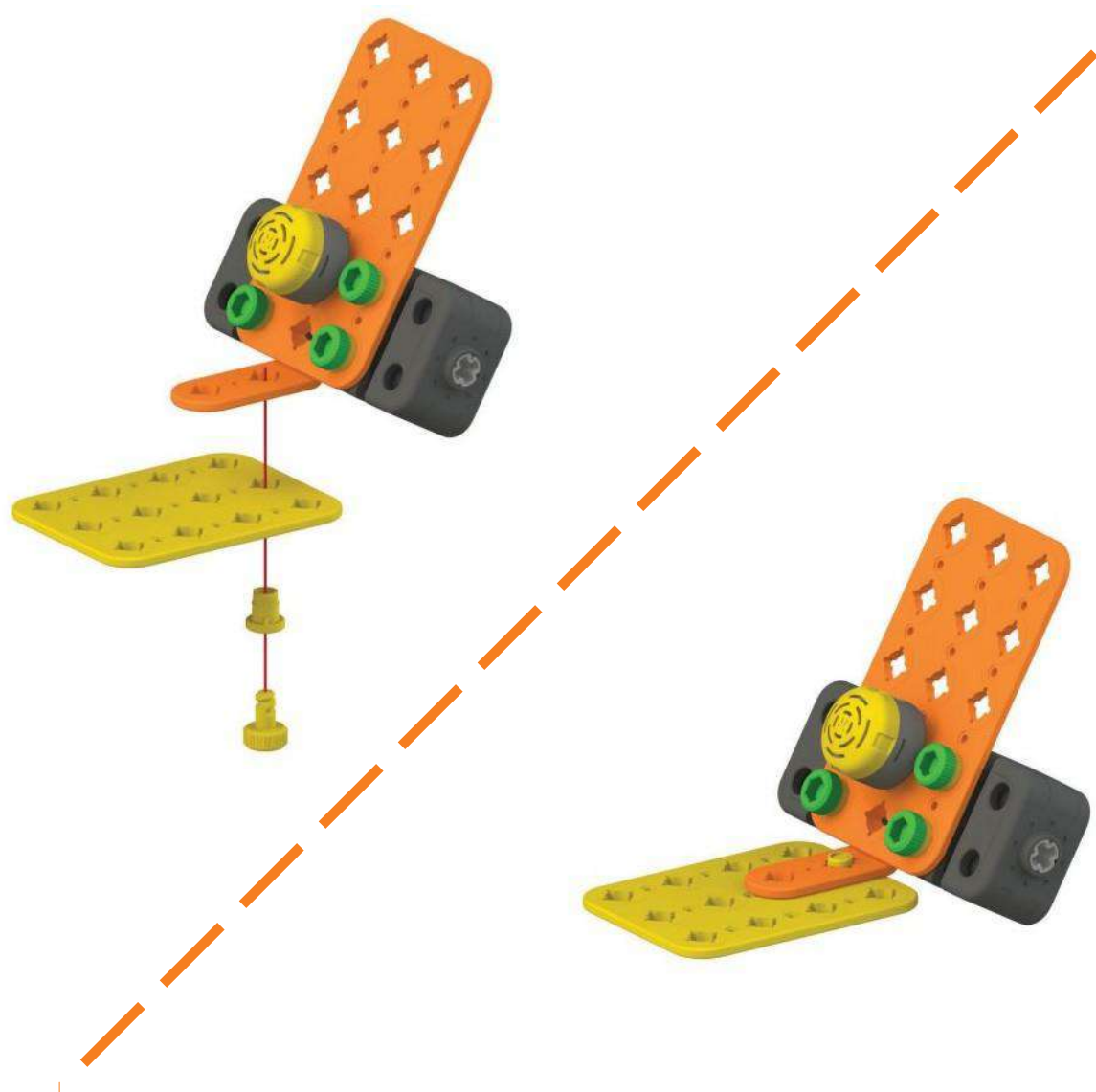

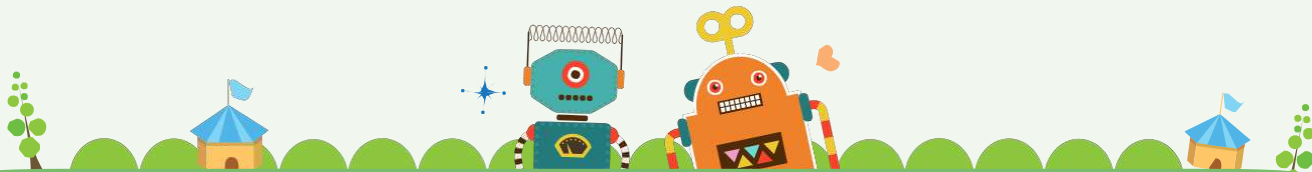

4

Детали



x1



x2



x3



x3

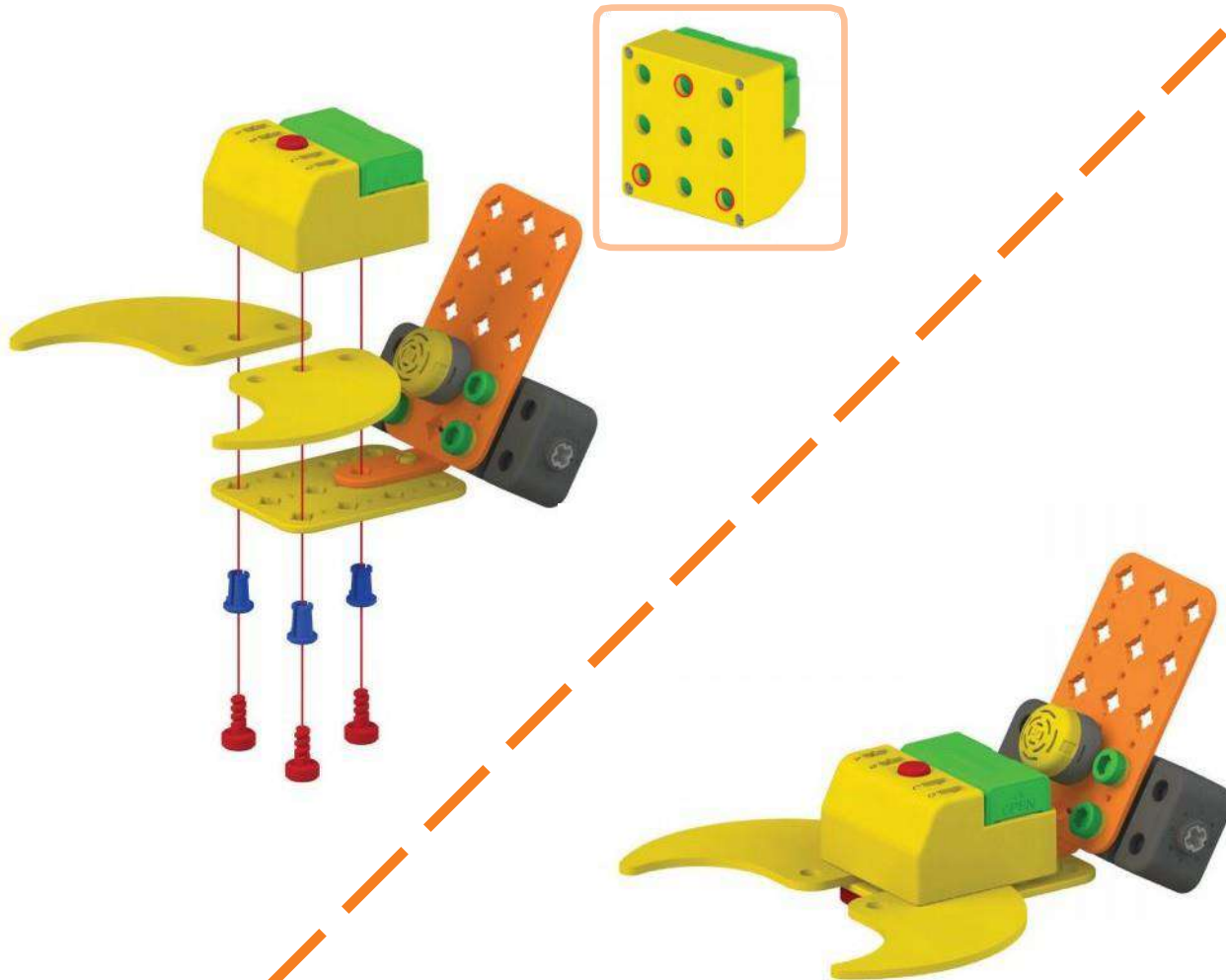

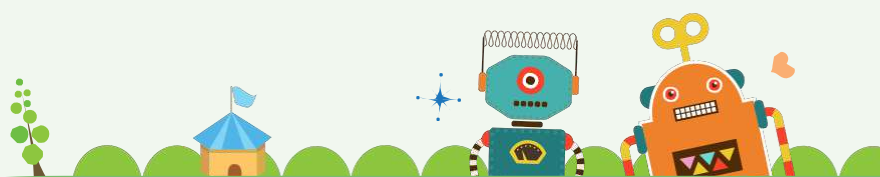

5

Детали



x4



x2



x2

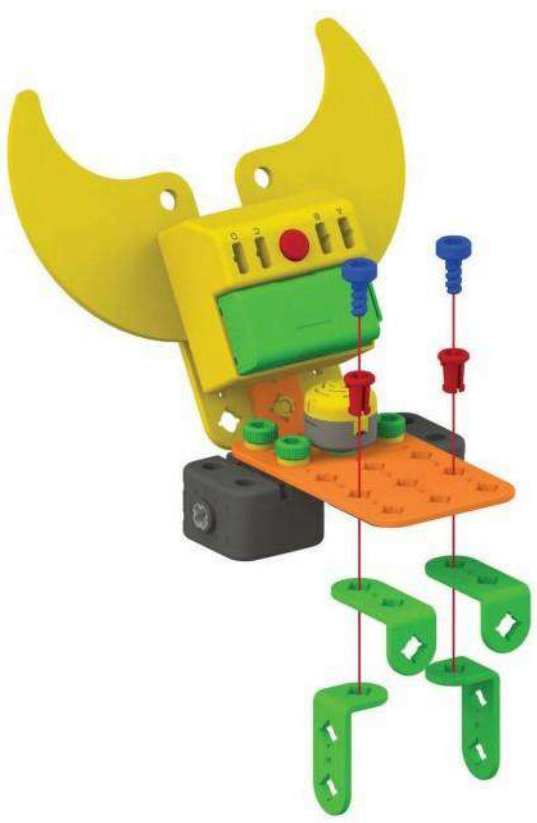

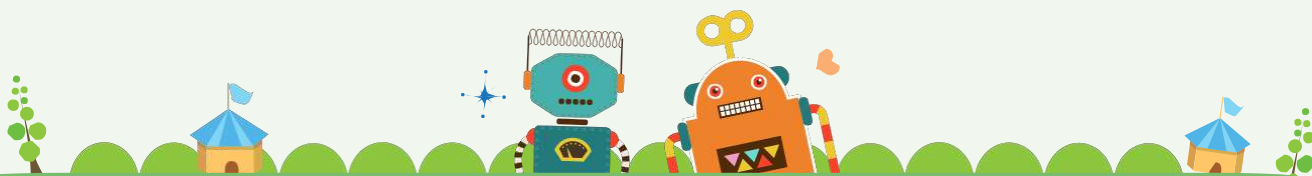

6

Детали



x1



x2



x2

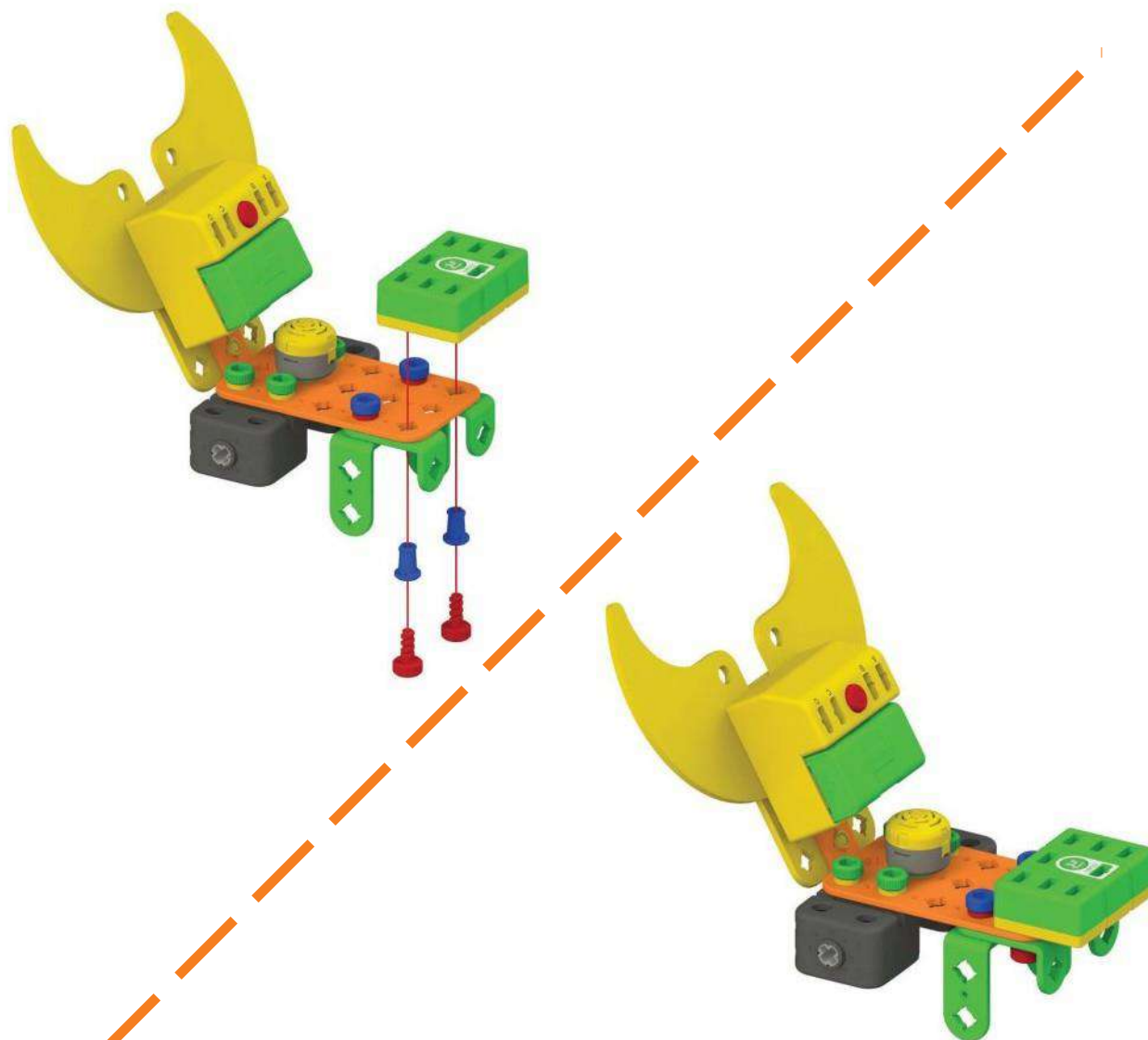

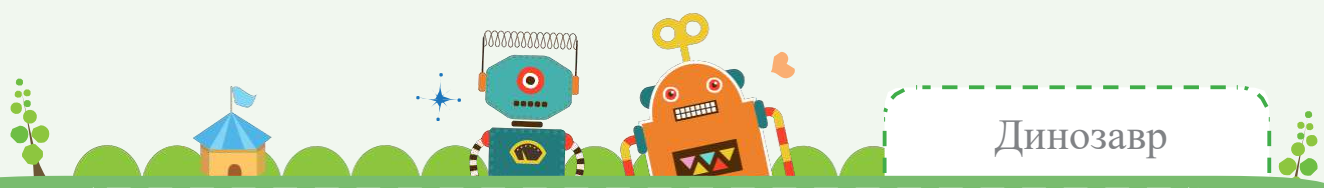

Детали



x1



x2



x2



x2

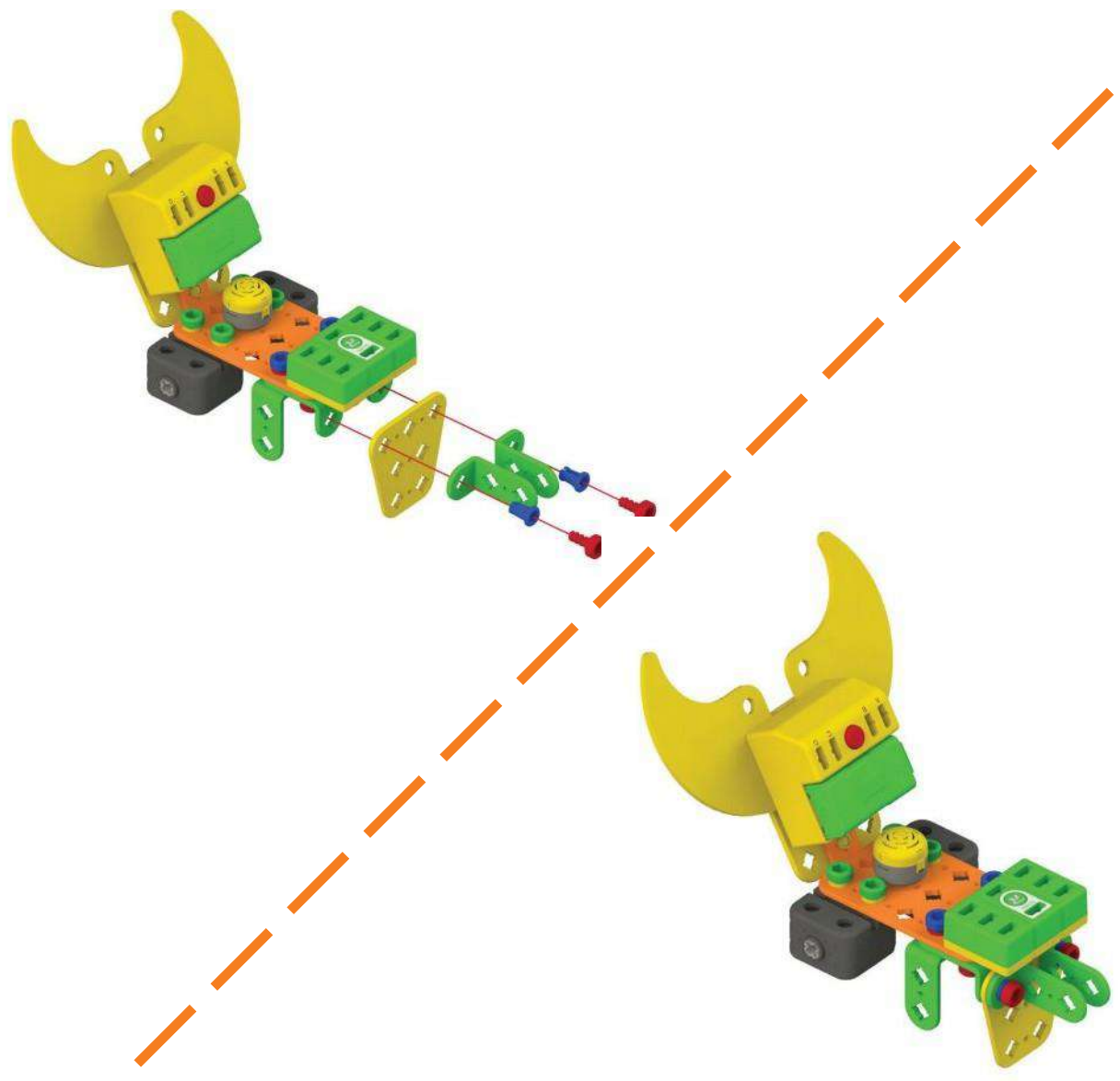

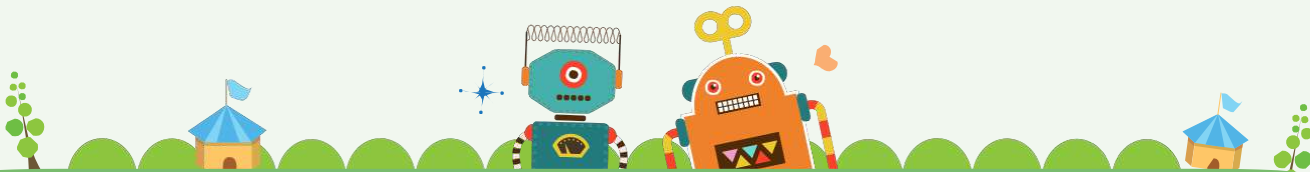

87

Детали



x2



x2



x2



x2

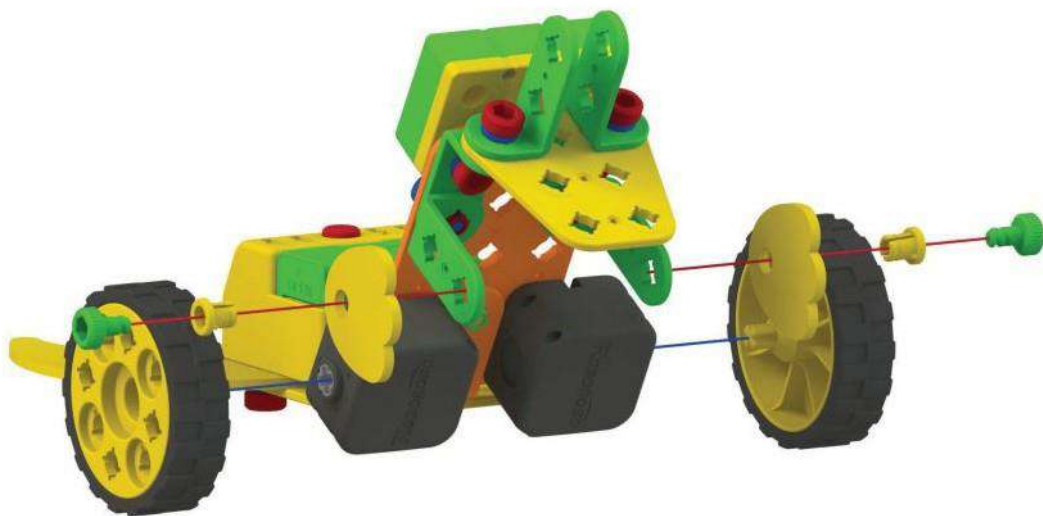

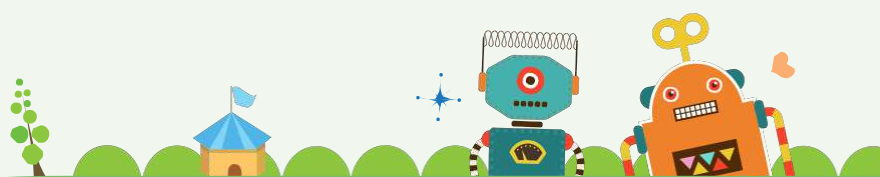

9

Детали



x2



x1



x2



x2



x1



x1

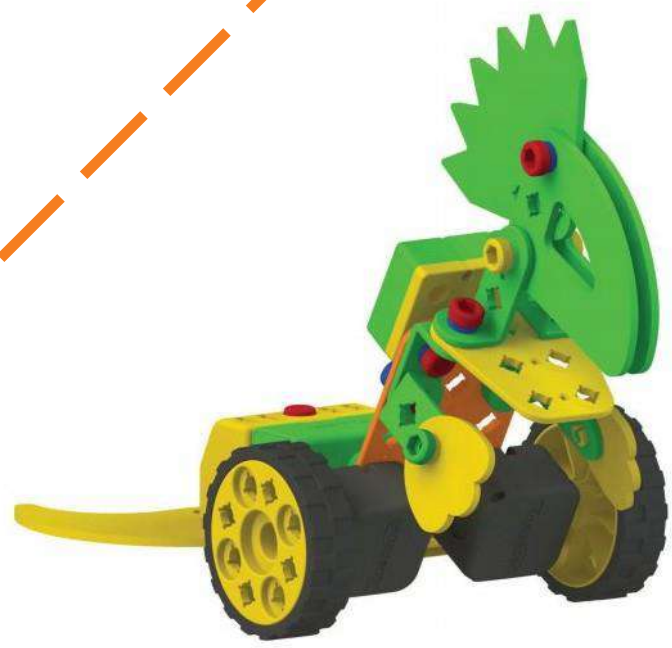
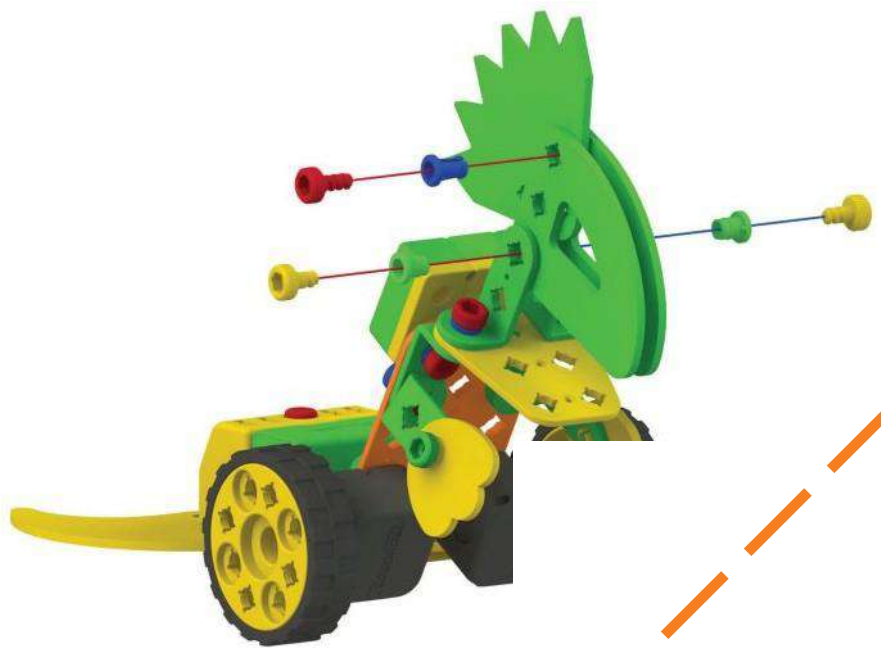

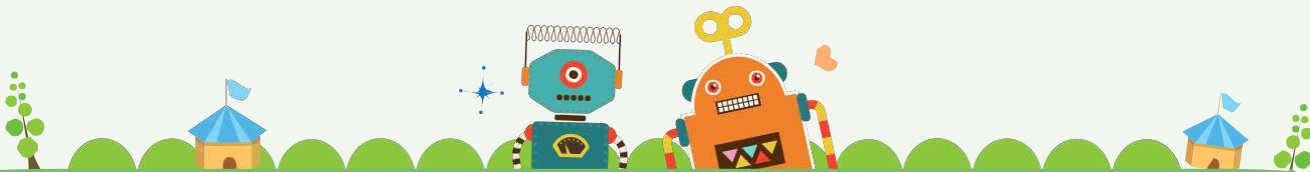

Детали



x1



x1

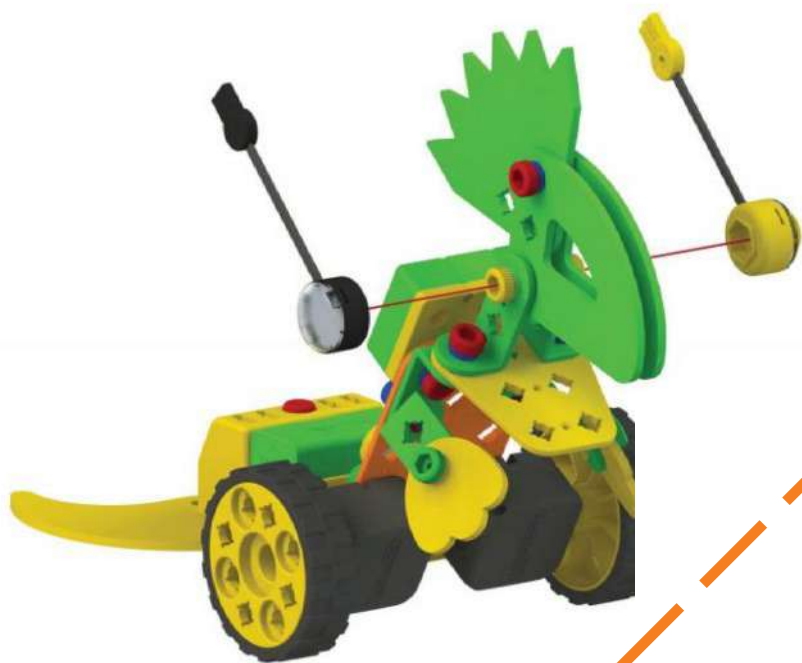



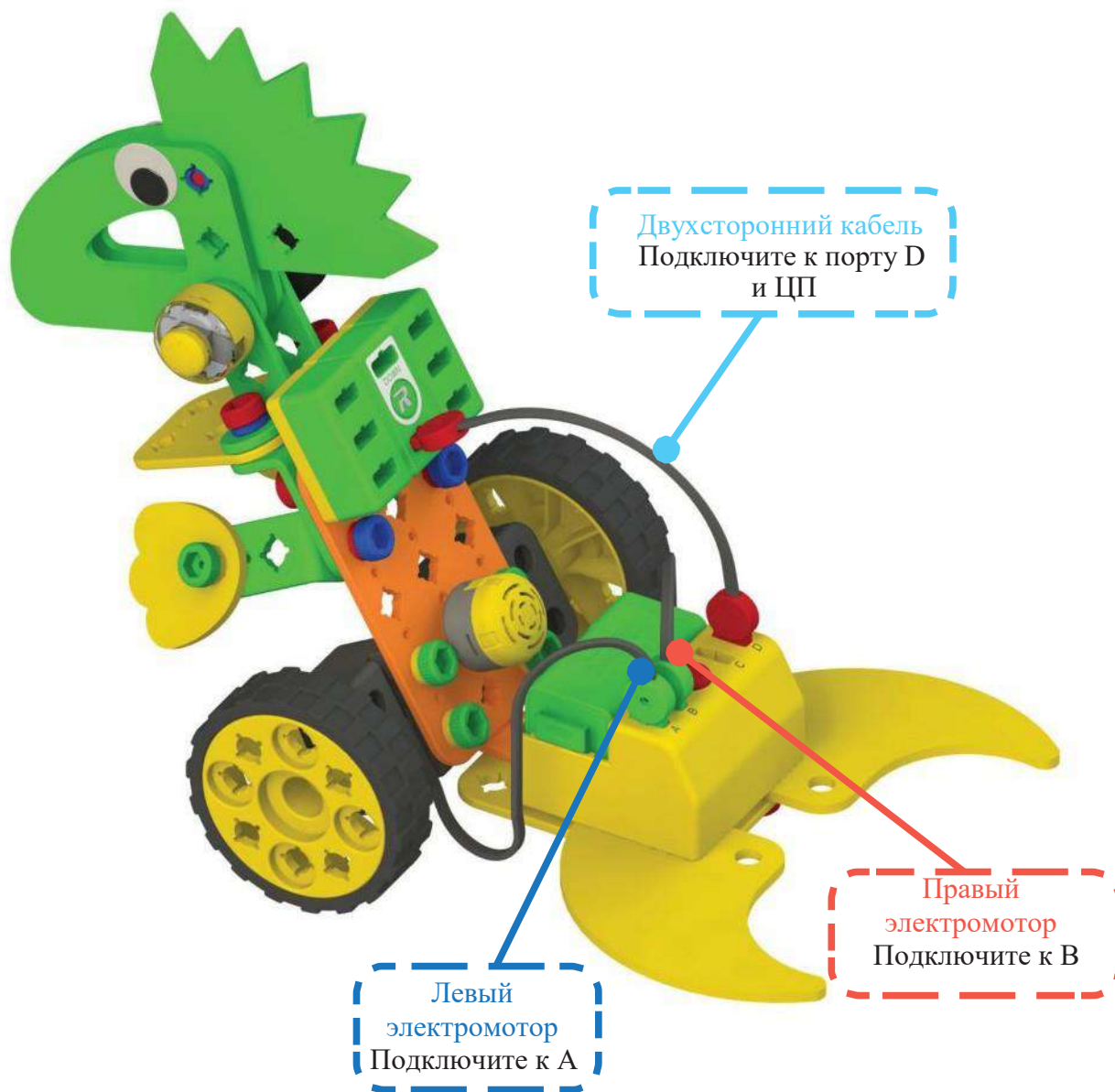

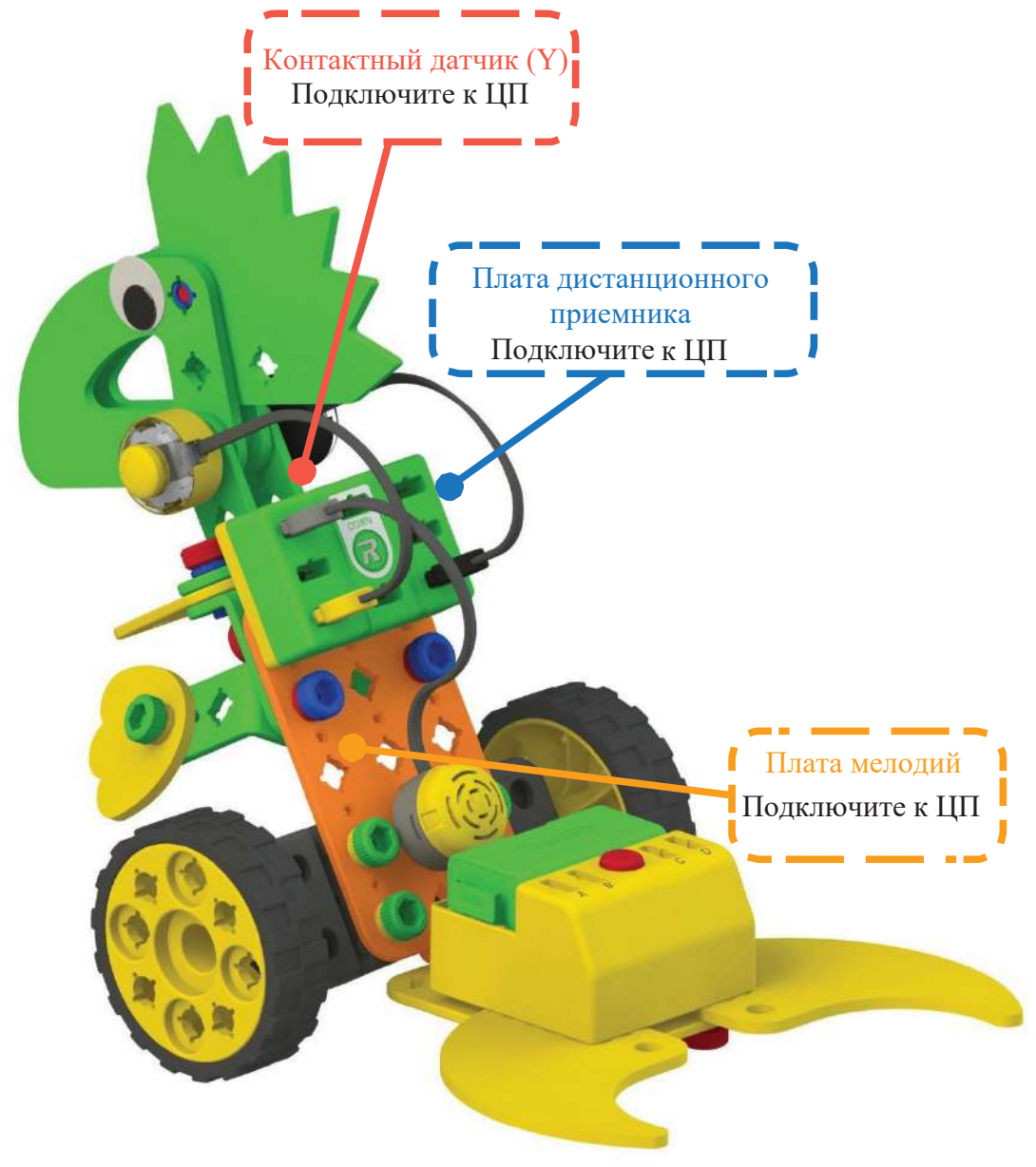
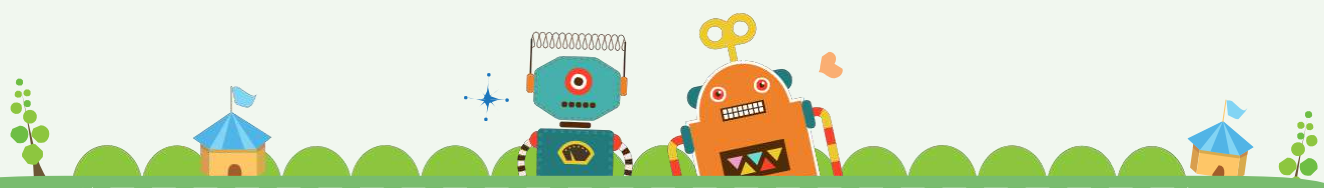

Контактный датчик (У)  
Подключите к ЦП

Плата дистанционного  
приемника  
Подключите к ЦП

Плата мелодий  
Подключите к ЦП

Создадим  
Программу

Запрограммируем движение робота  
динозавра на программной плате.



Управляйте динозавром с помощью устройства  
дистанционного управления



Сыграем с Рино!



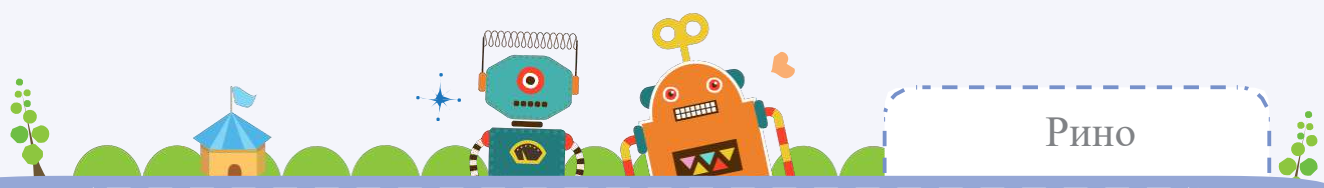

Детали



x1



x2



x2



x2

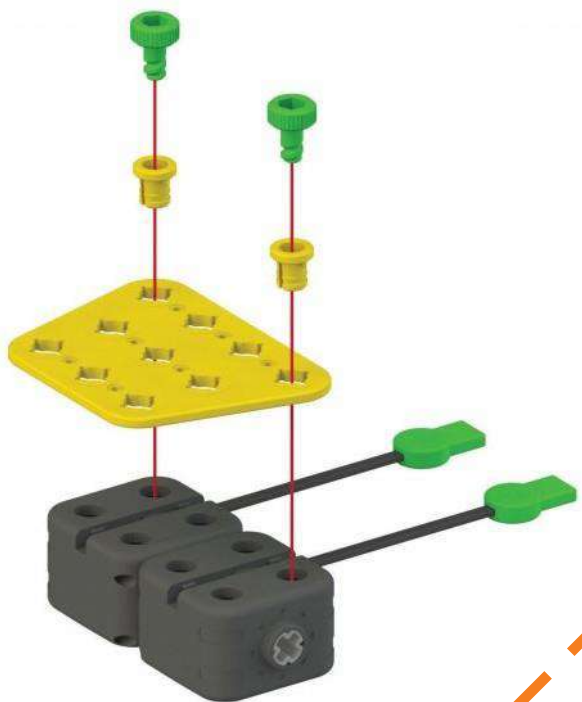

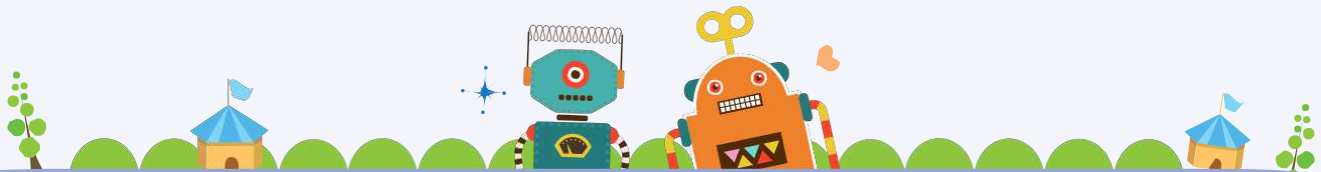

2

Детали



x1



x2



x2

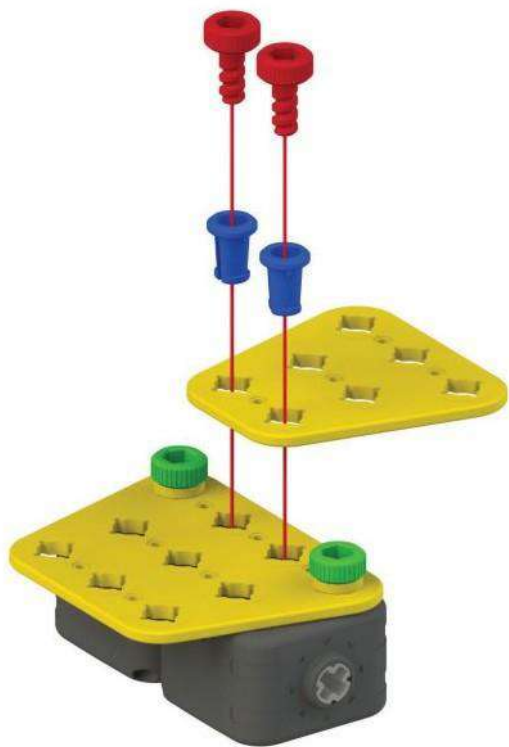

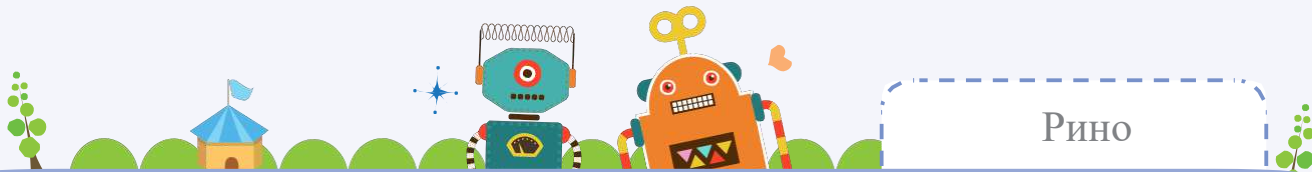

Рино

3

Детали



x1



x1



x2



x2

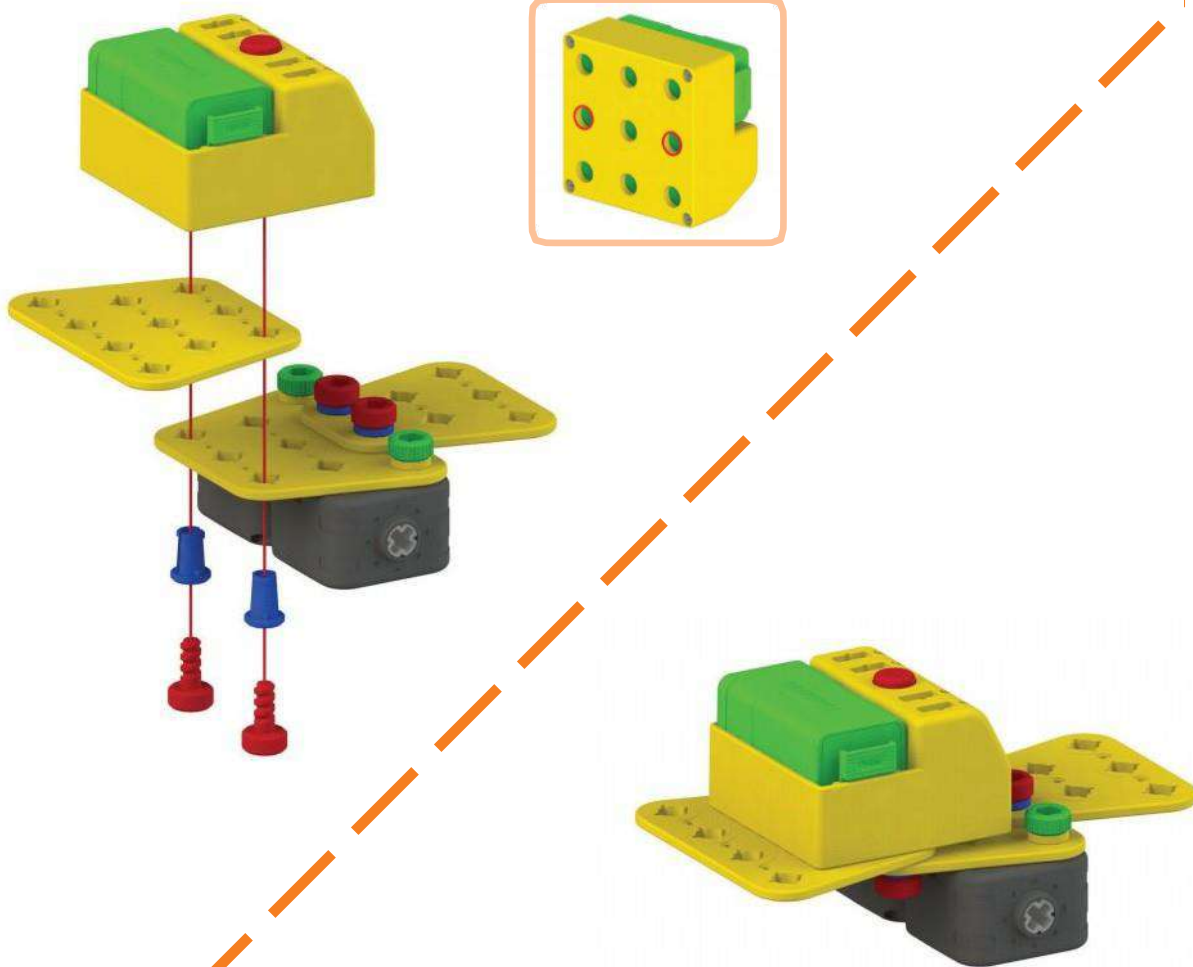

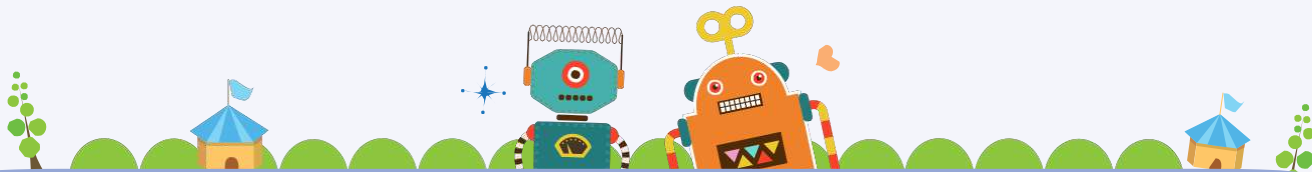

4

Детали



x1



x2



x2

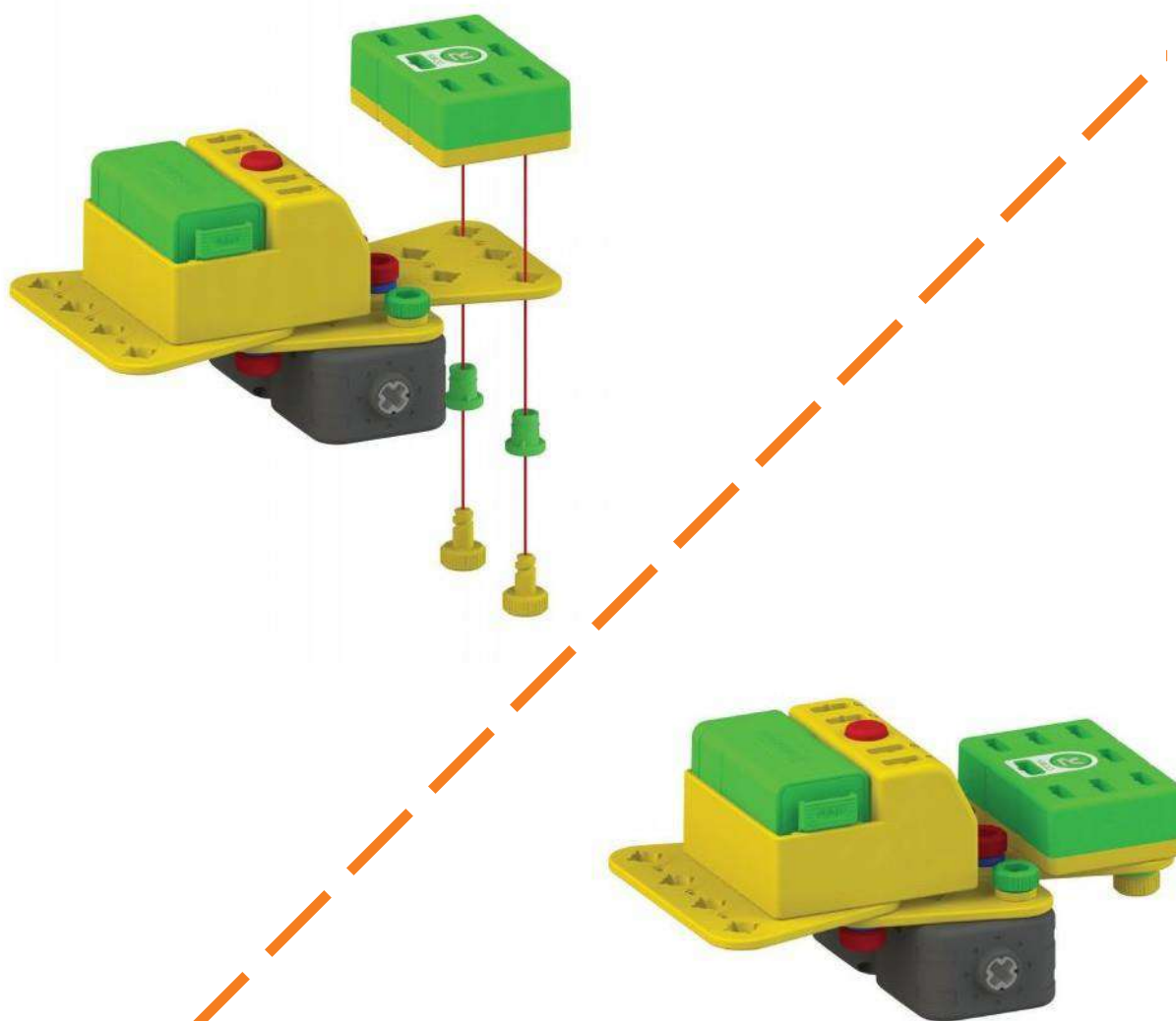



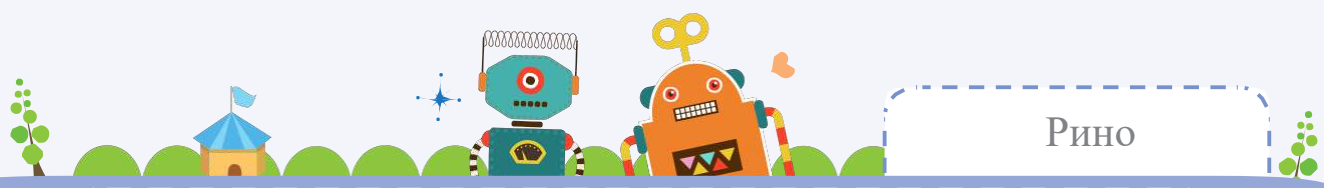

5

Детали



x2



x2



x2

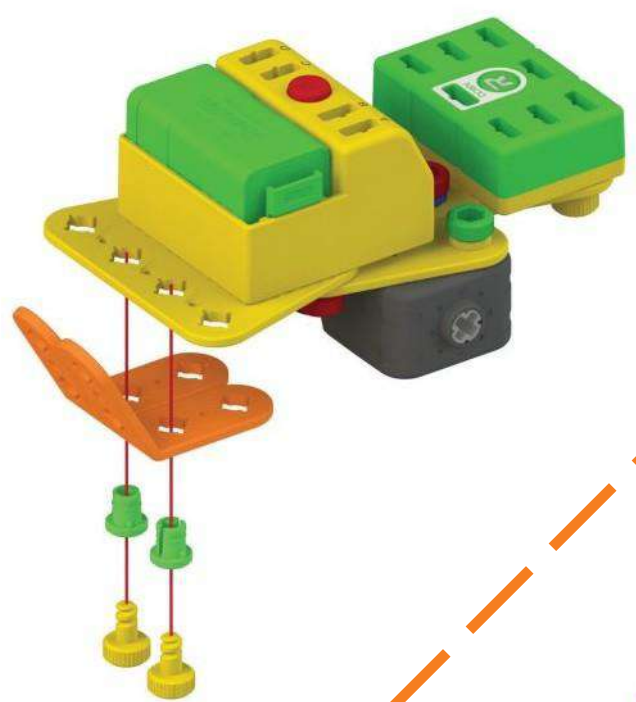

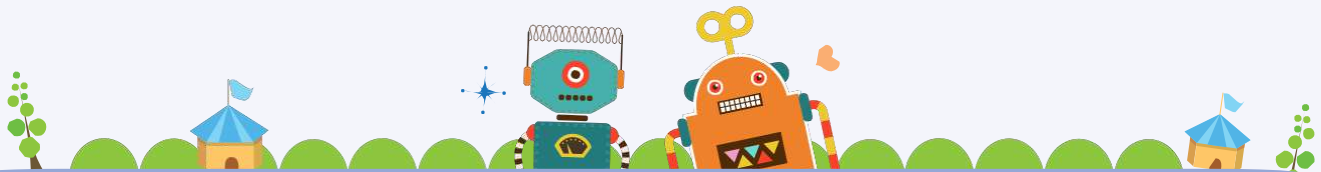

6

Детали



x1



x2



x2



x2

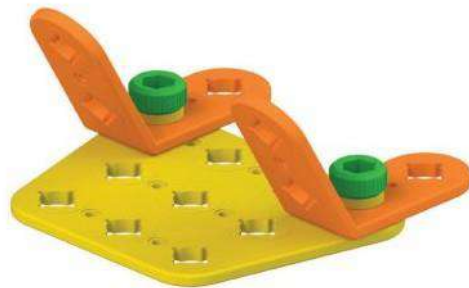
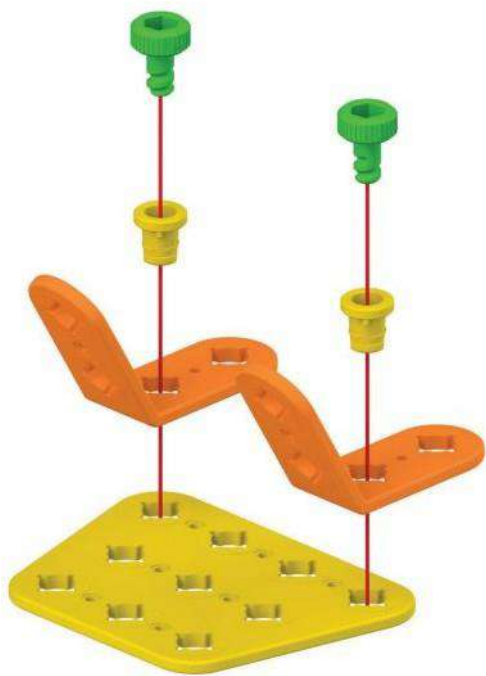

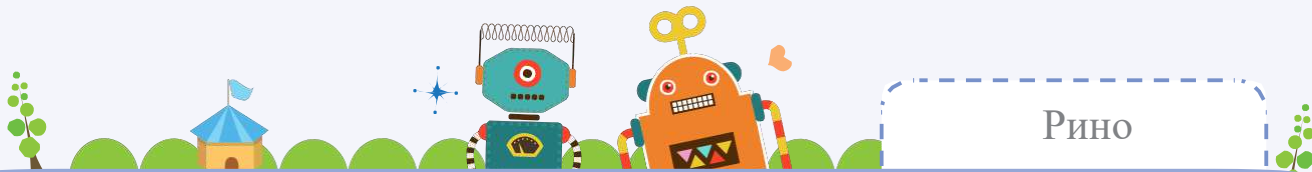

Детали



x1



x1



x3



x3

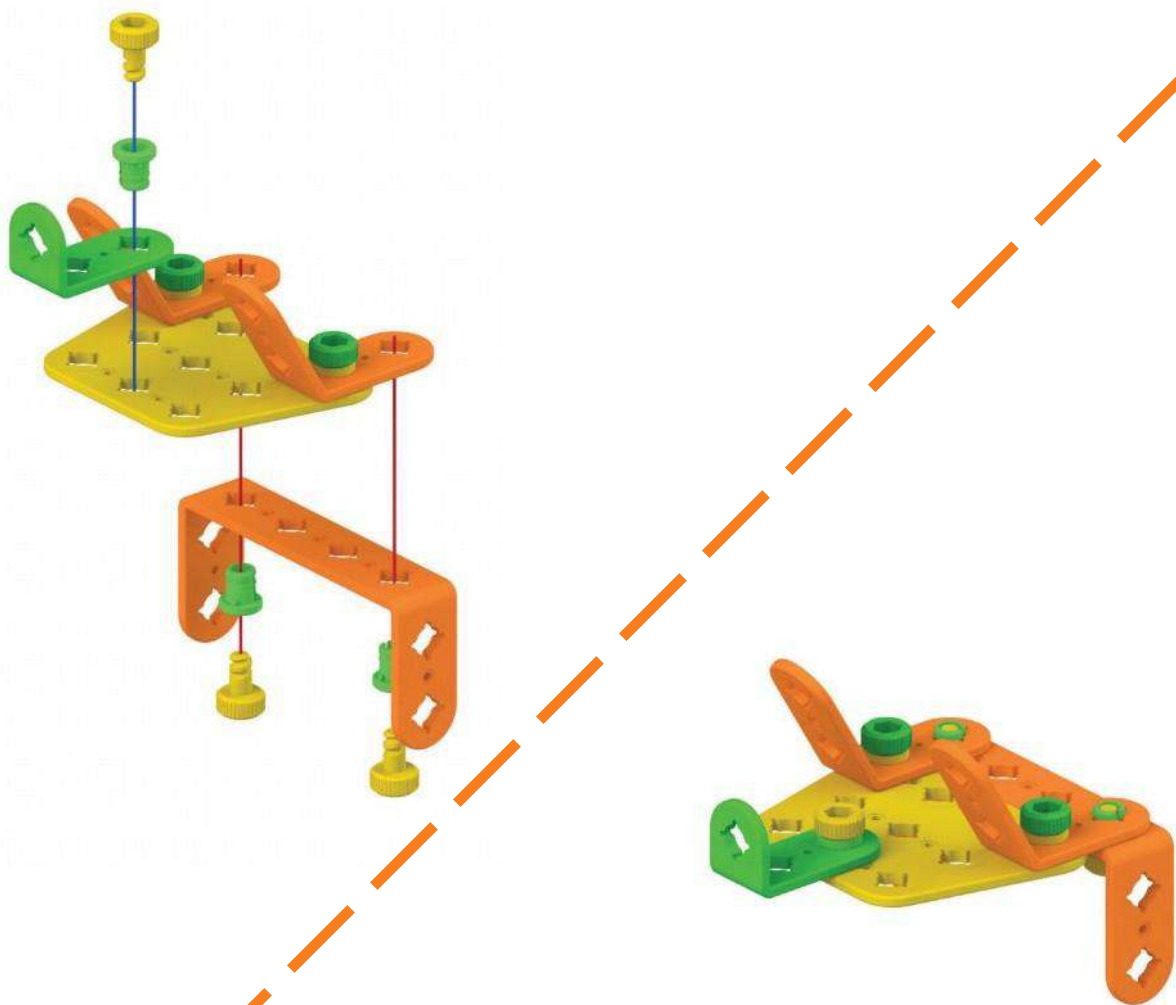

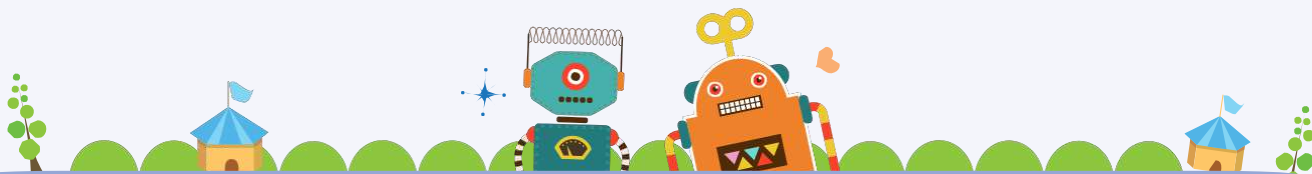

8

Детали



x1



x2



x4



x4

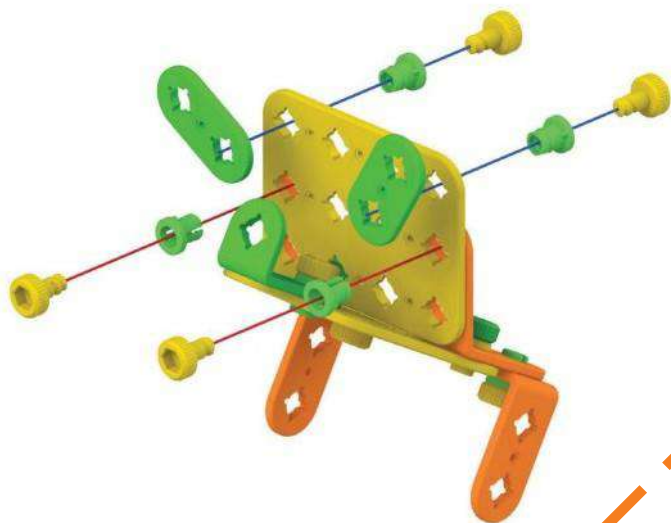

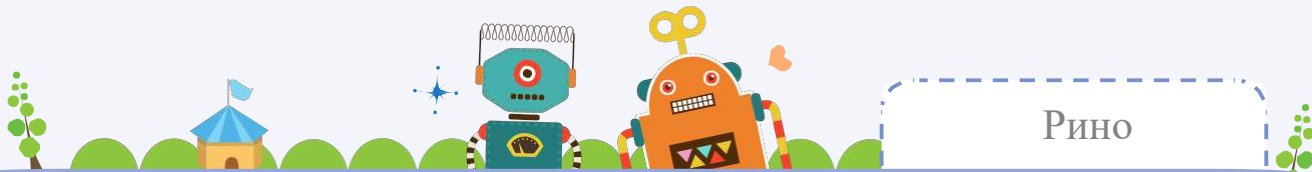

9 Детали



x2



x2

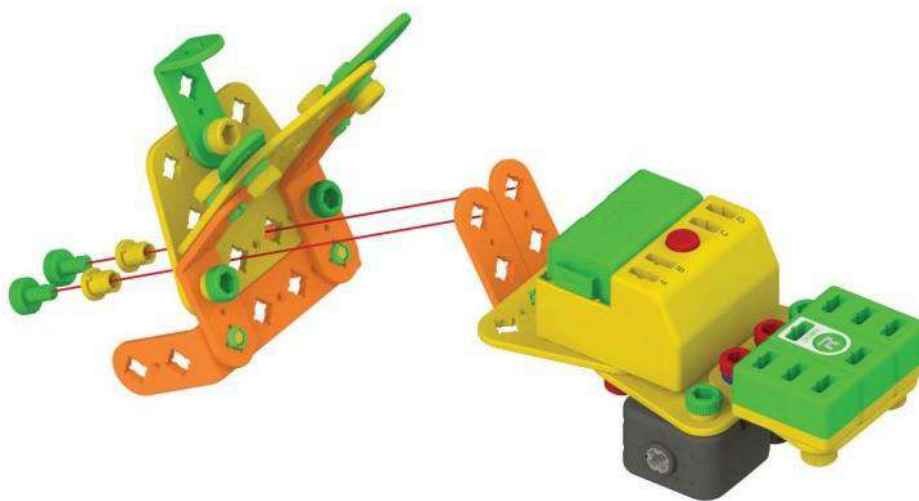

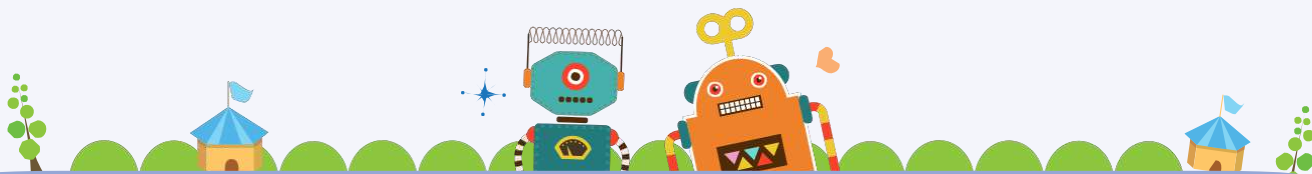

10

Детали



x2



x2



x2



x2

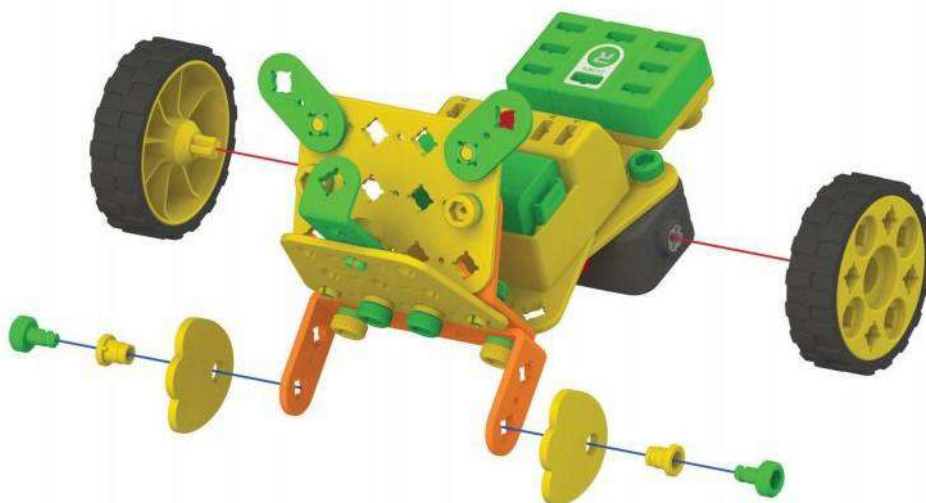

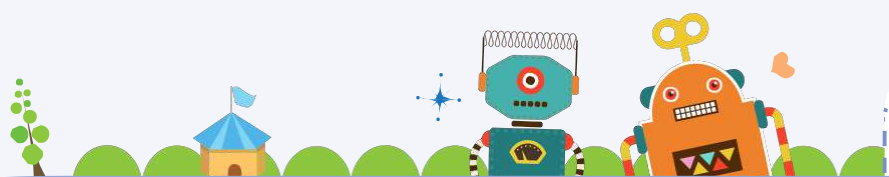

Детали



x1



x1



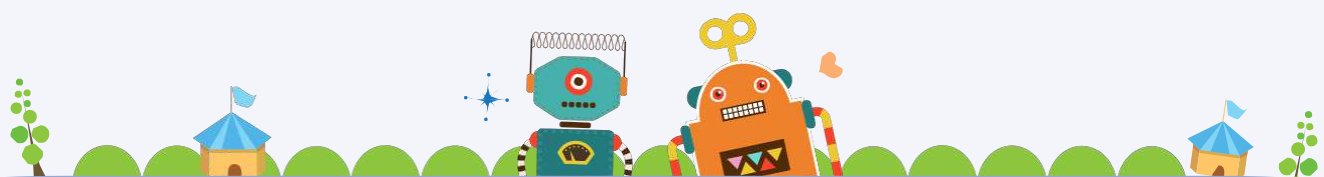

Двухсторонний кабель  
Подключите к порту D и ЦП

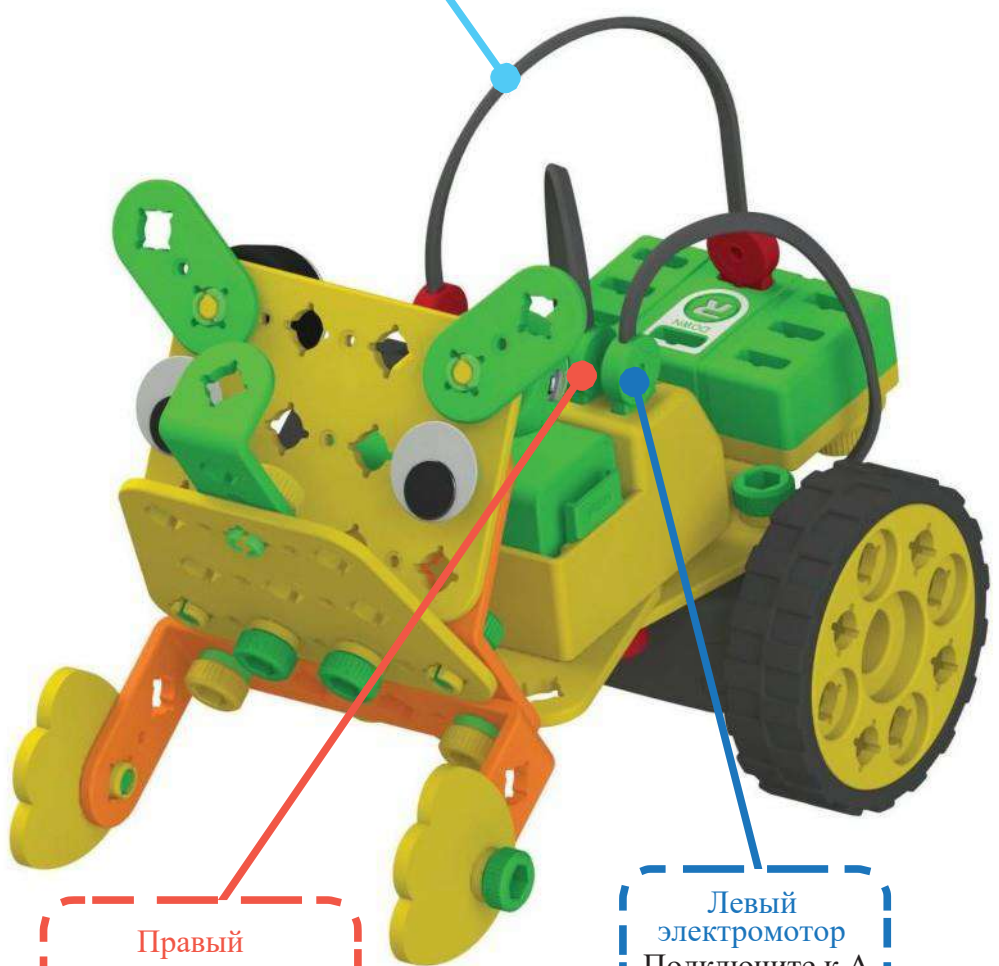

Правый  
электромотор  
Подключите к B

Левый  
электромотор  
Подключите к A



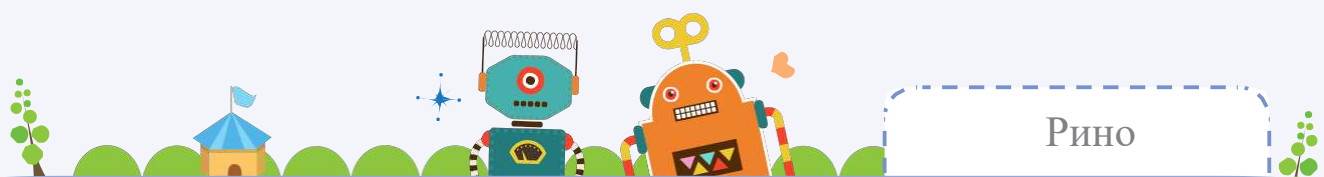

Плата дистанционного приемника  
Подключите к ЦП

Контактный датчик (G)  
Подключите к ЦП

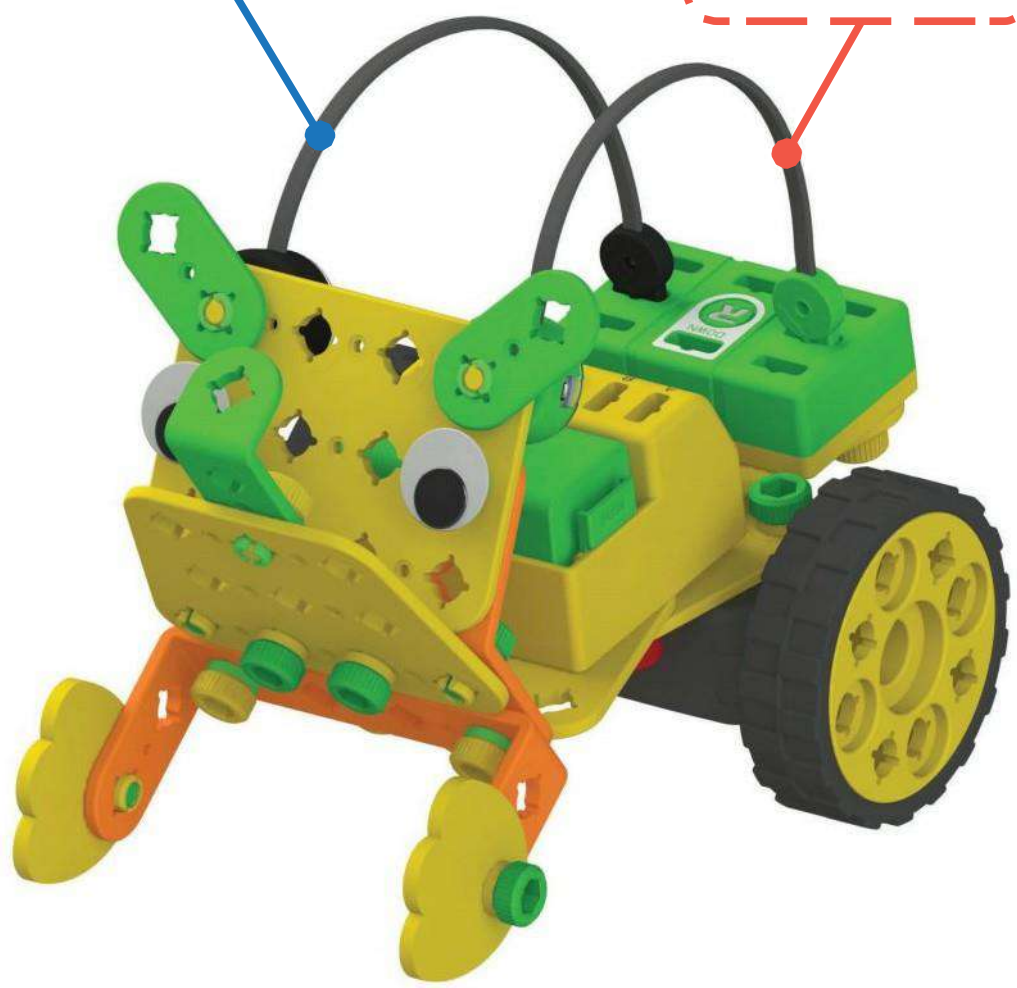



Запрограммируем движение робота Рино на программной плате.



Управляйте Рино с помощью устройства дистанционного управления

8-й



Сыграем с музыкальной куклой!

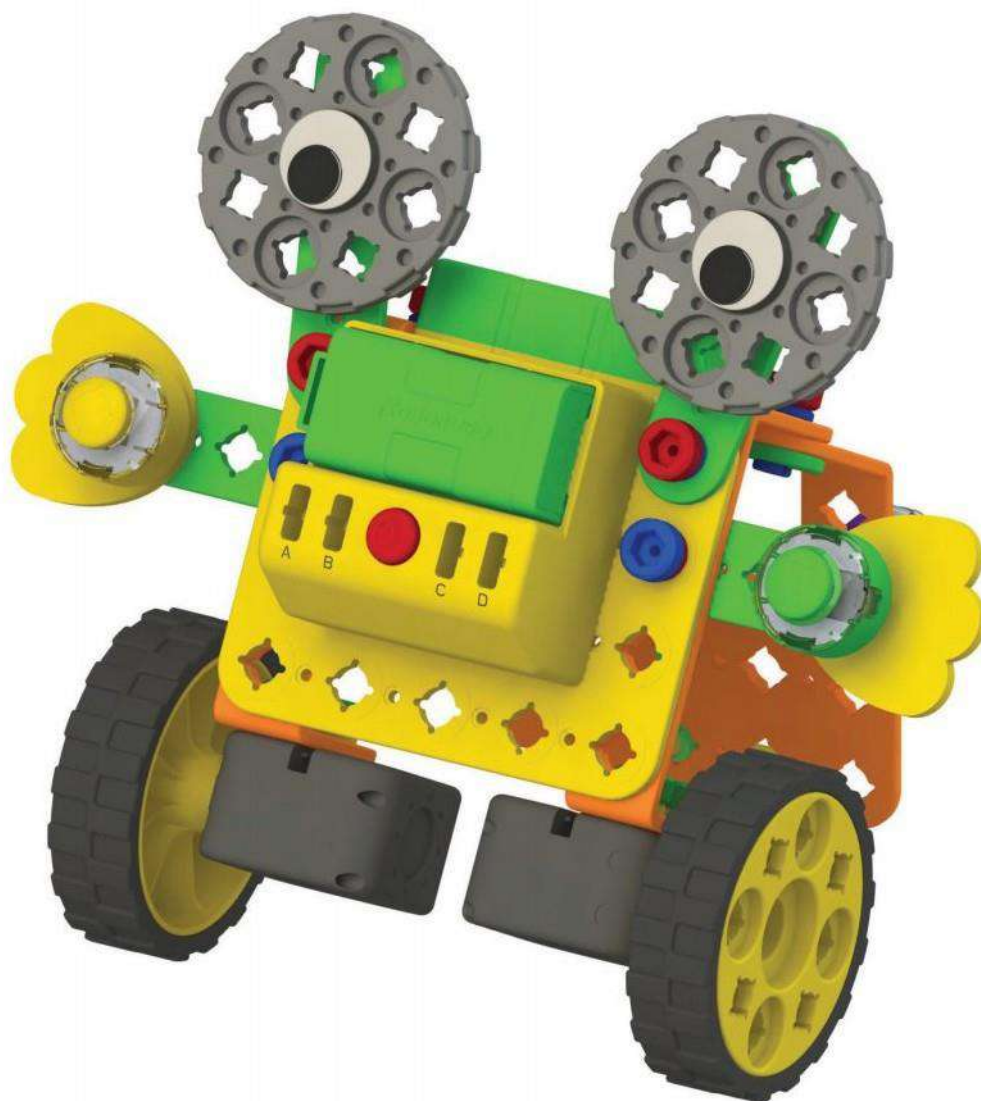

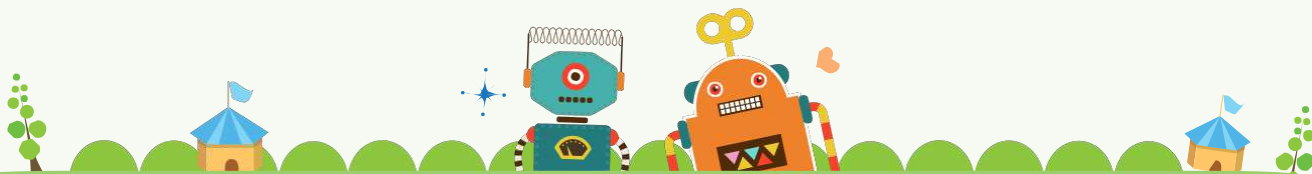

## Детали



x2



x2



x4



x4

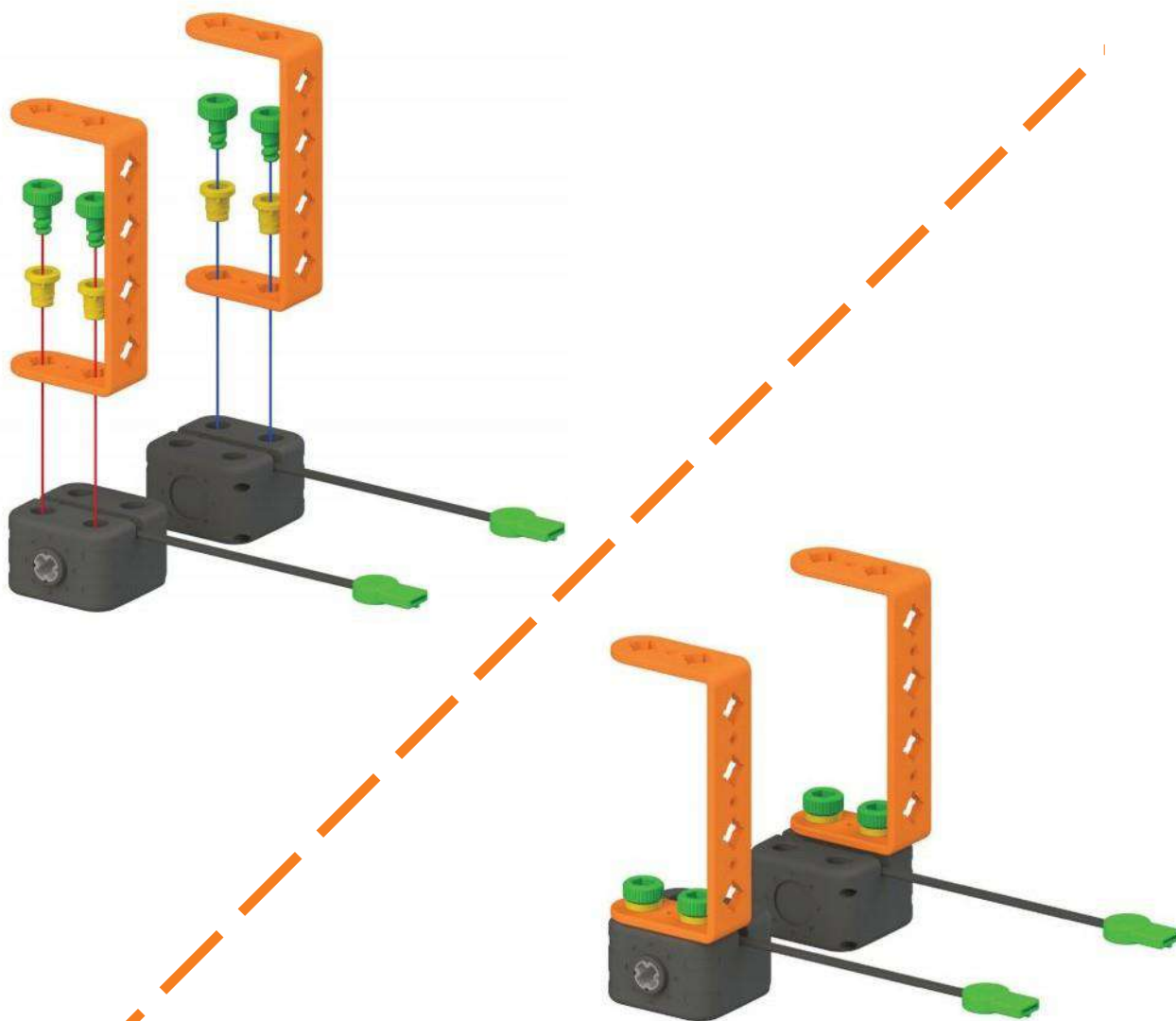

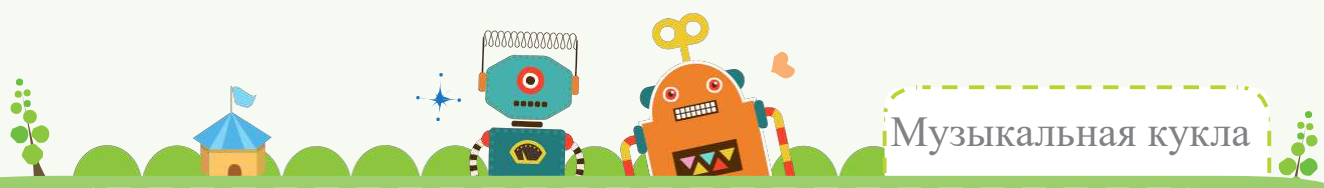

2 Детали

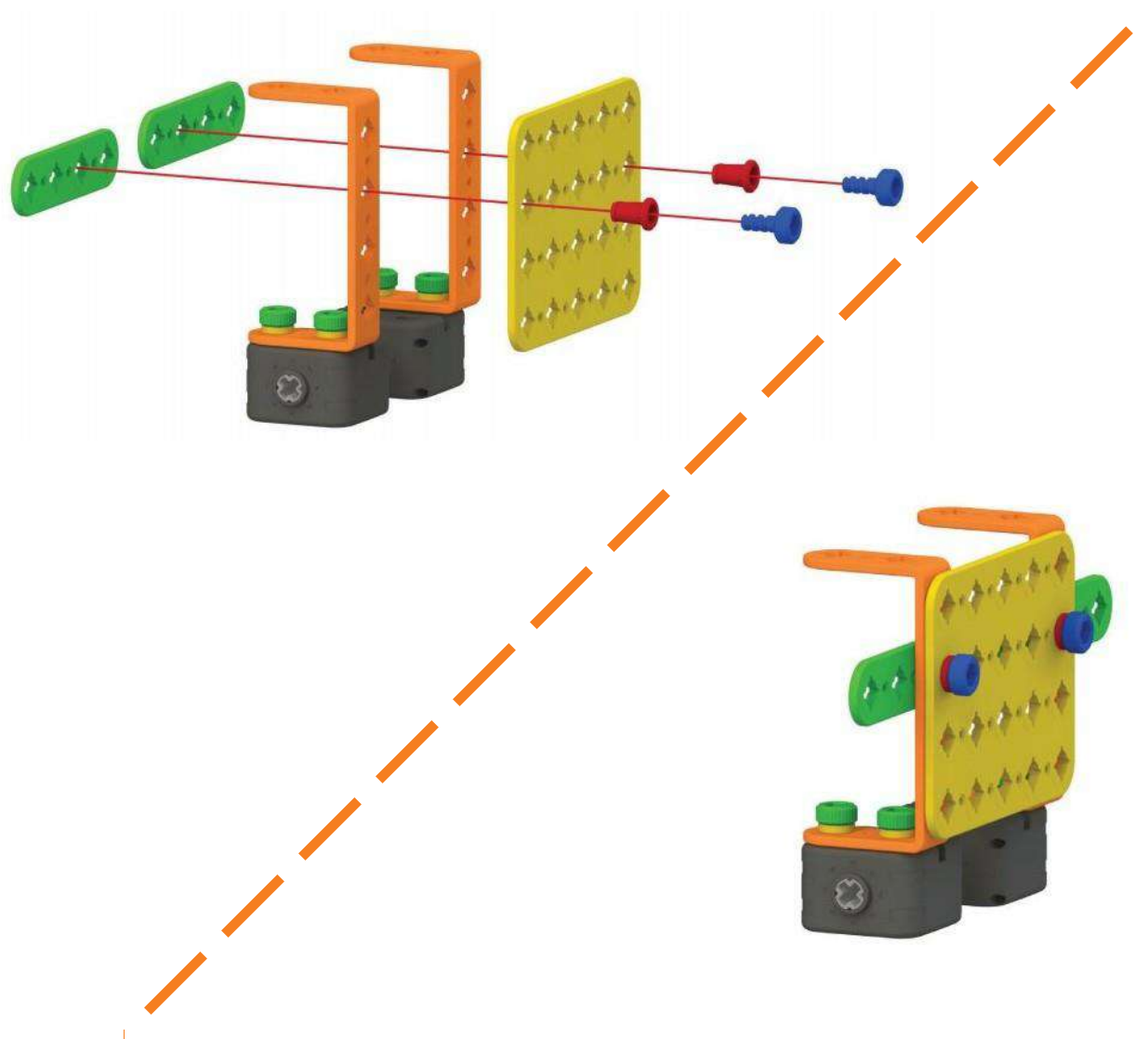
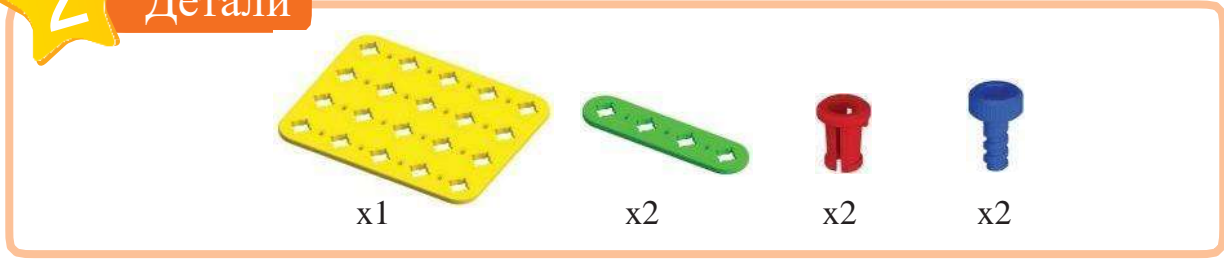

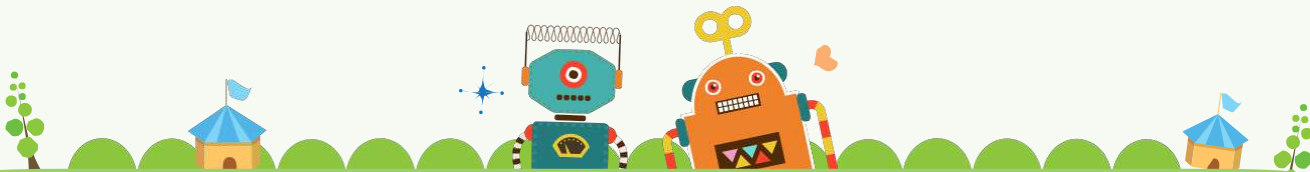

3

Детали



x2



x2



x2

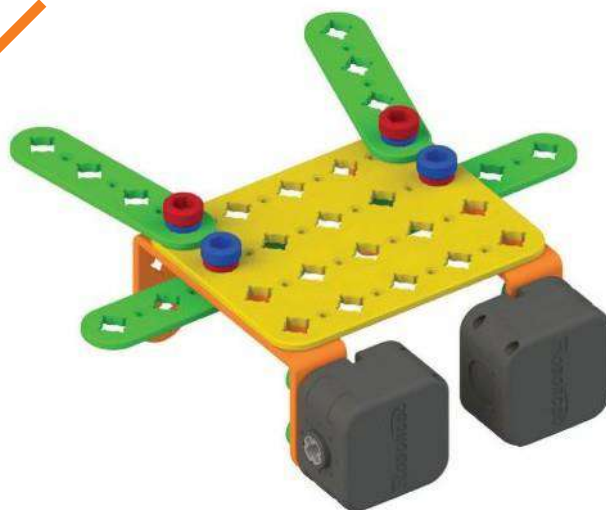
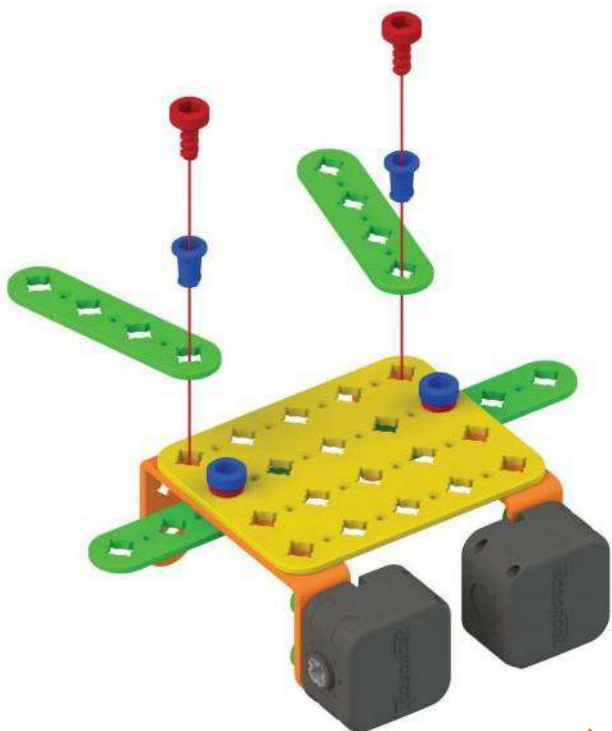

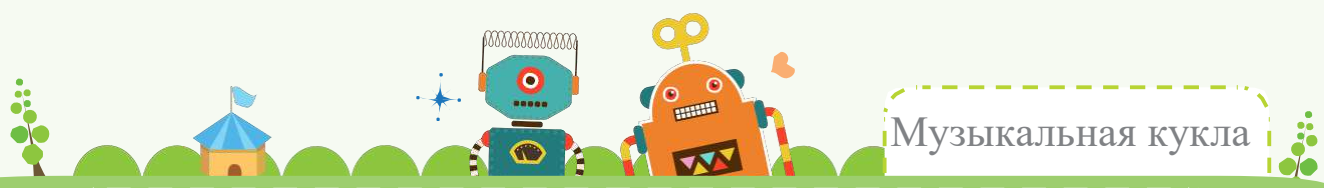

4 Детали



x2



x2



x2



x2



x2



x2

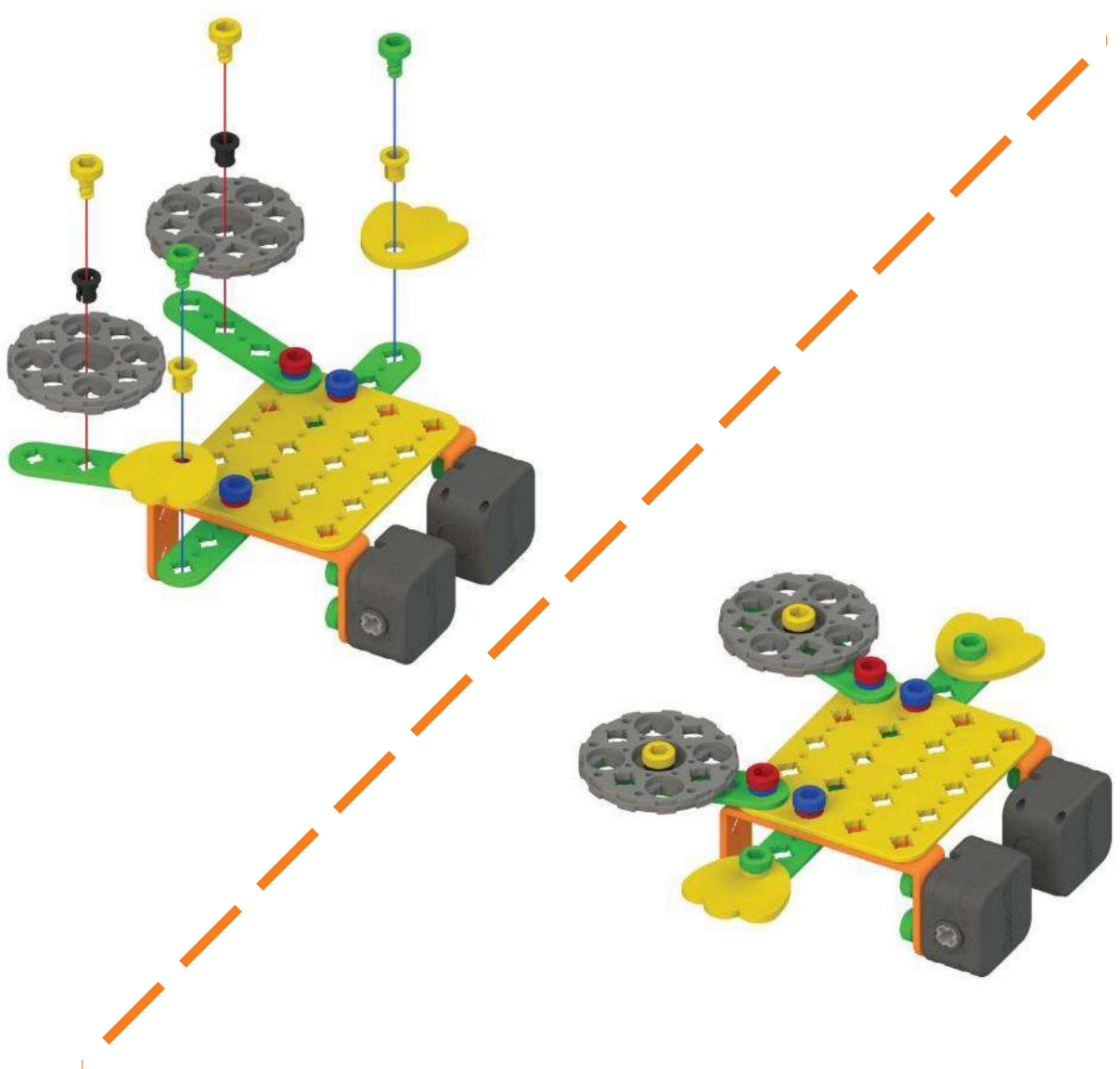

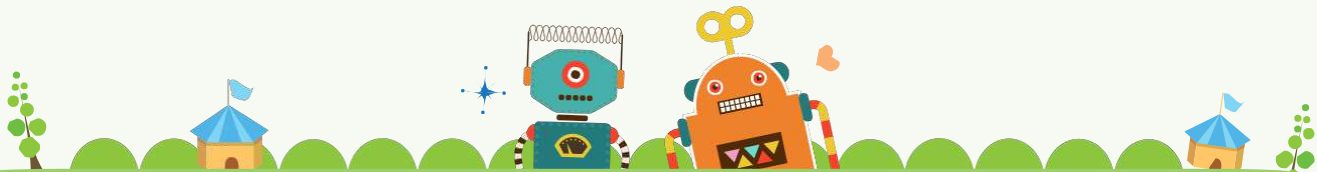

5

Детали



x1



x2



x2

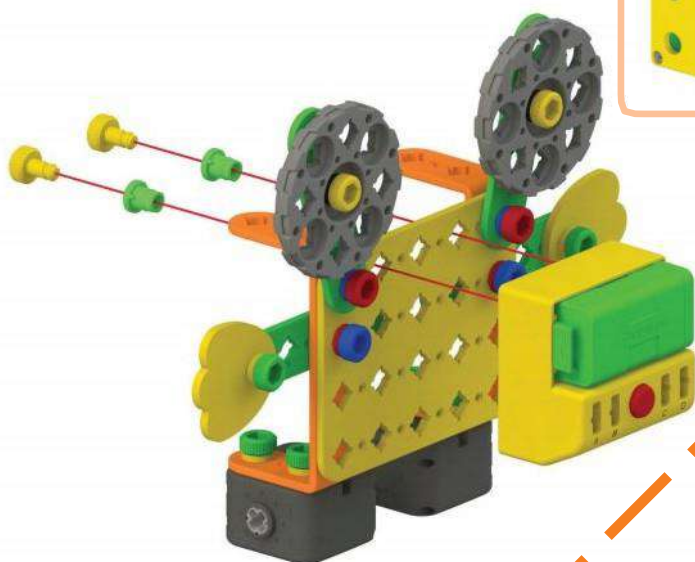



6

Детали



x1



x1



x2



x2

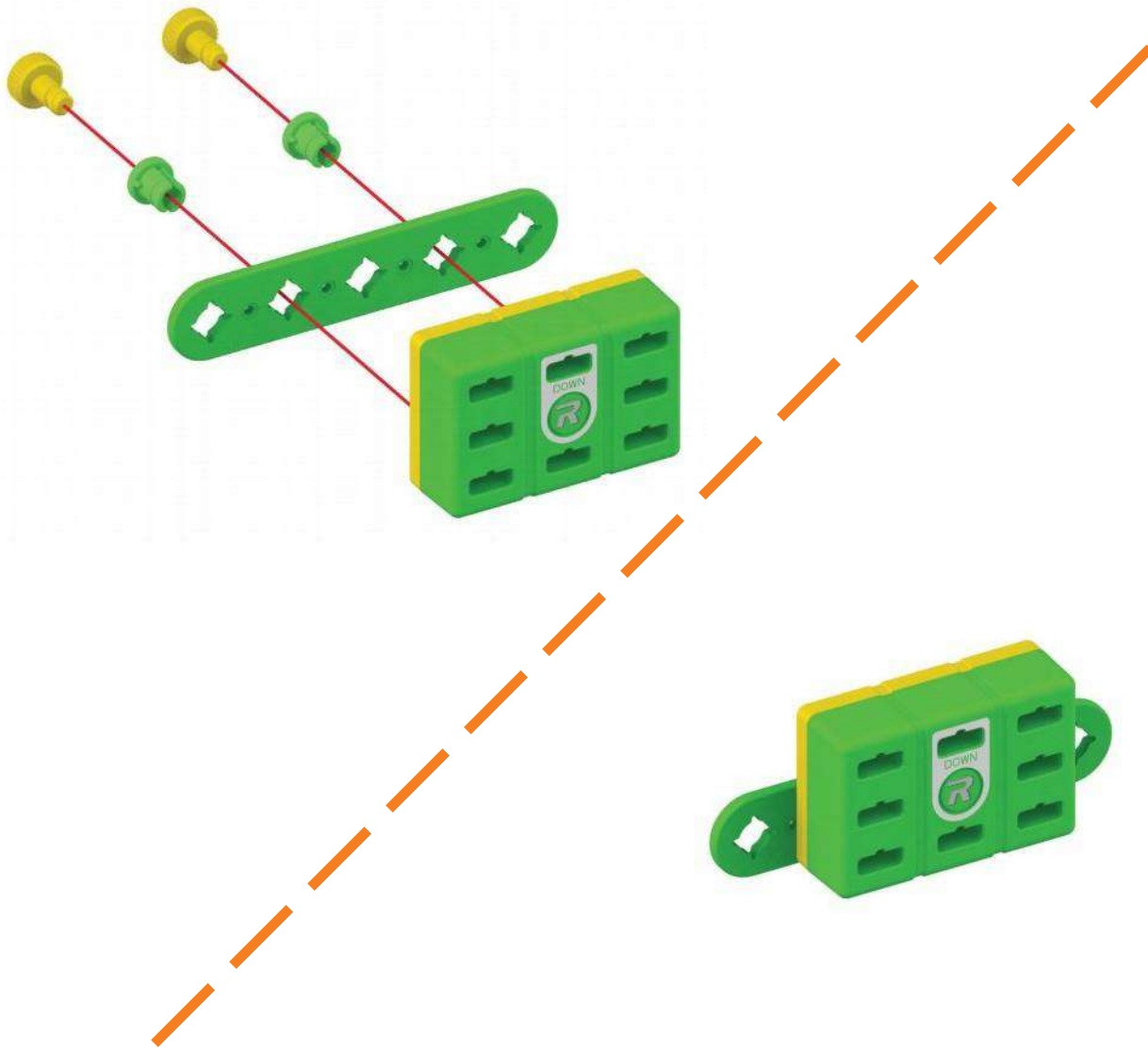

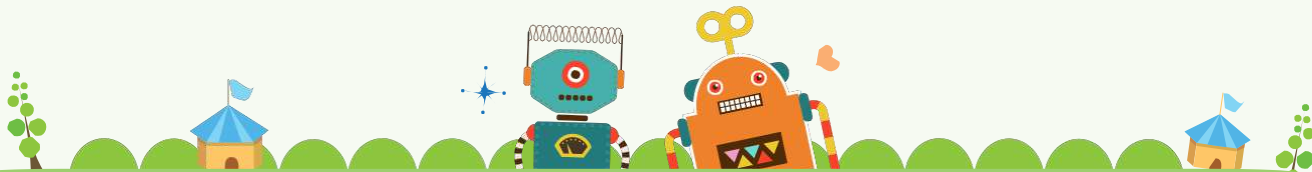

Детали



x2



x2



x2

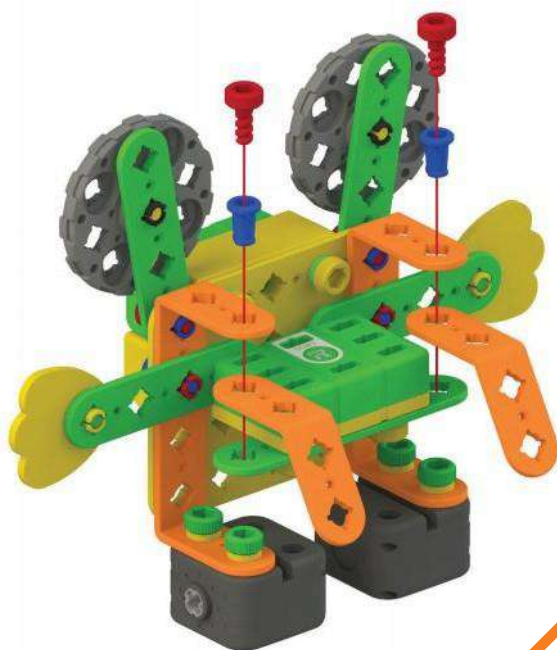

8

Детали



x1



x2



x2

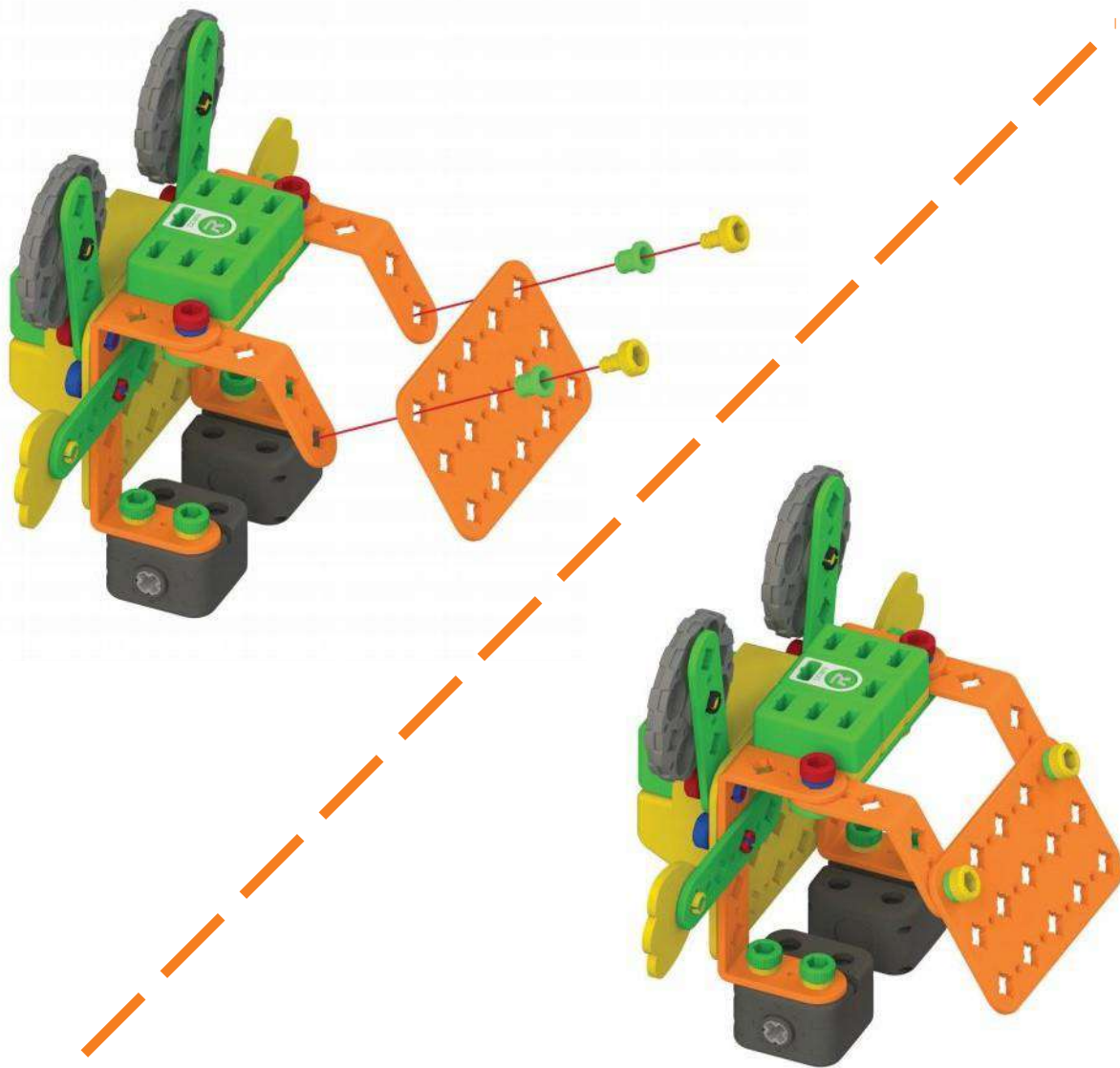

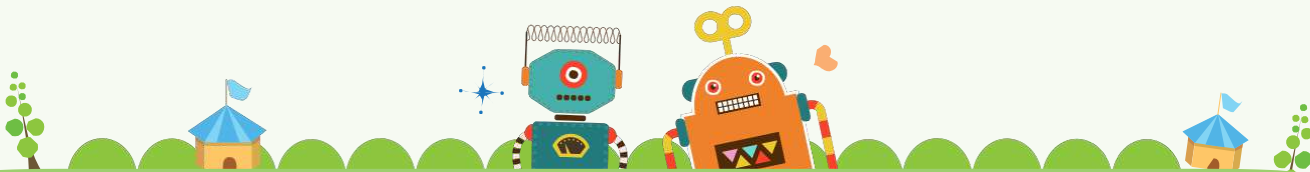

9

Детали



x1



x1



x1



x2



x2

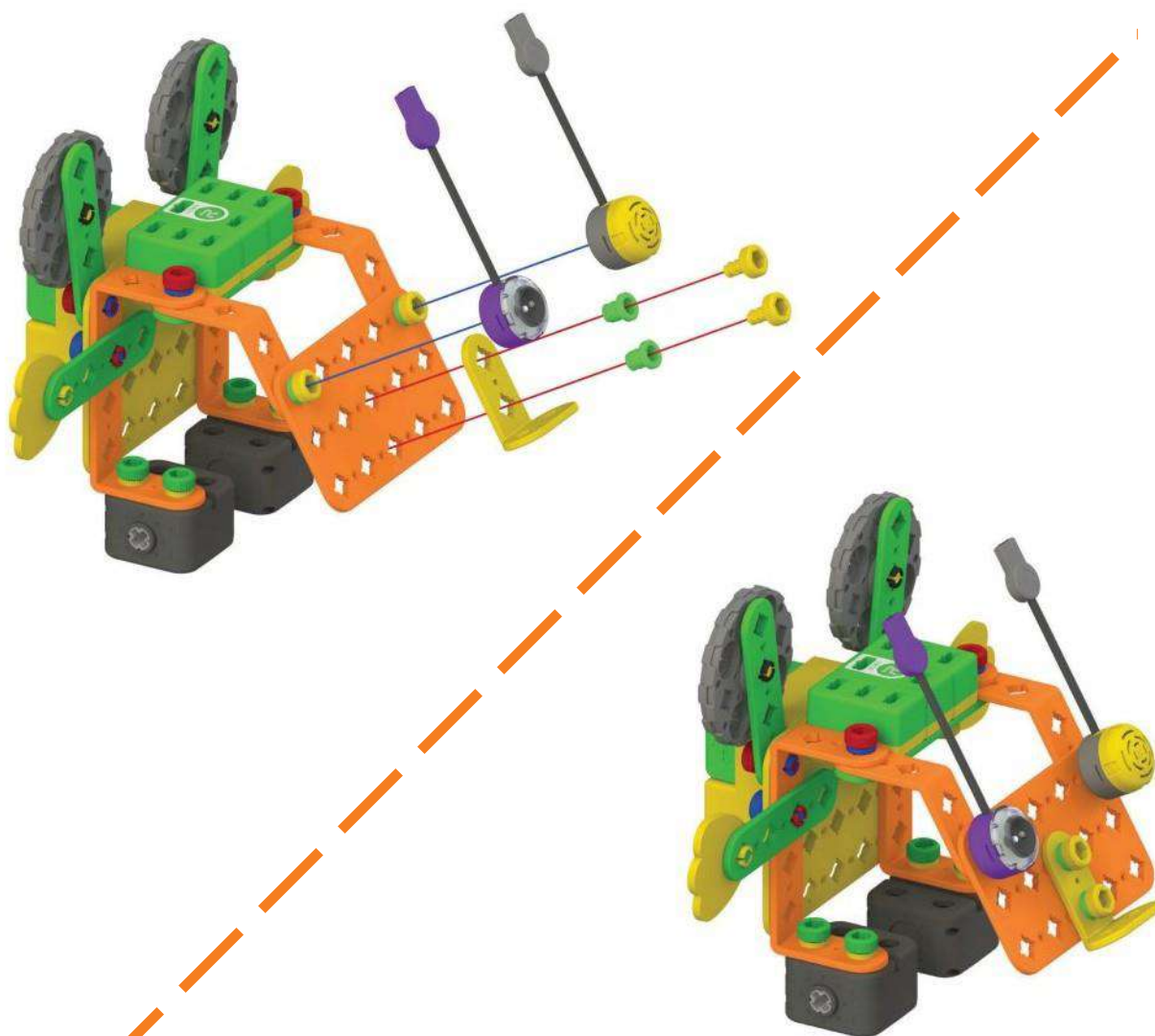

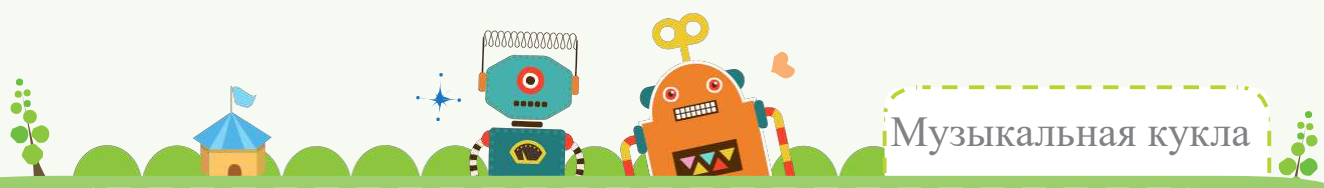

10 Детали



x2



x1



x1

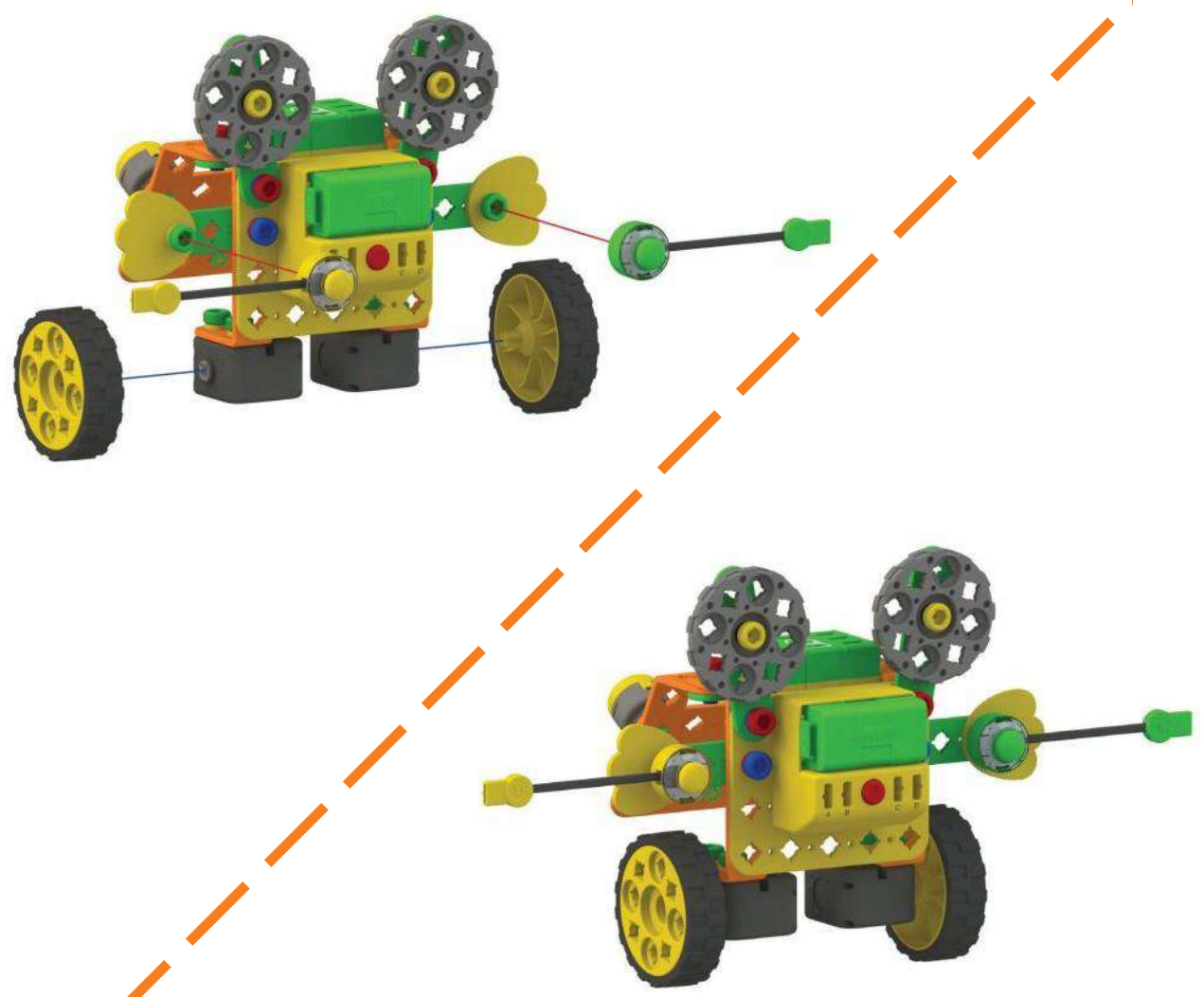

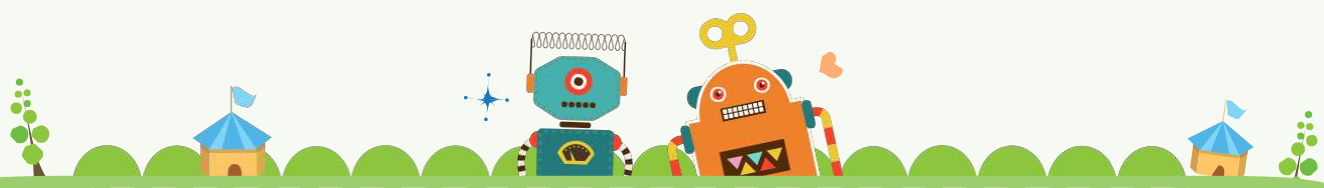

Двухсторонний кабель

Подключите к порту D и ЦП

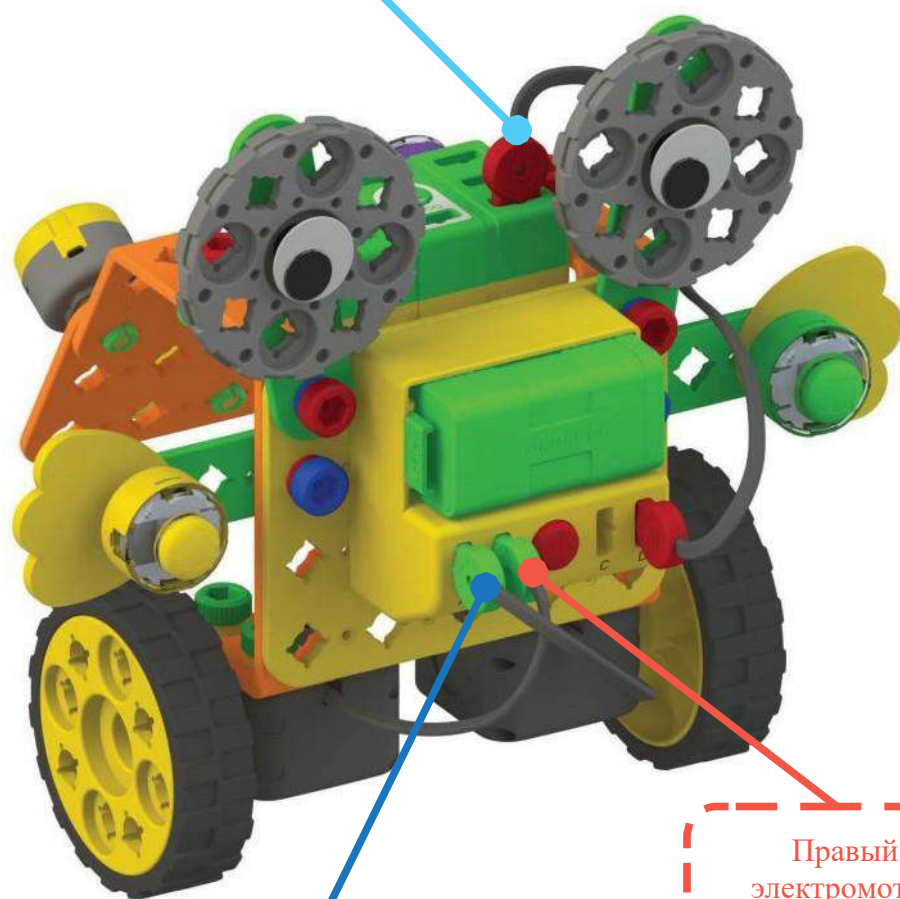

Левый  
электромотор  
Подключите к А

Правый  
электромотор  
Подключите к В

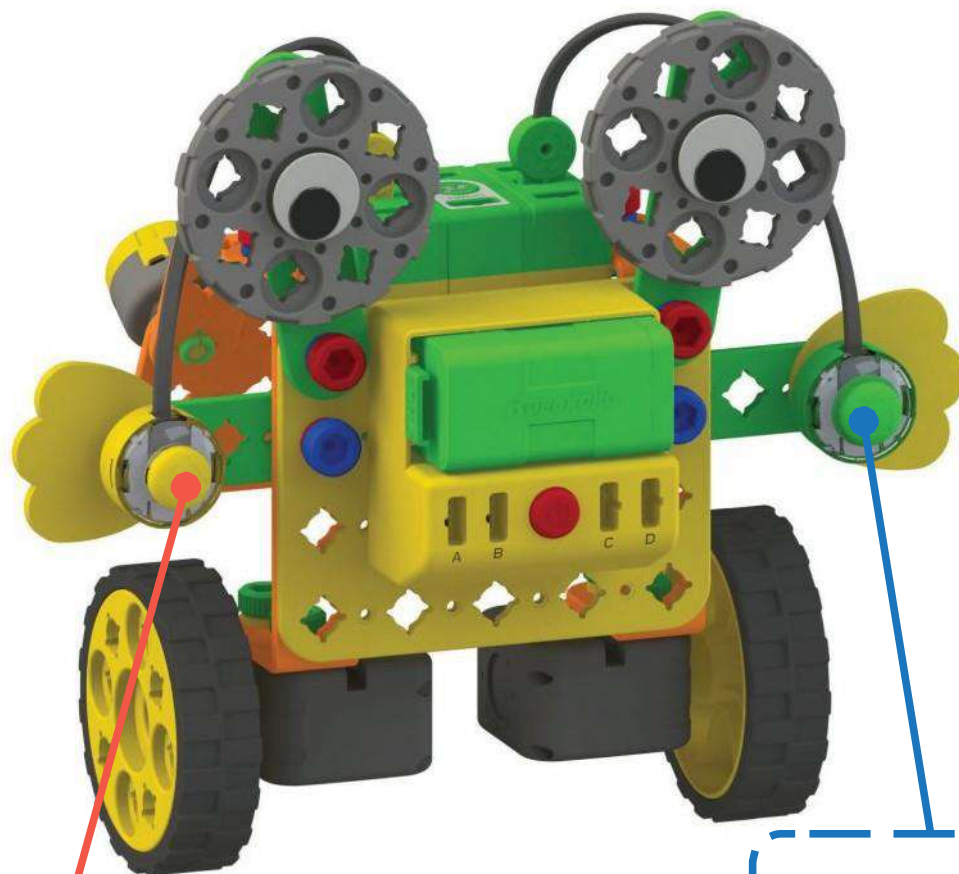

Контактный датчик (Y)  
Подключите к ЦП

Контактный датчик (G)  
Подключите к ЦП

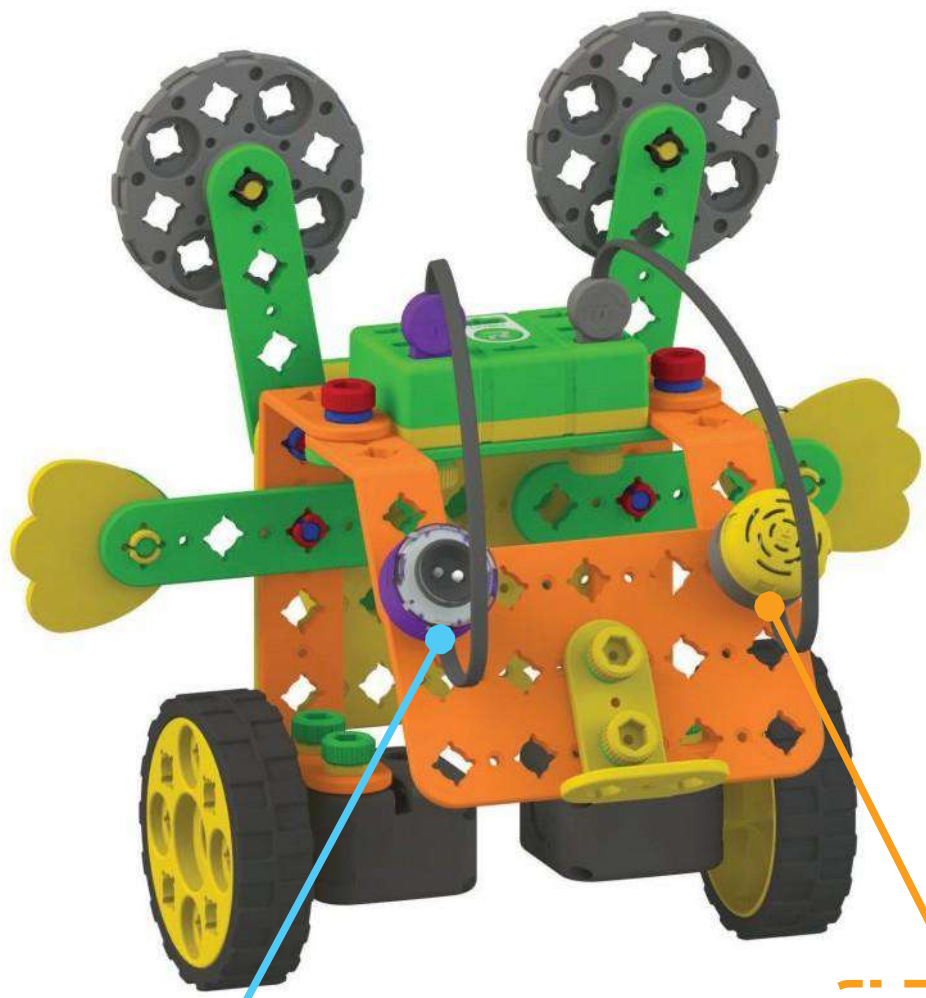
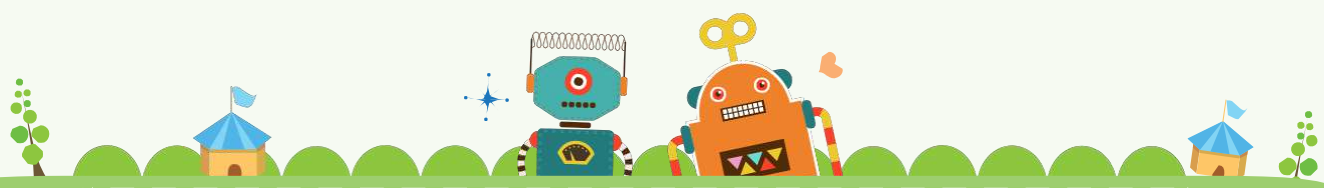

Инфракрасный датчик  
Подключите к ЦП

Плата мелодий  
Подключите к ЦП





Запрограммируем движение робота куклы на программной плате.



Управляйте музыкальной куклой с помощью инфракрасного датчика и контактных датчиков



Сыграем с роботом-уборщиком!

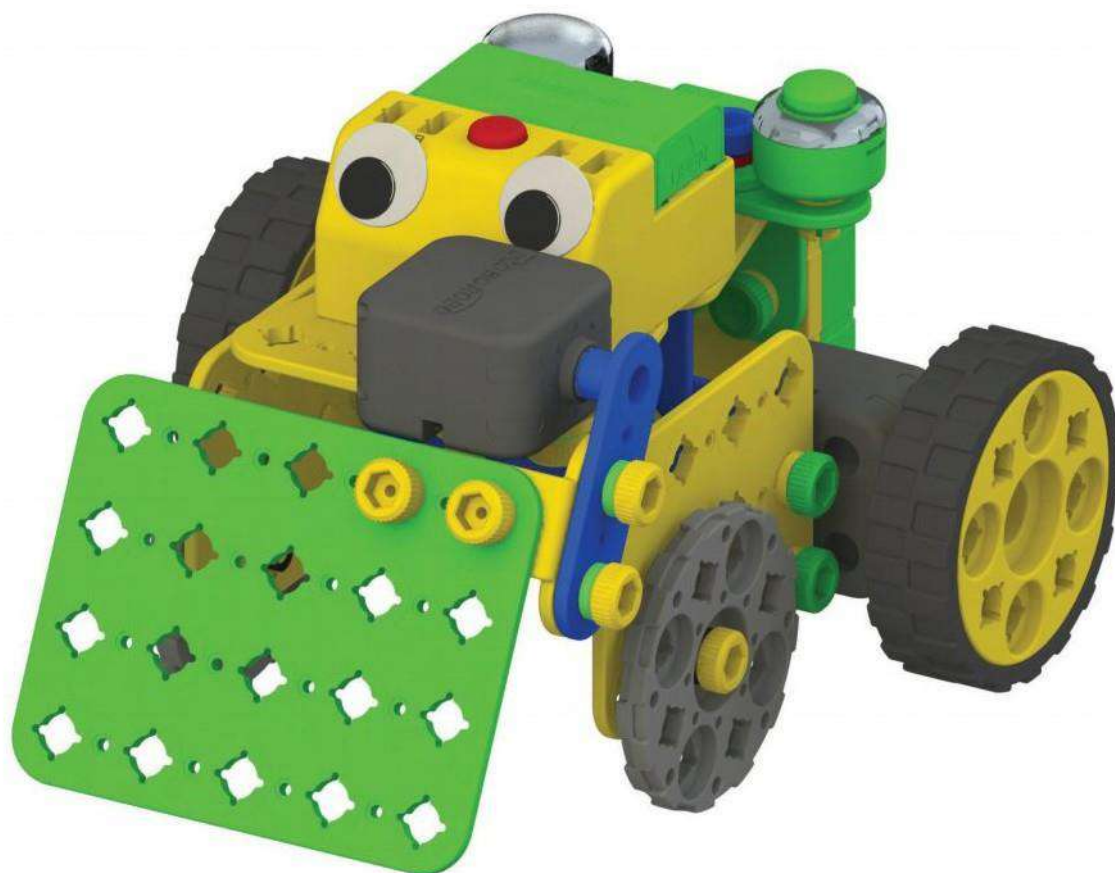

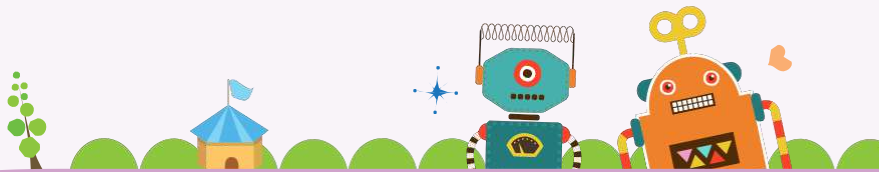

Детали



x2



x2



x4



x4

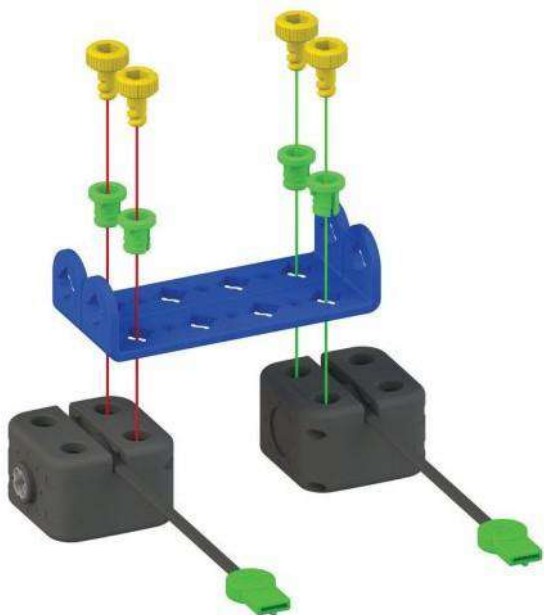

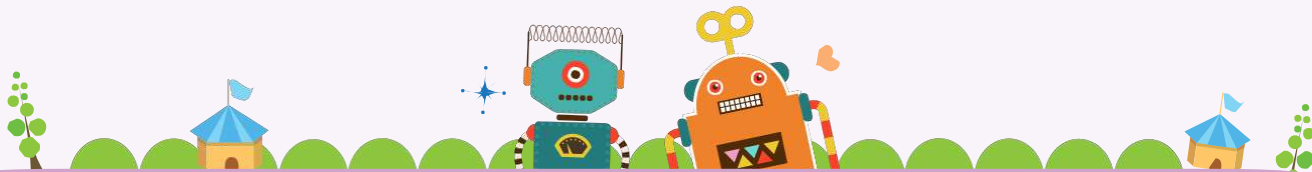

2

Детали



x2



x2



x2

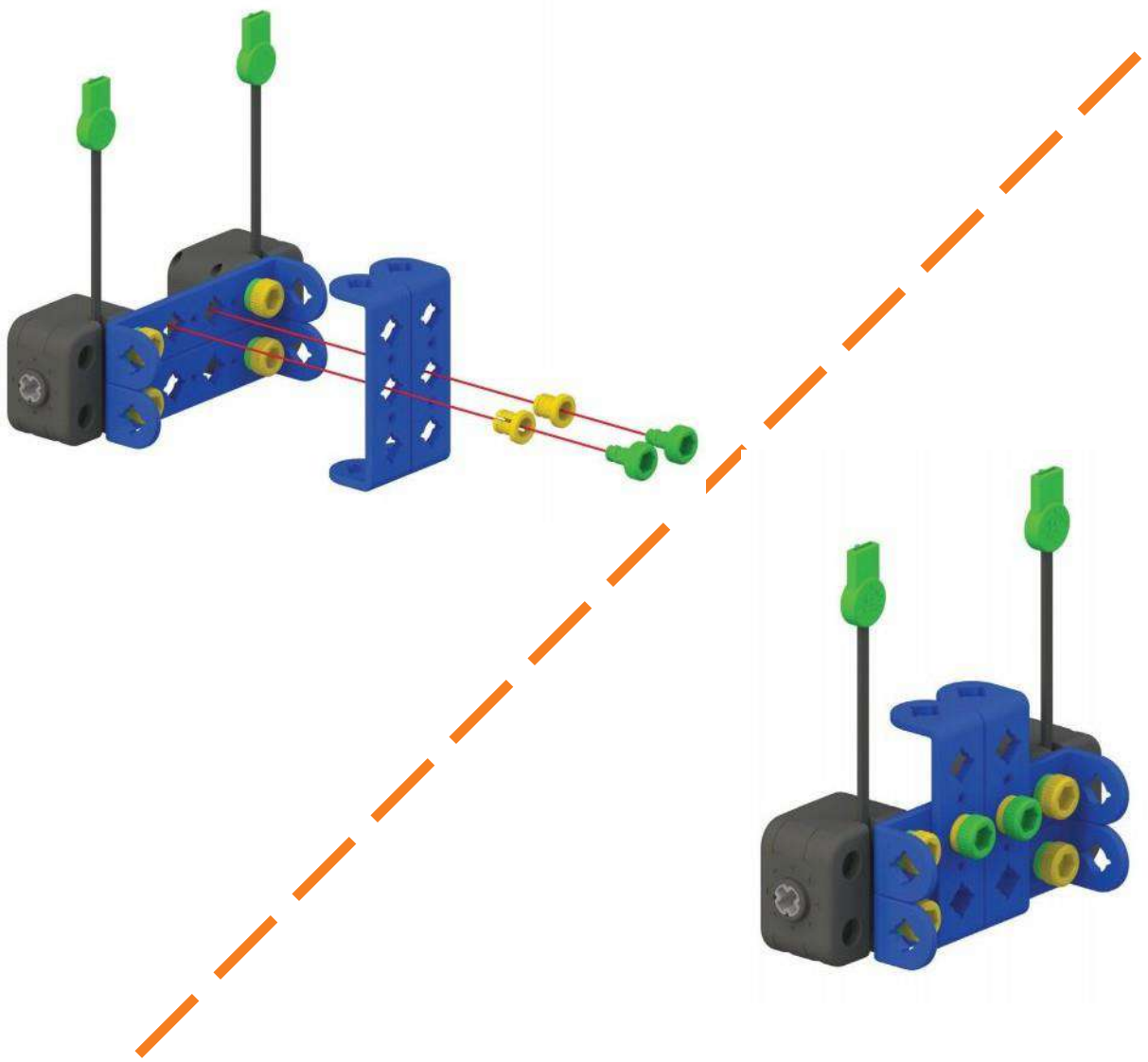

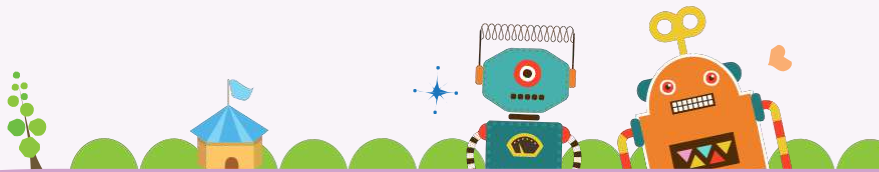

3

Детали



x2



x4



x4

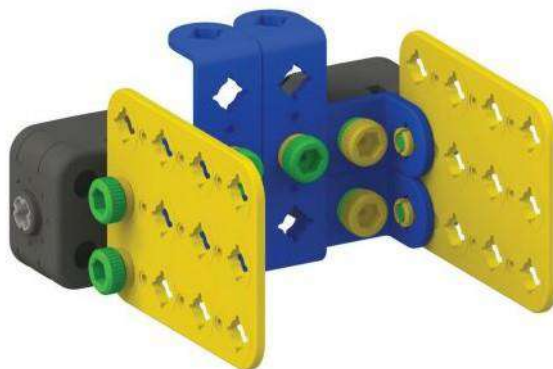
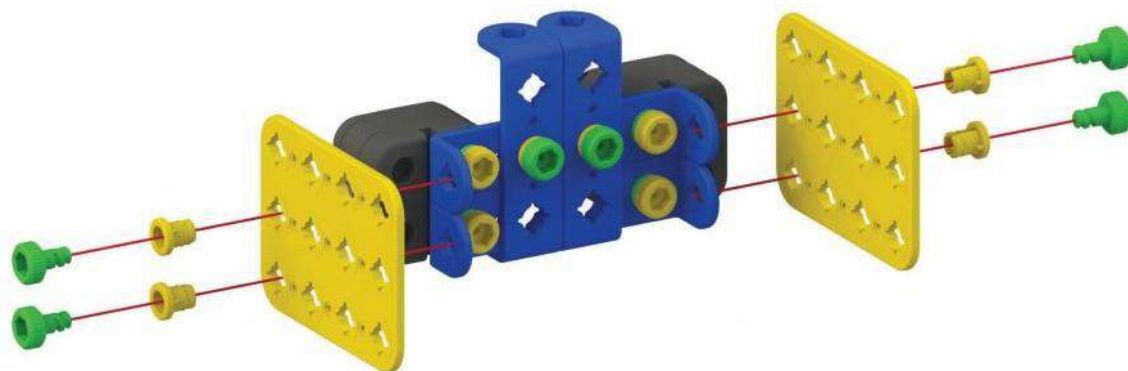

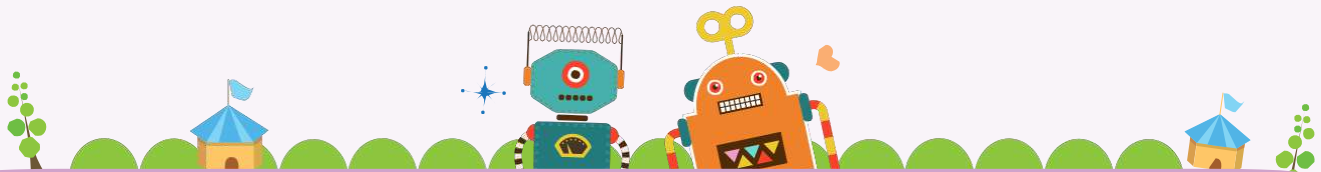

4

Детали



x1



x1



x1



x2



x1



x1



x2

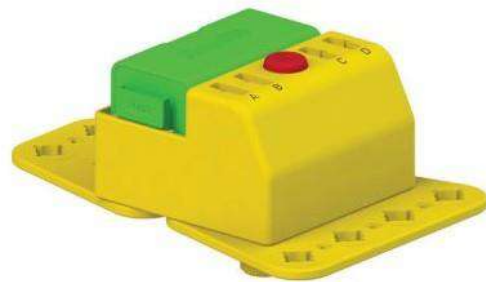
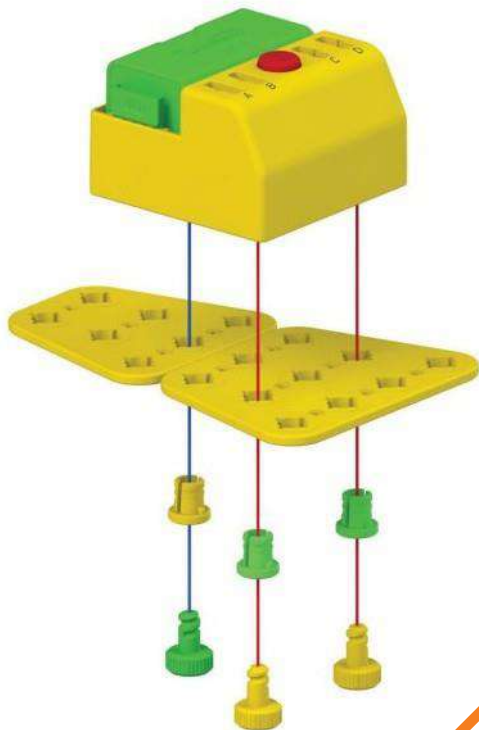

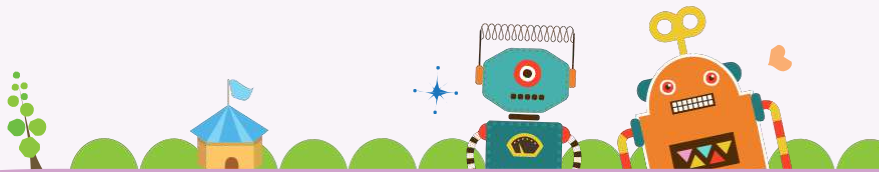

5

Детали



x1



x2



x2

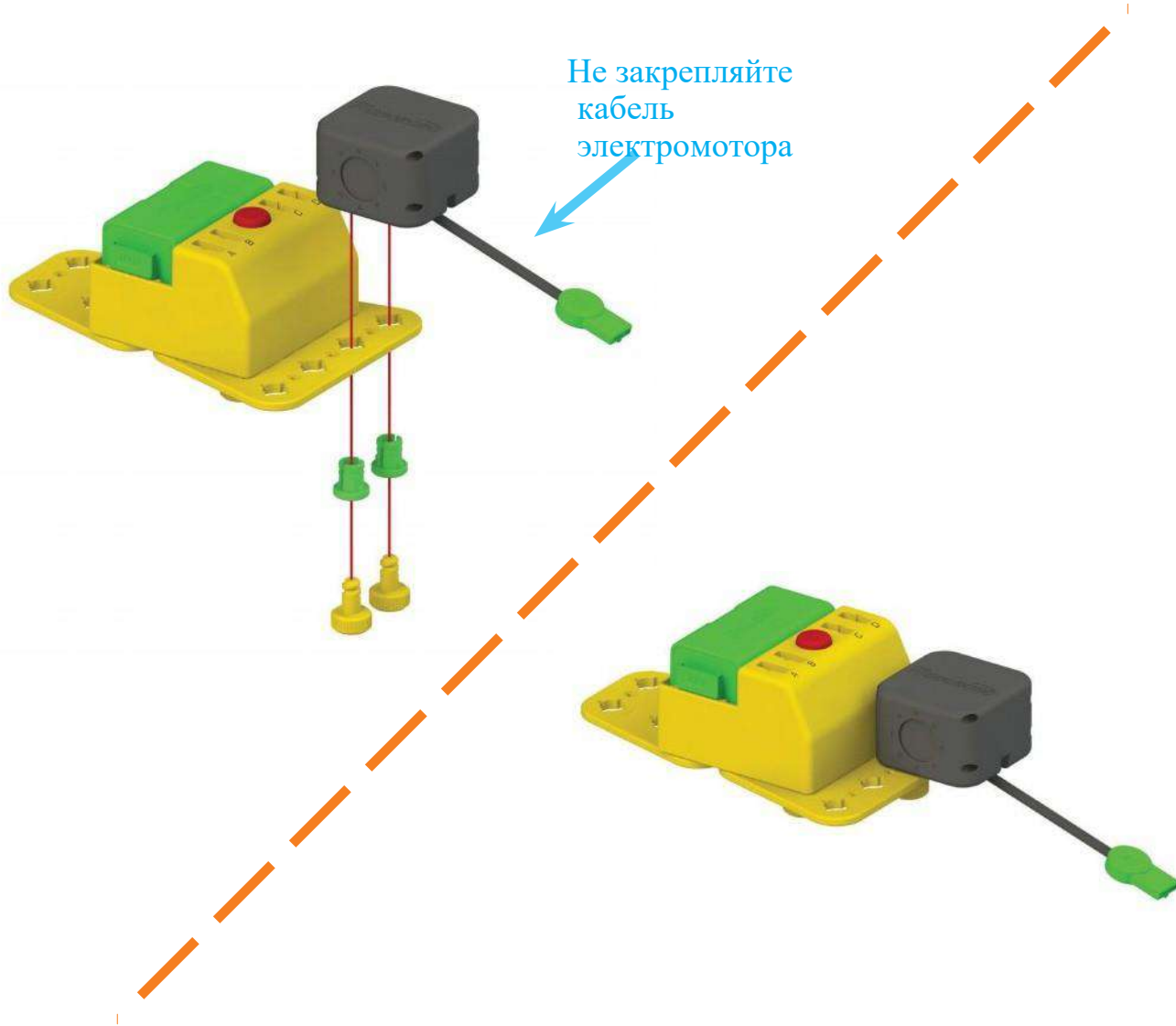

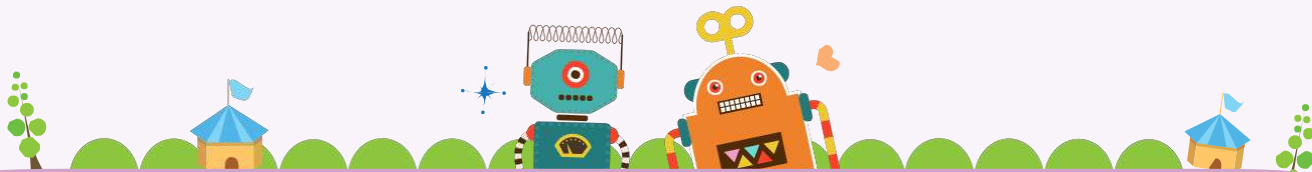

6

Детали



x2



x2





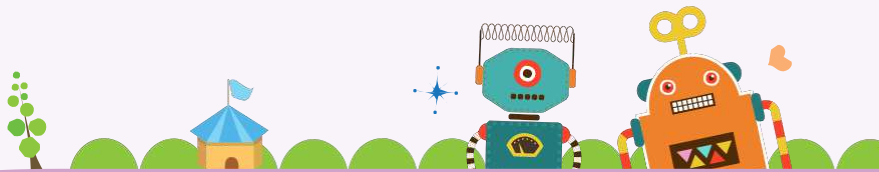

Детали



x1



x2



x2



x2

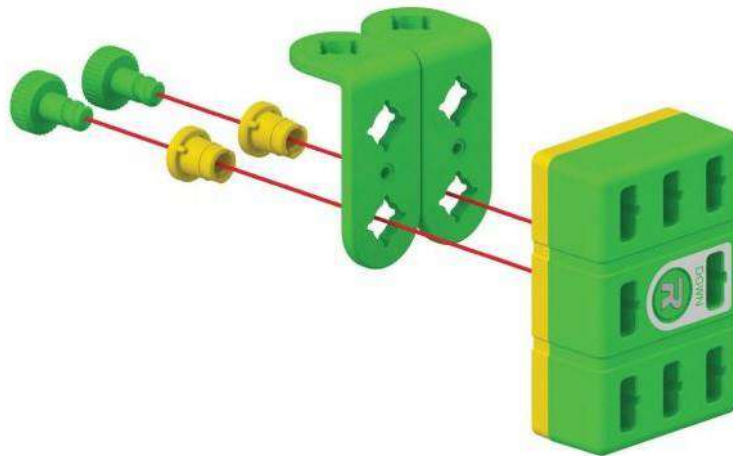

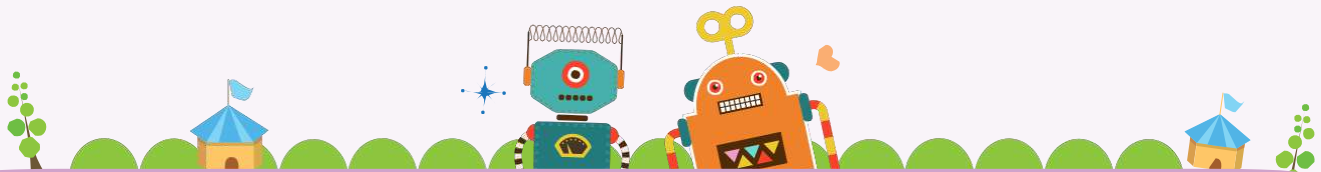

8

Детали



x1



x2



x2

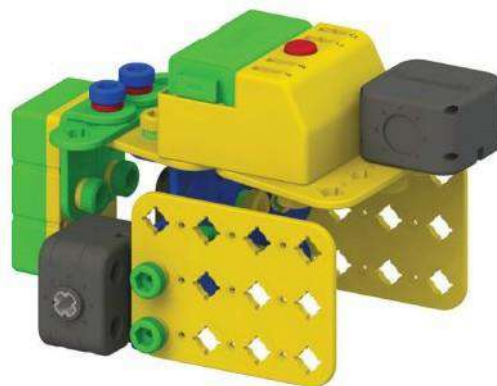
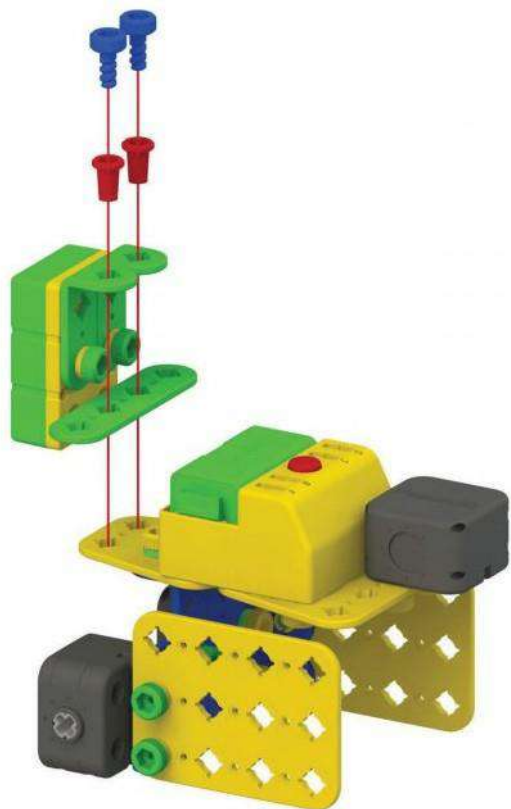

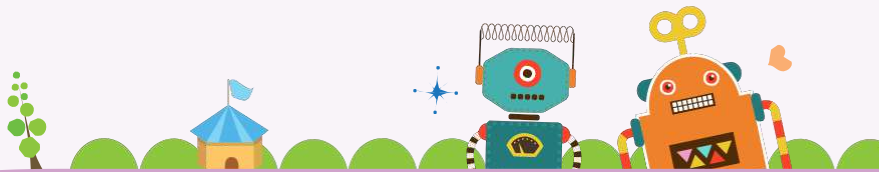

9

Детали



x2



x2



x2



x2

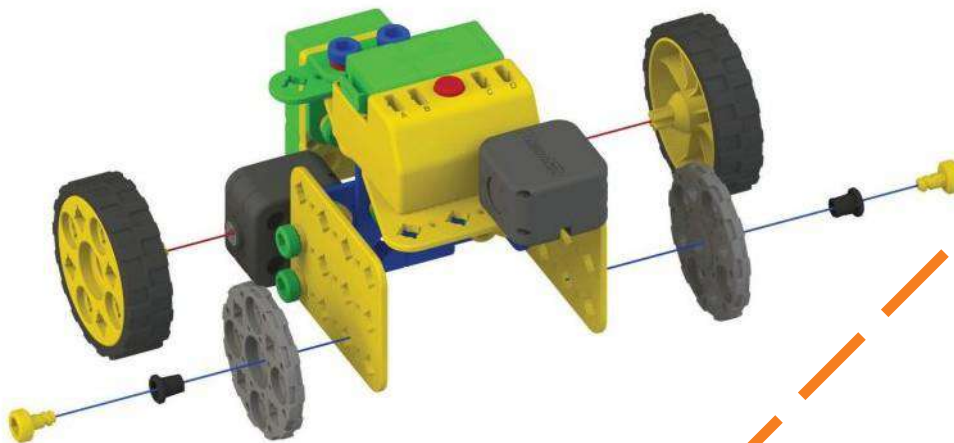

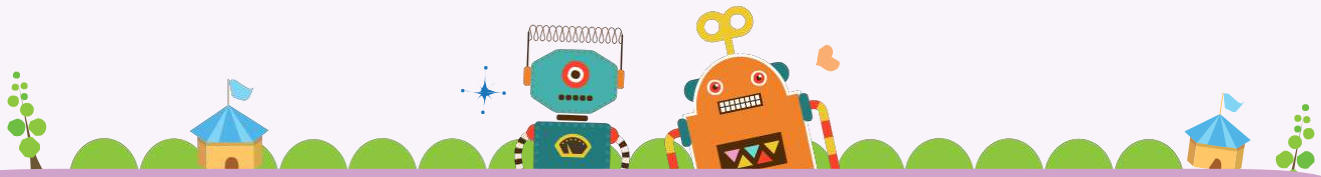

10

Детали

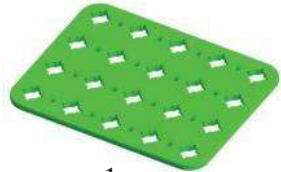

x1



x1



x1



x2



x2



x4

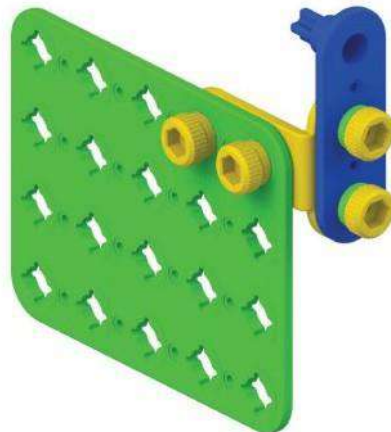
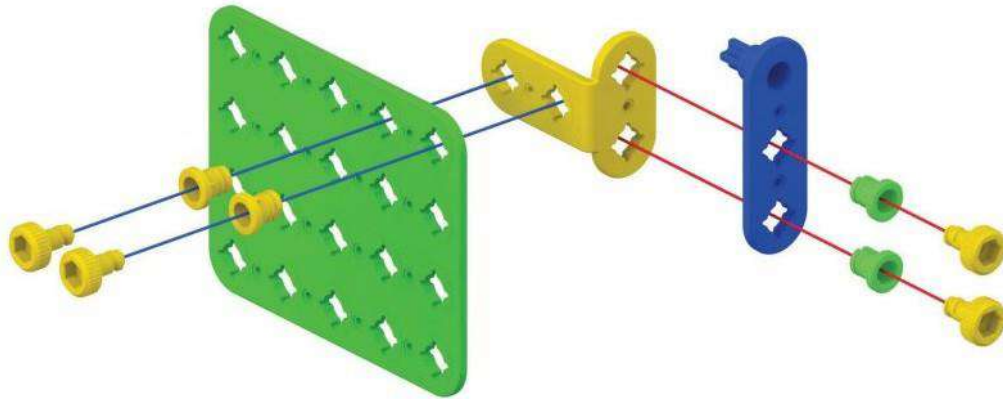

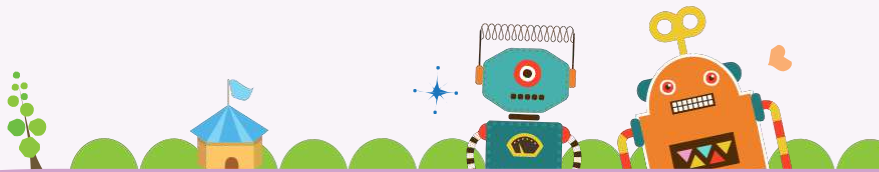

Детали

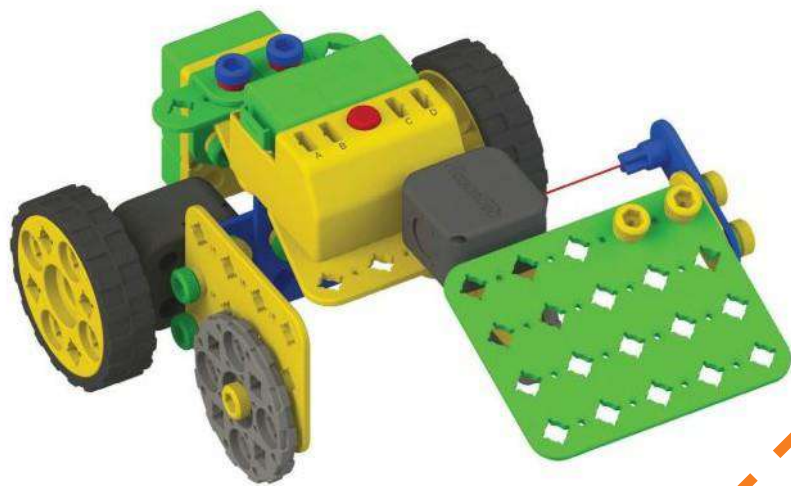
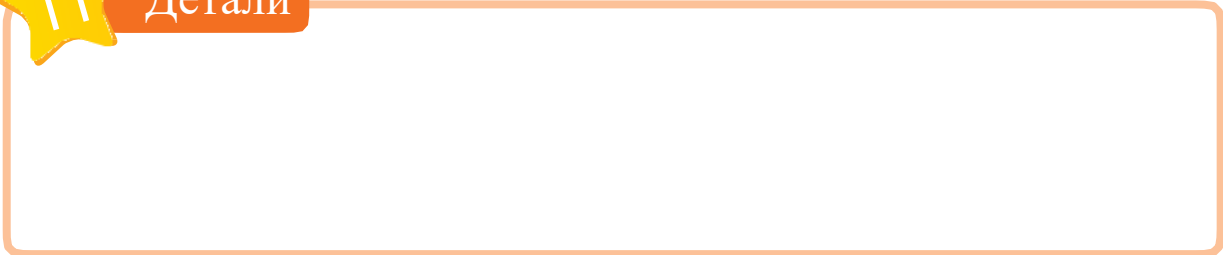

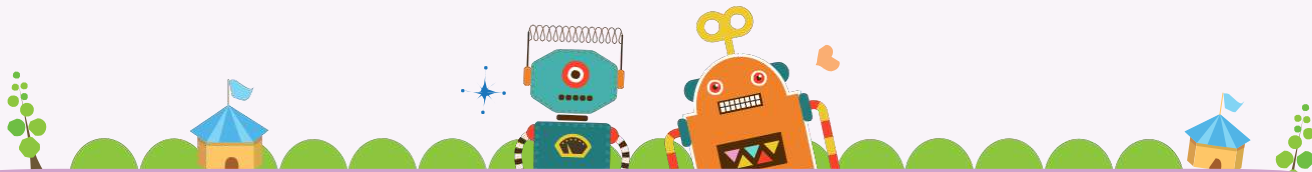

12

Детали



x1



x1



x2



x2

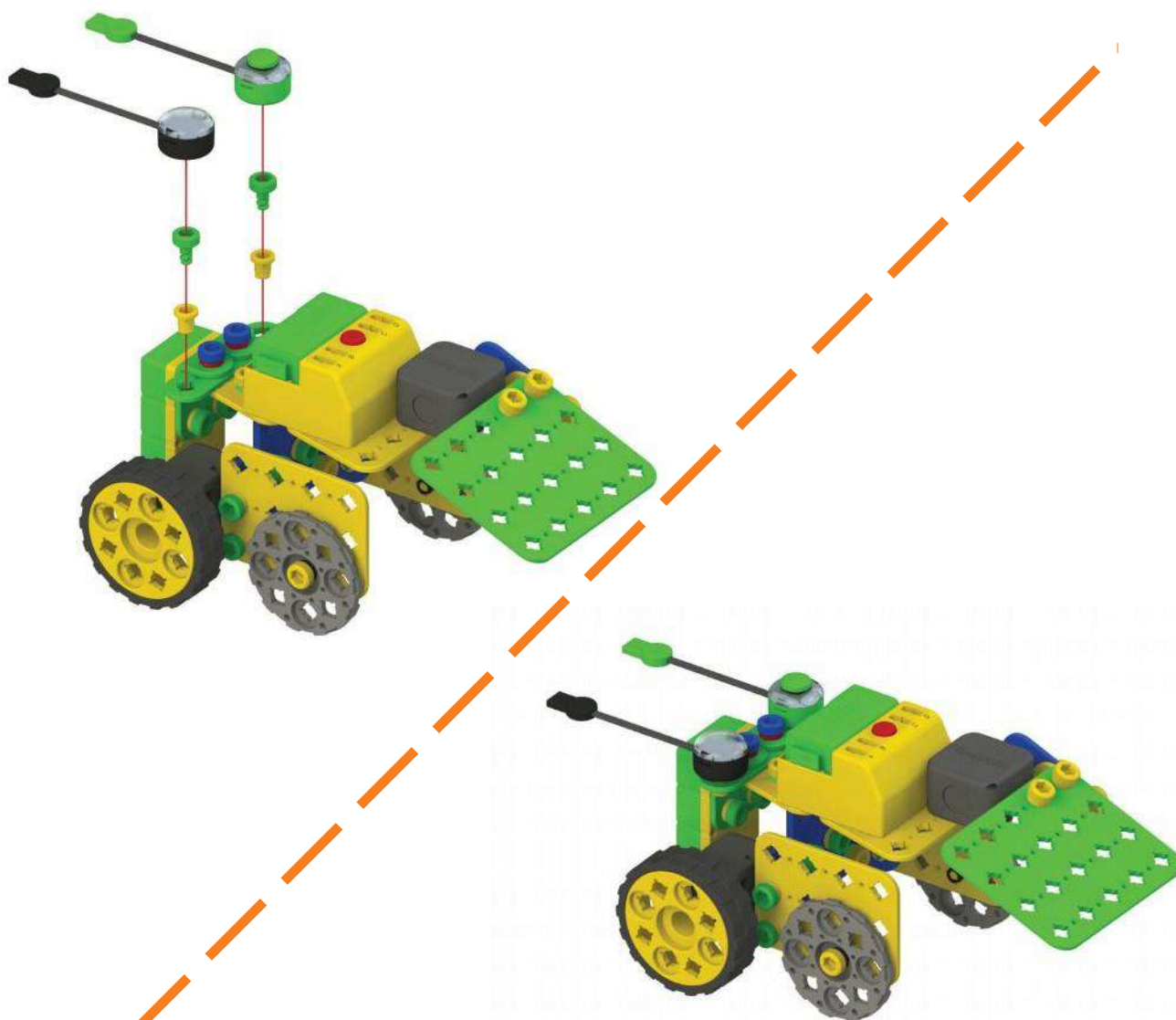

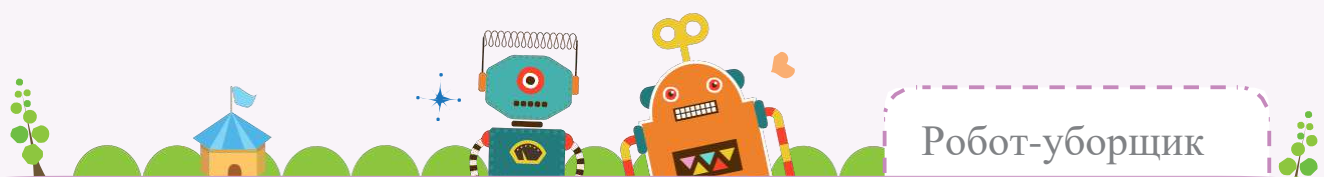

Робот-уборщик

Левый  
электромотор  
Подключите к А

Правый  
электромотор  
Подключите к В

Электромотор швабры  
Подключите к С

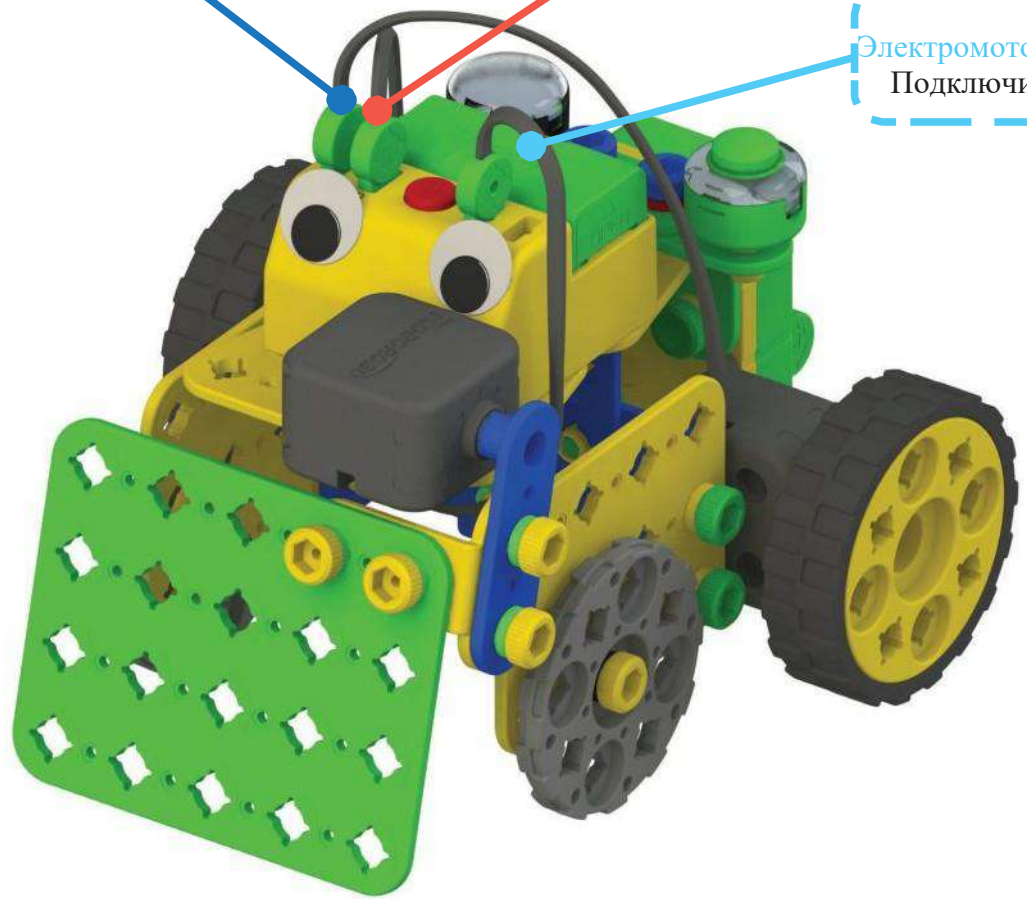

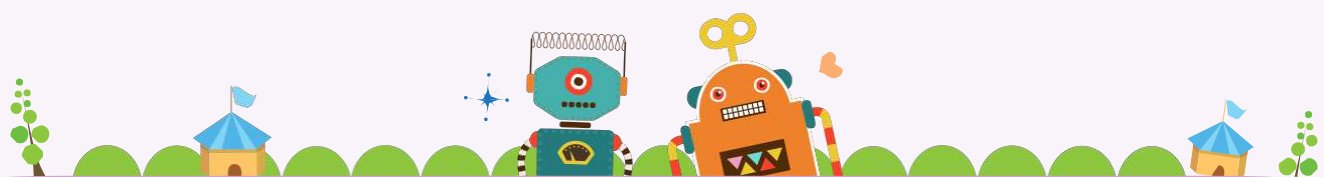

Двухсторонний кабель  
Подключите к порту D и ЦП

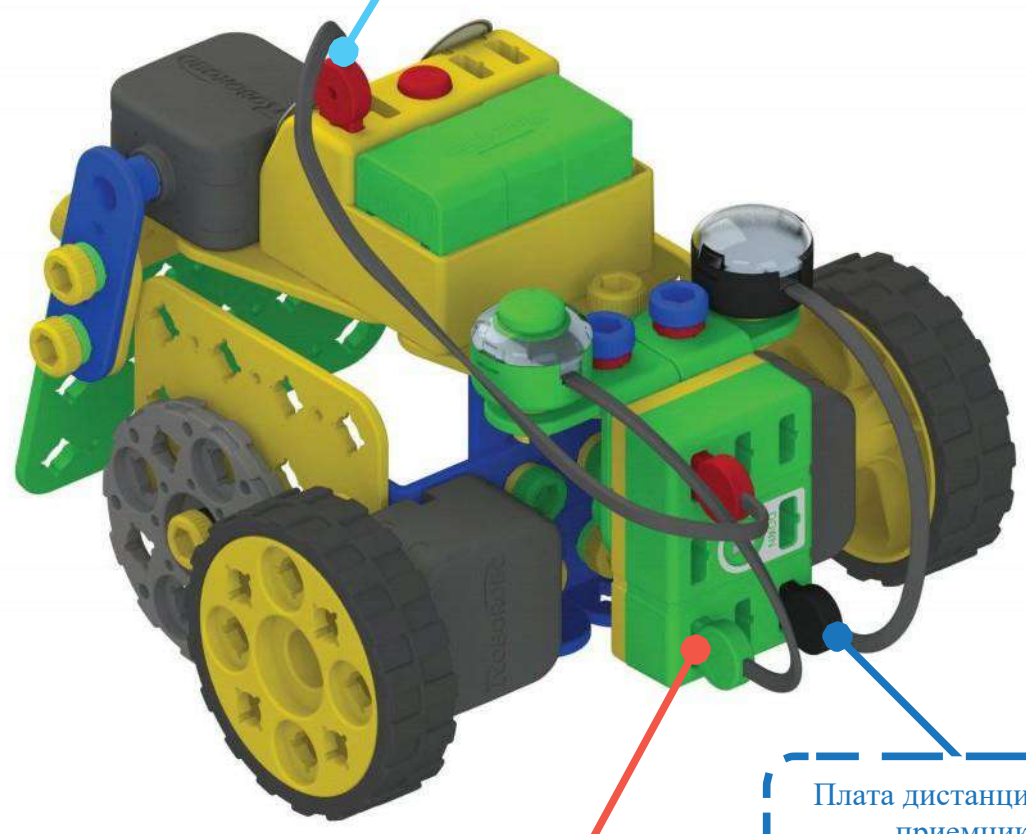

Контактный датчик (G)  
Подключите к ЦП

Плата дистанционного приемника  
Подключите к ЦП





Запрограммируем движение робота уборщика на программной плате.



Управляйте роботом-уборщиком с помощью устройства дистанционного управления

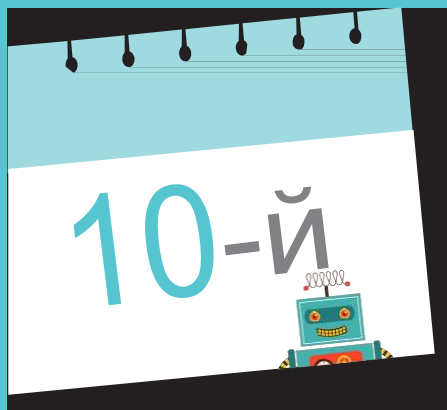

Сыграем с исследовательским роботом!



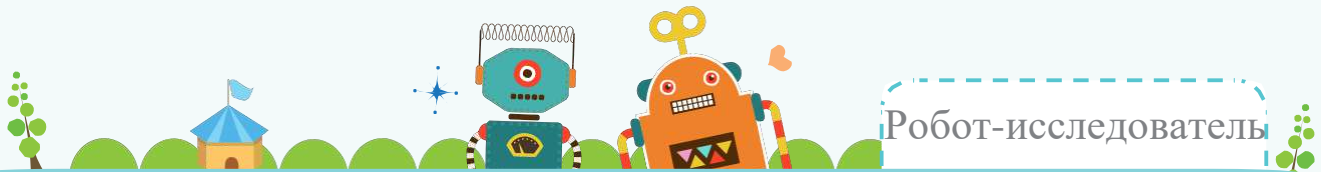

Детали



x1



x1



x1



x1



x2



x2



x1

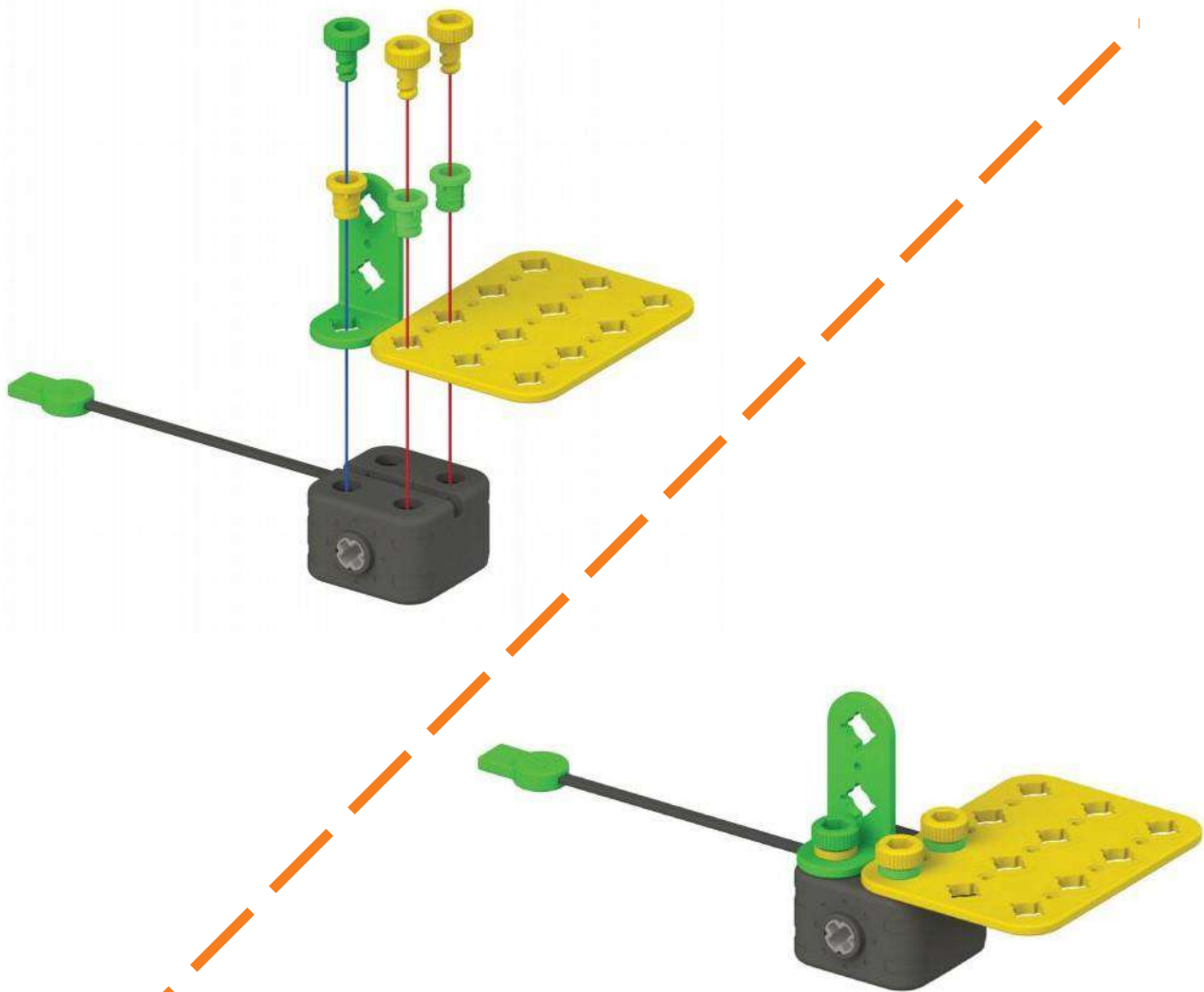

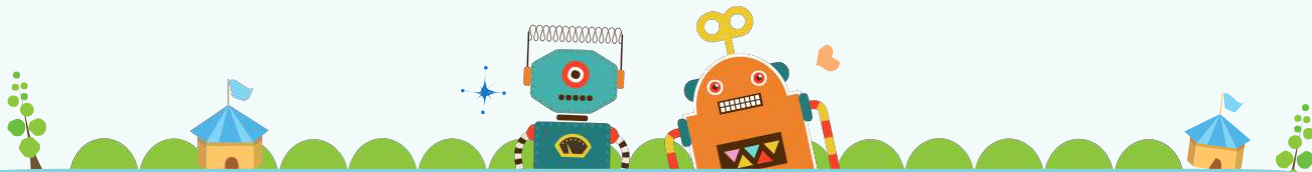

2

Детали



x1



x2



x2



x2

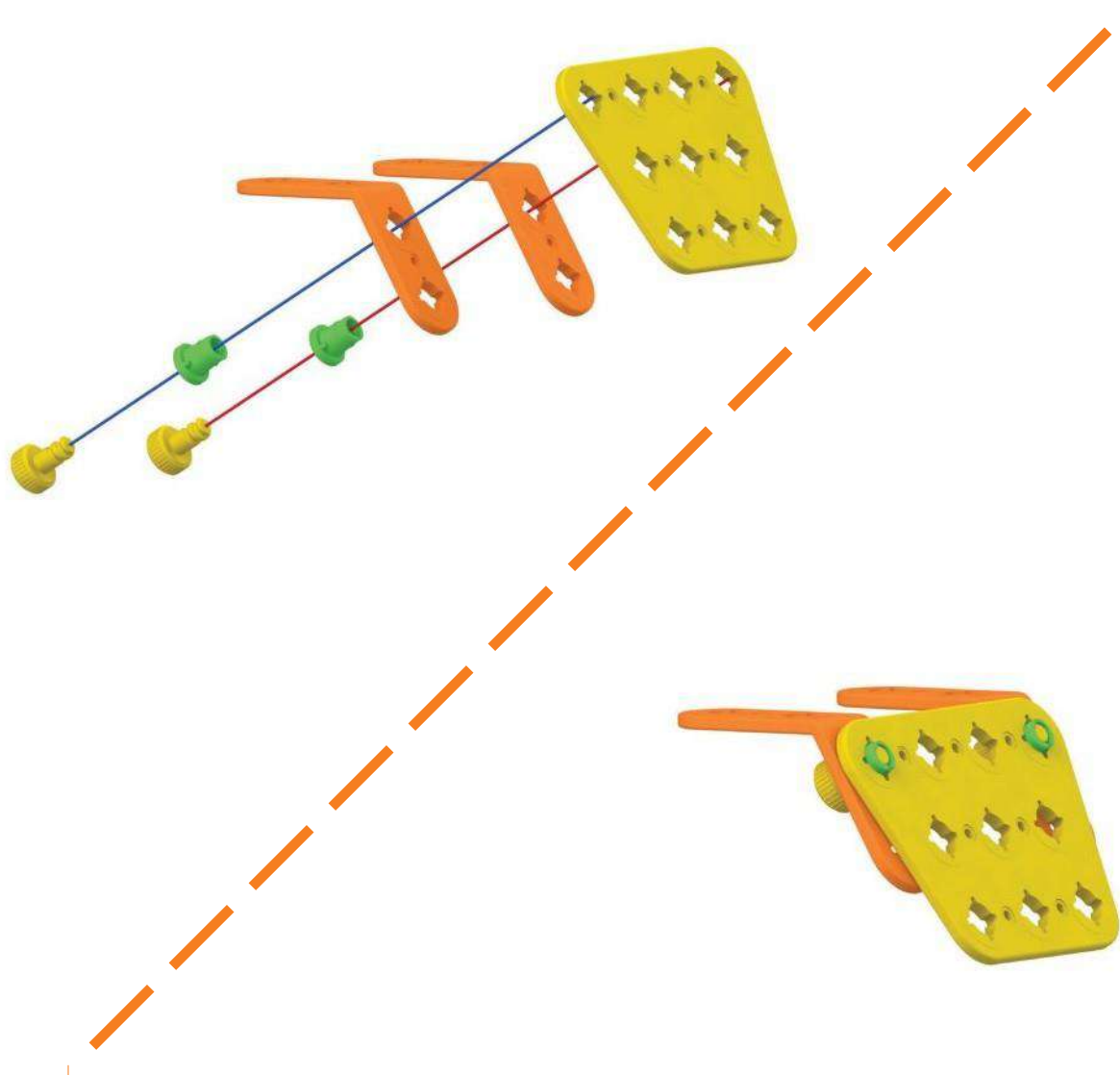

3

Детали



x1



x2



x2

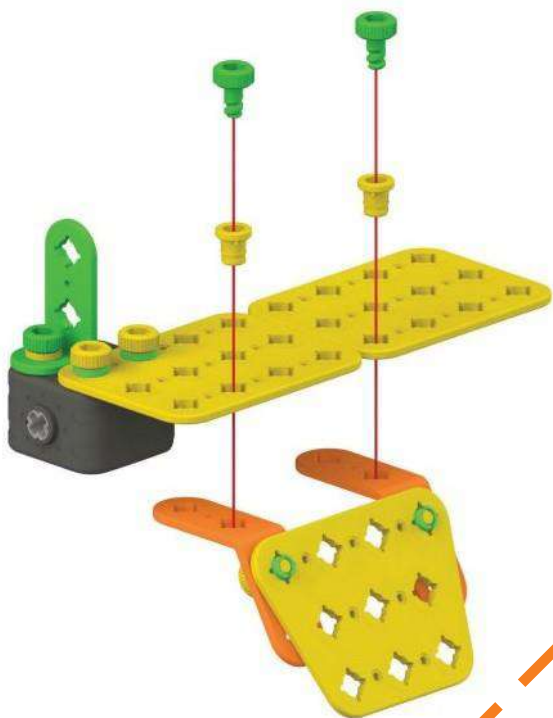

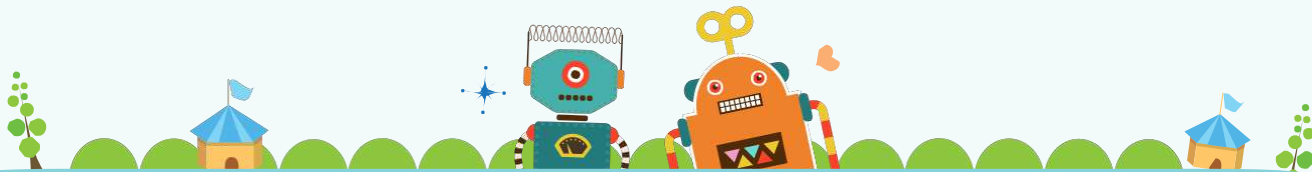

4

Детали



x1



x1



x2



x2



x2



x2

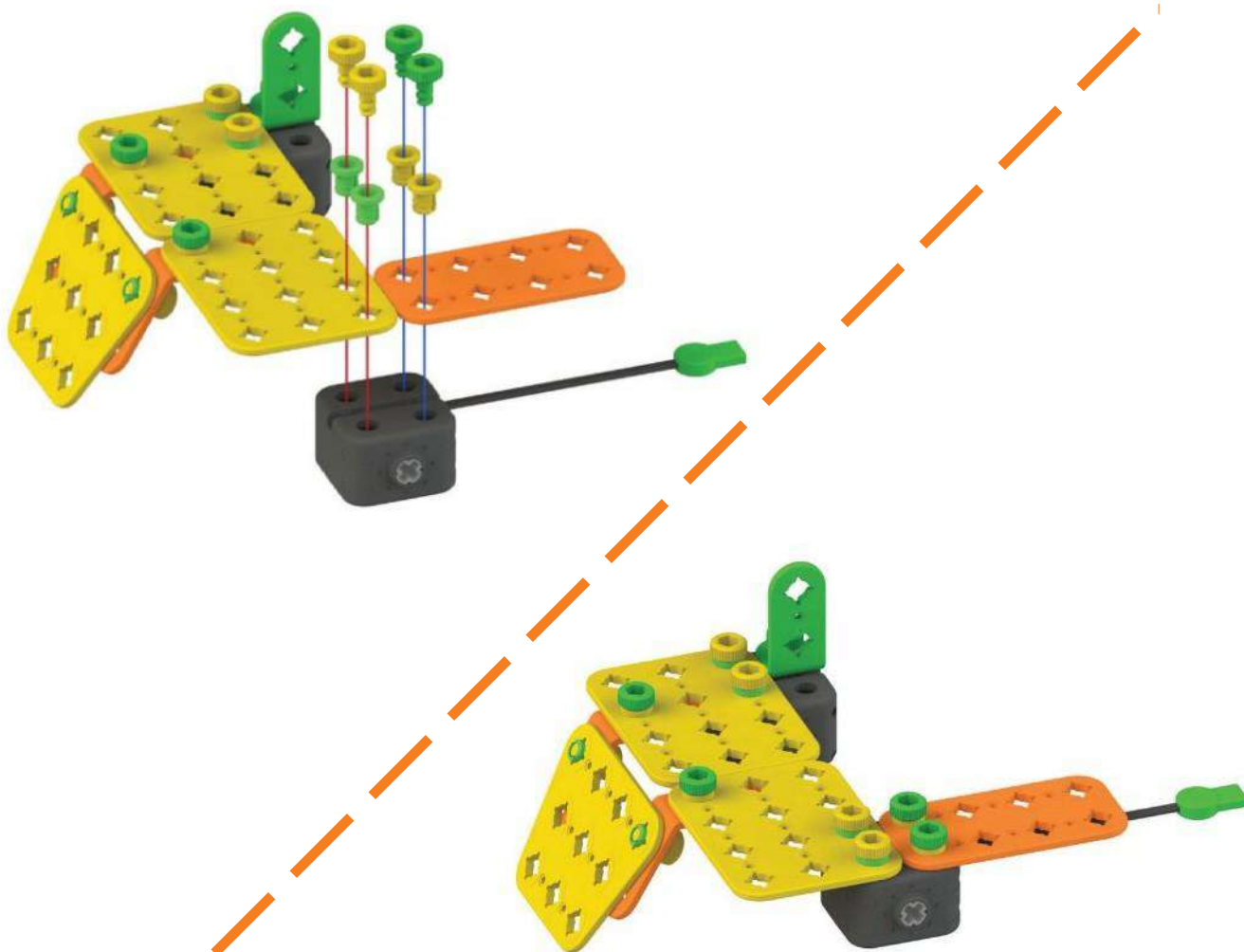

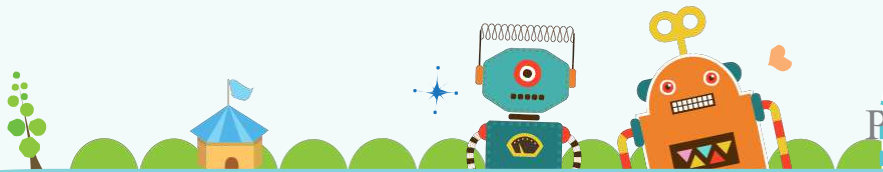

5

Детали



x1



x2



x2

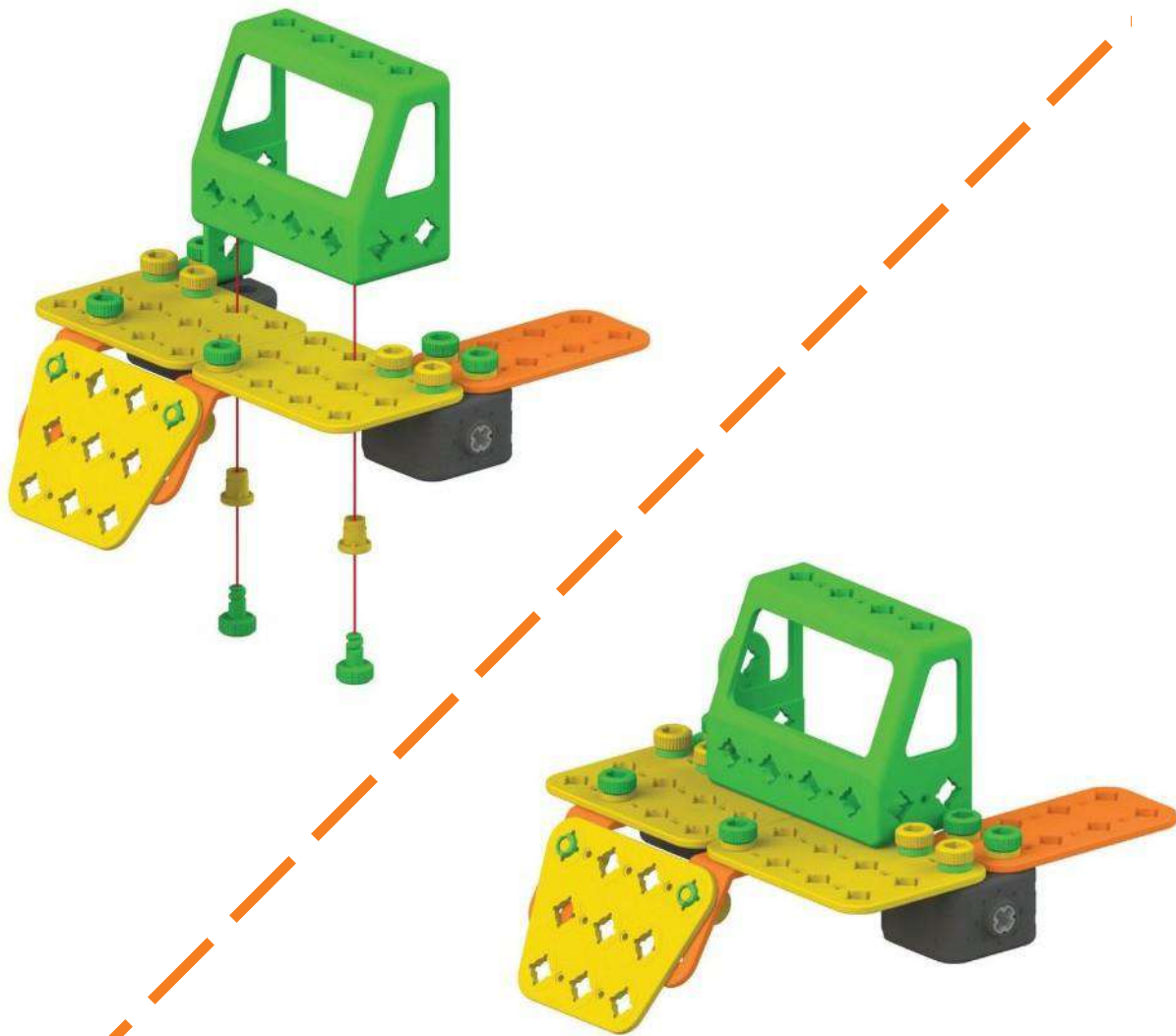

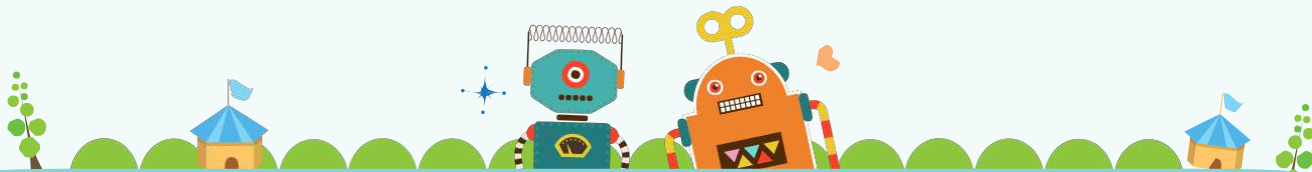

6

Детали



x1



x2



x2

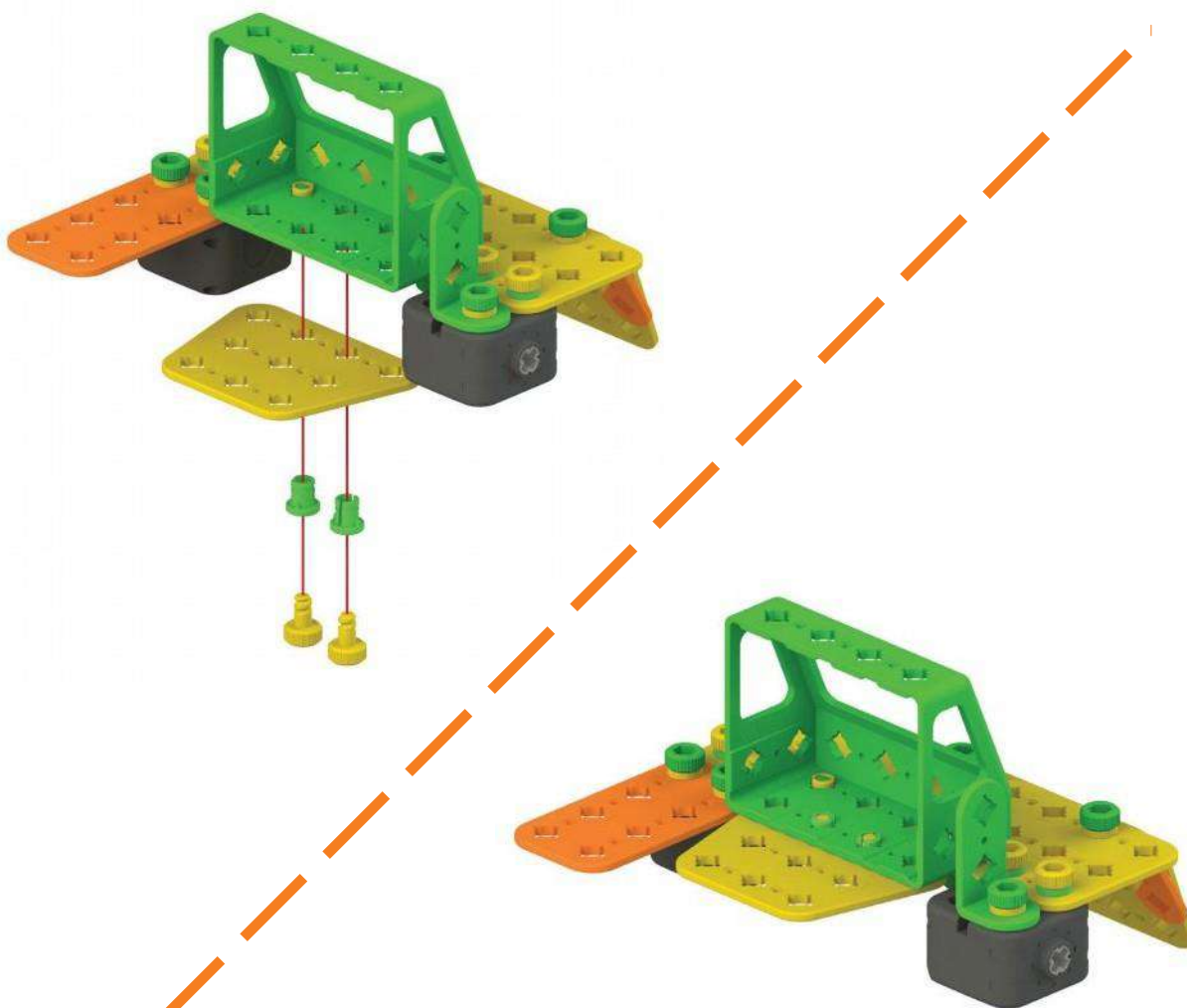





Детали



x1



x1



x2



x2



x2



x2

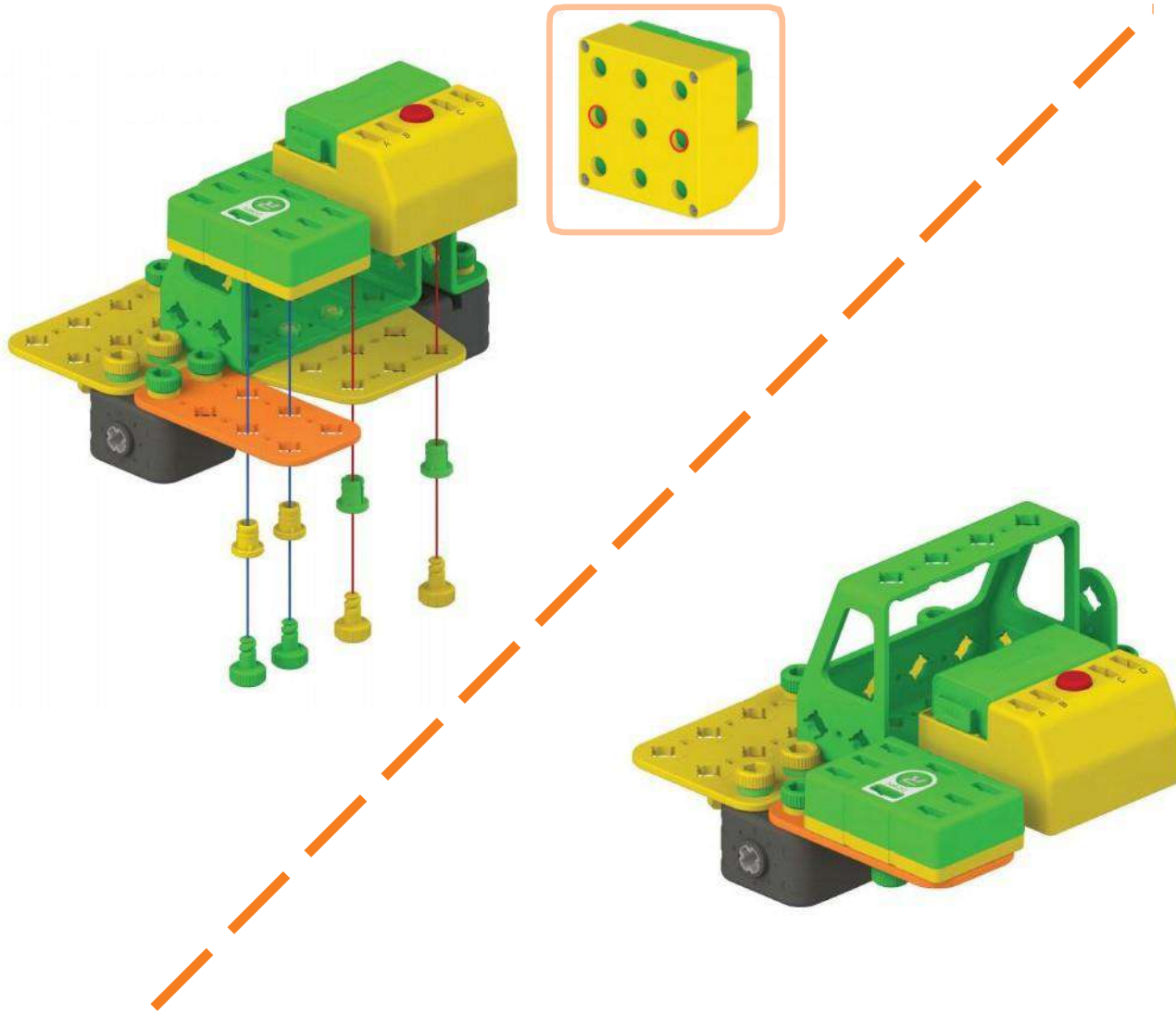

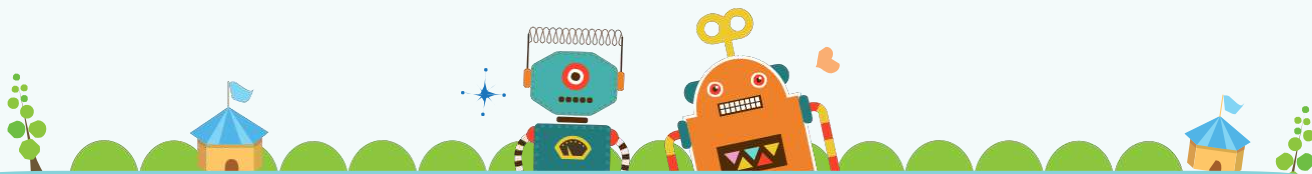

8

Детали



x1



x2



x2

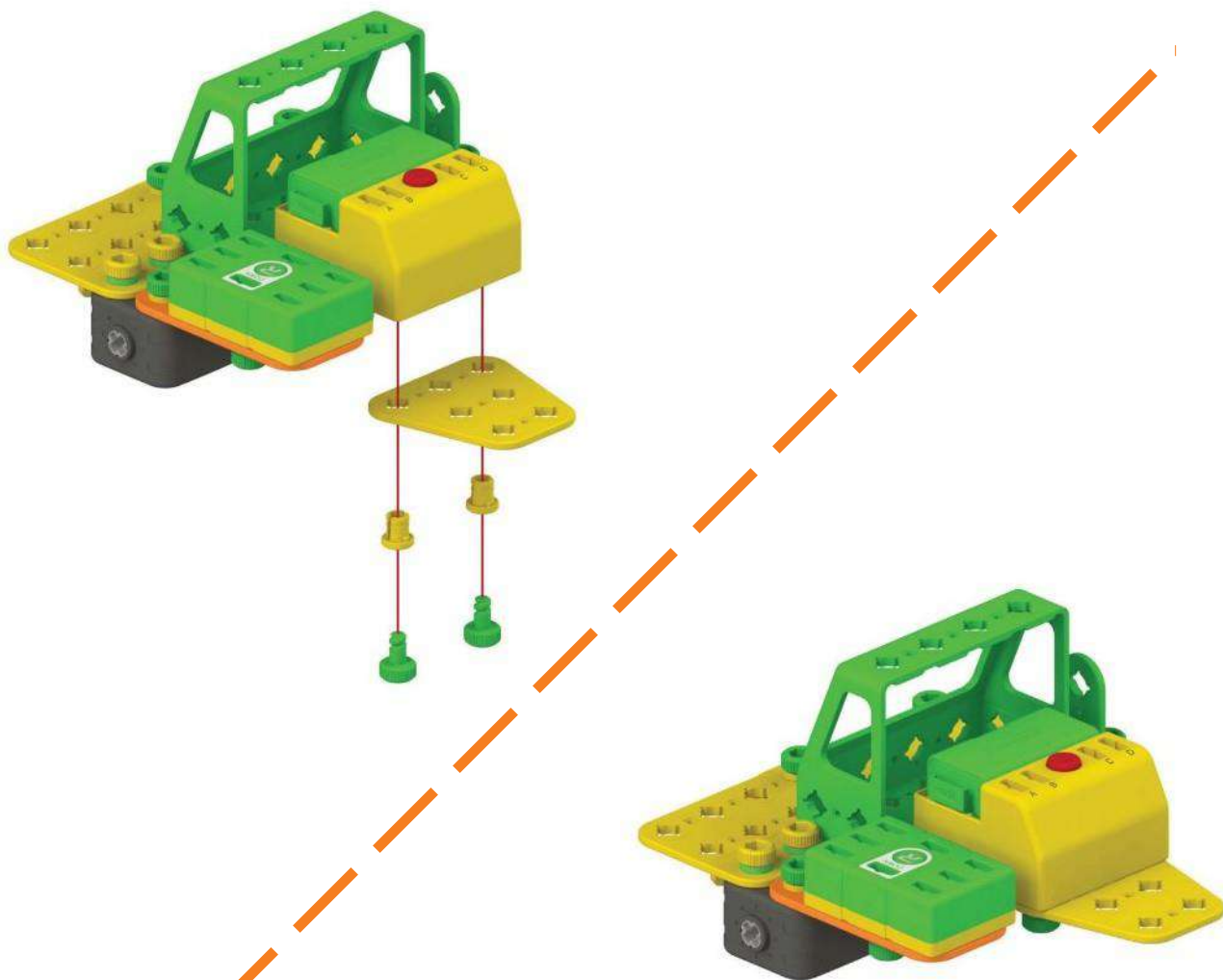

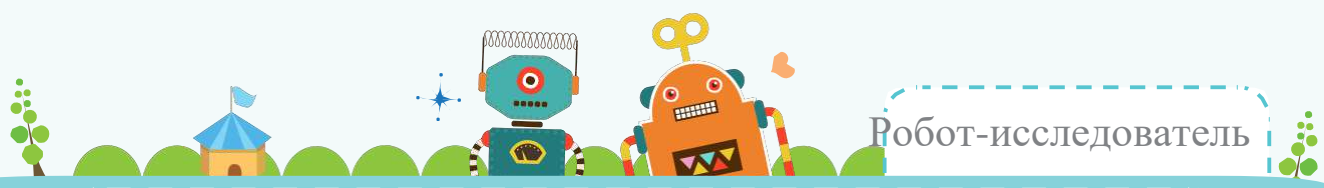

9

Детали



x1



x2



x2

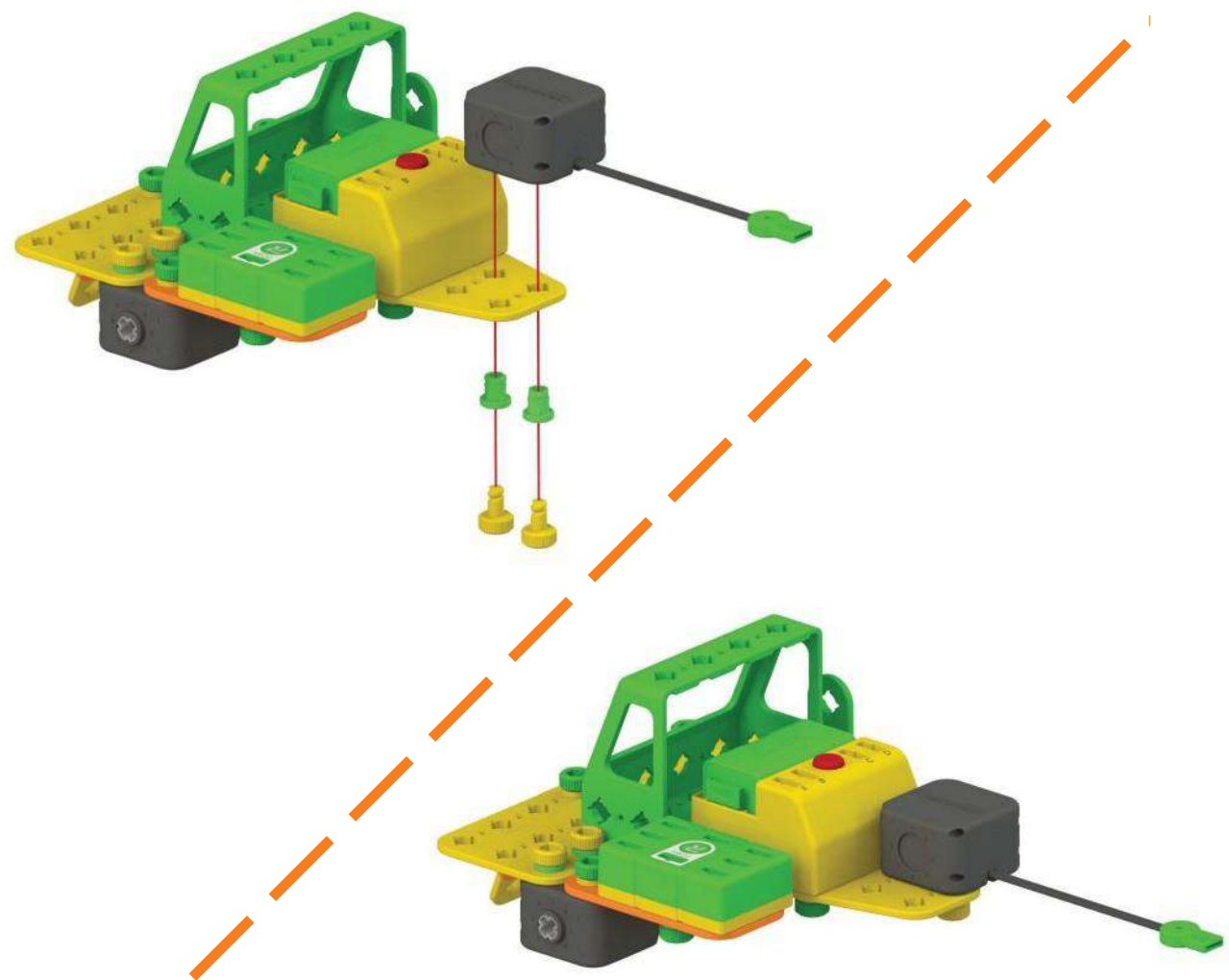

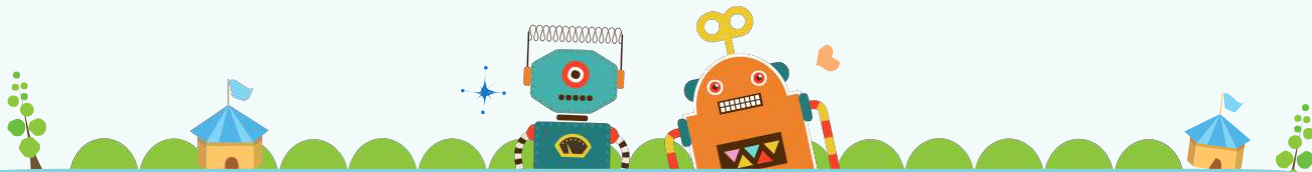

10

Детали



x1



x2



x2





Детали



x1

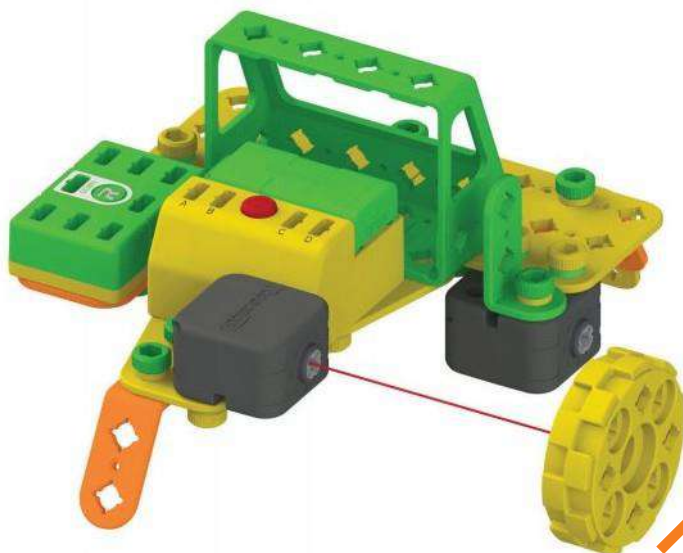

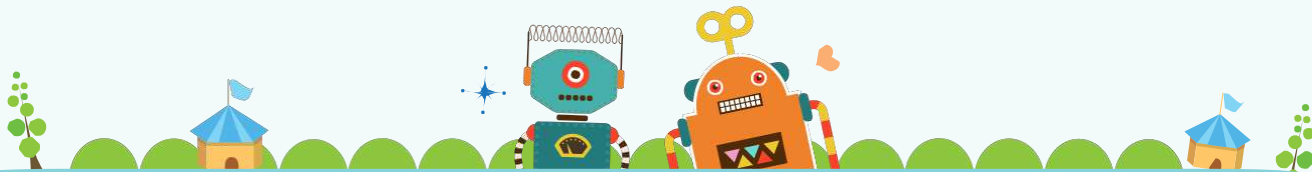

12

Детали



x1



x1



x2



x2

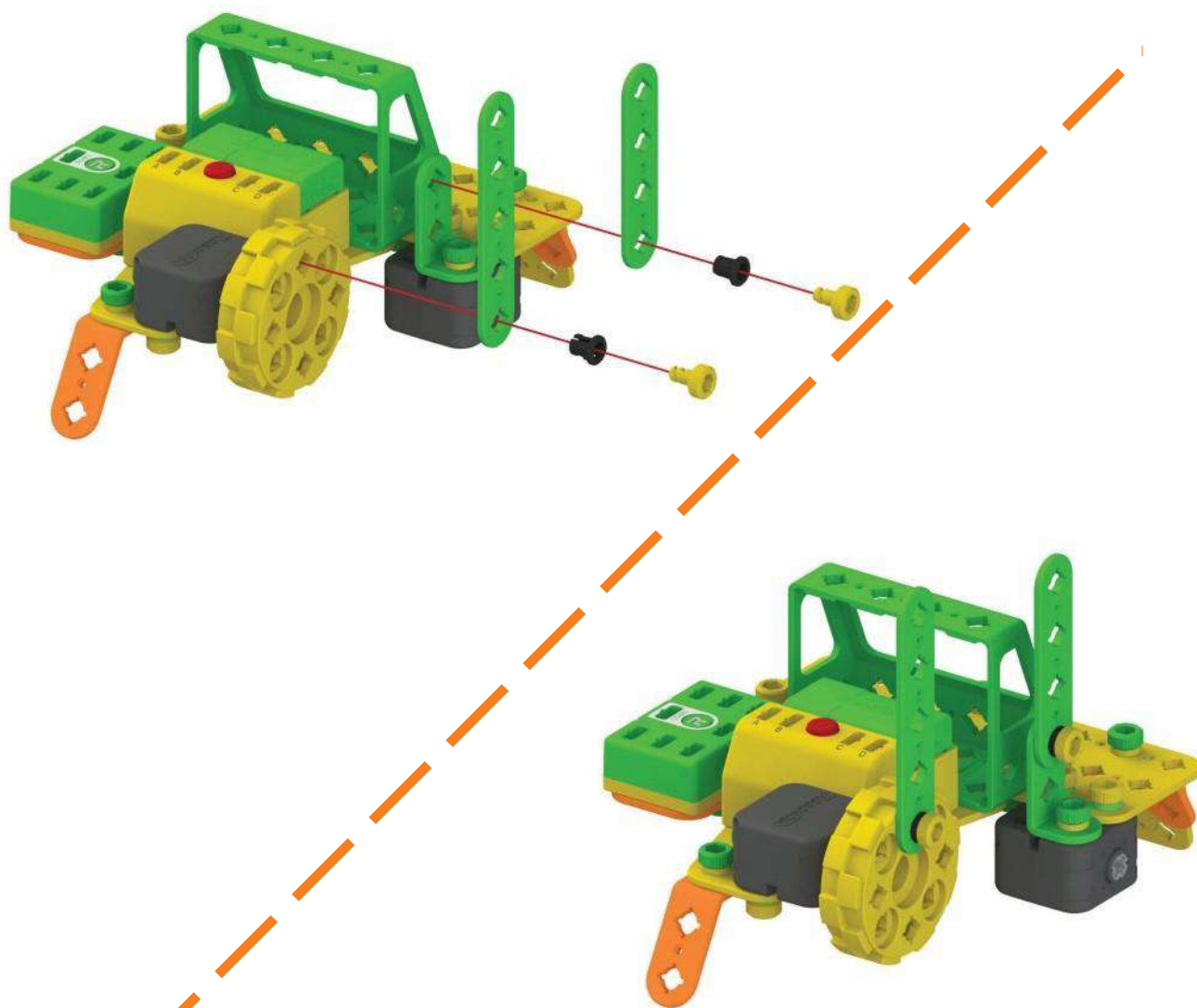

13 Детали



x1



x1



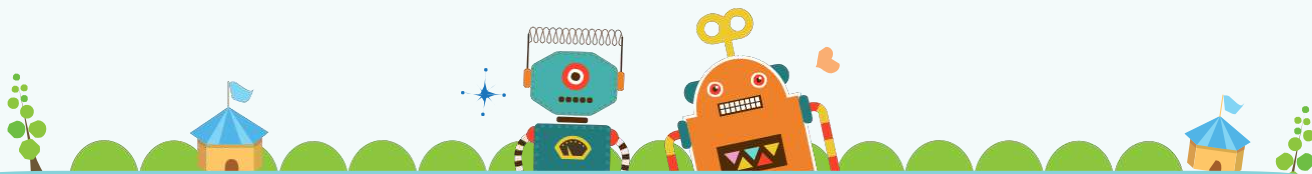

14

Детали



x1



x1



x1





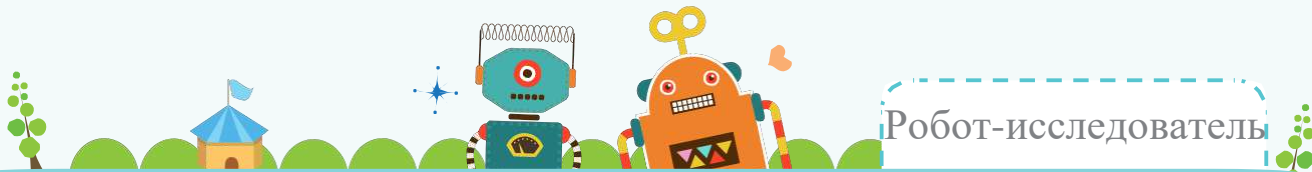

15

Детали



x1



x1



x3



x6



x6

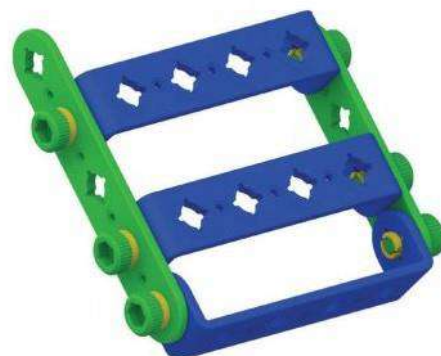
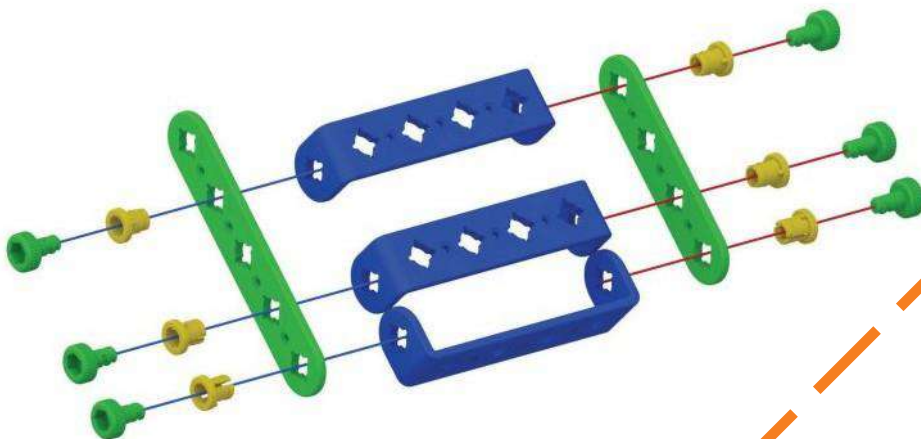

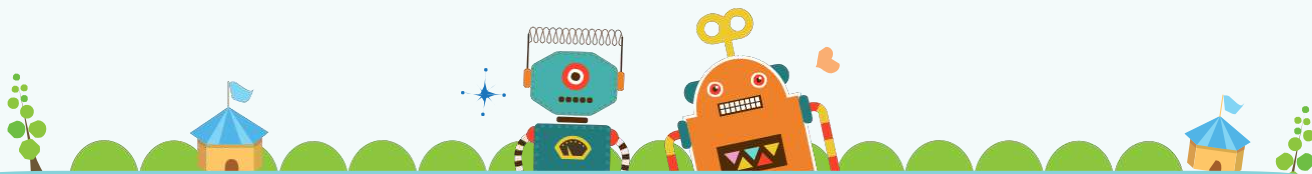

16

Детали



x2



x1



x1

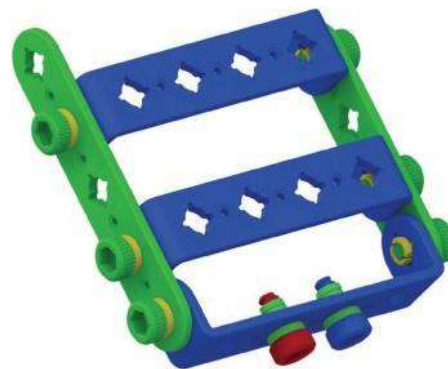
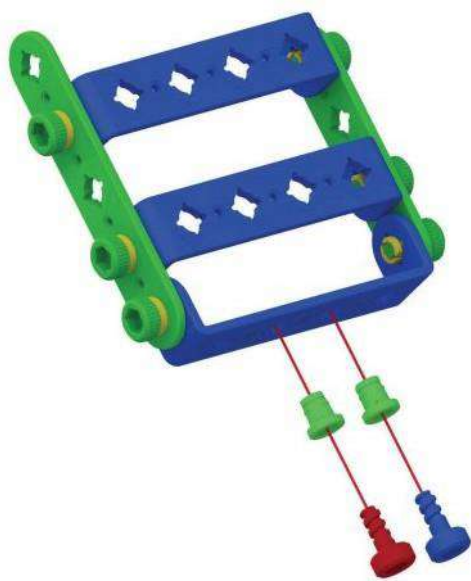

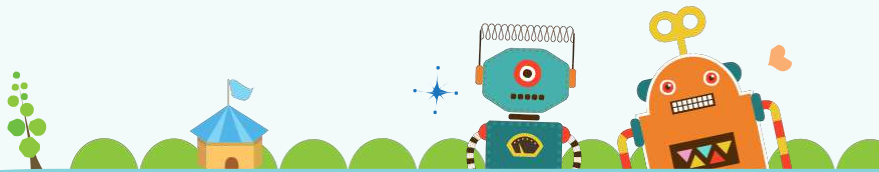

Детали



x1



x1



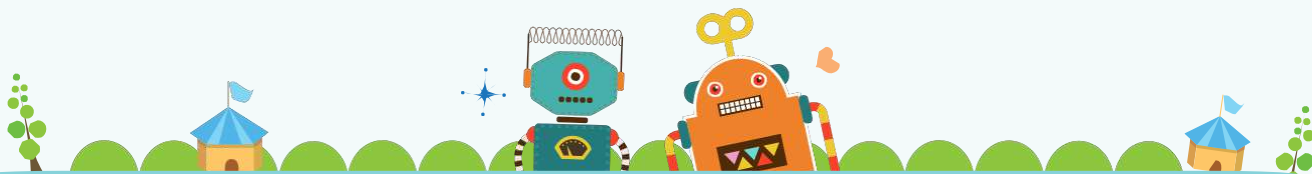

18

Детали



x2

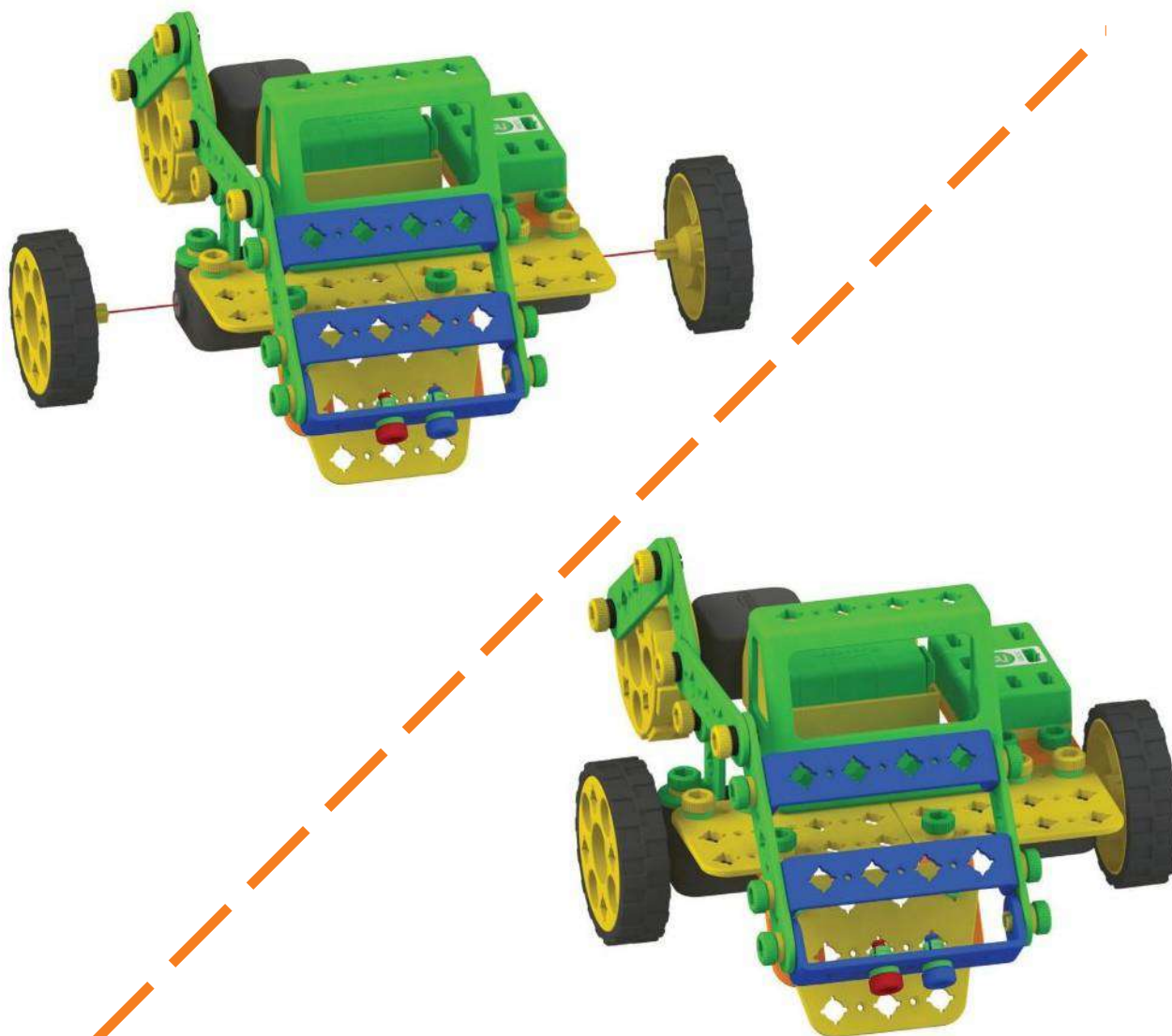

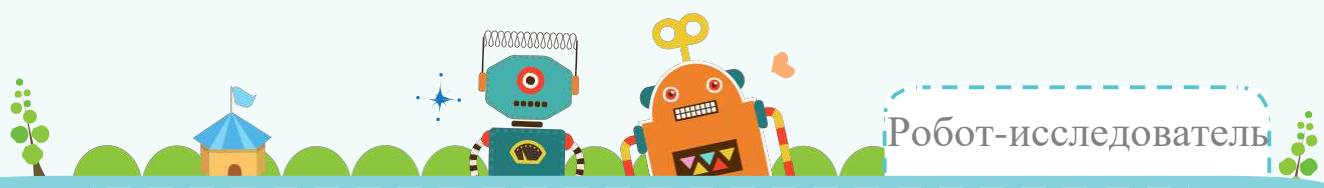

19

Детали



x1



x1



x1



x1



x4



x3



x1

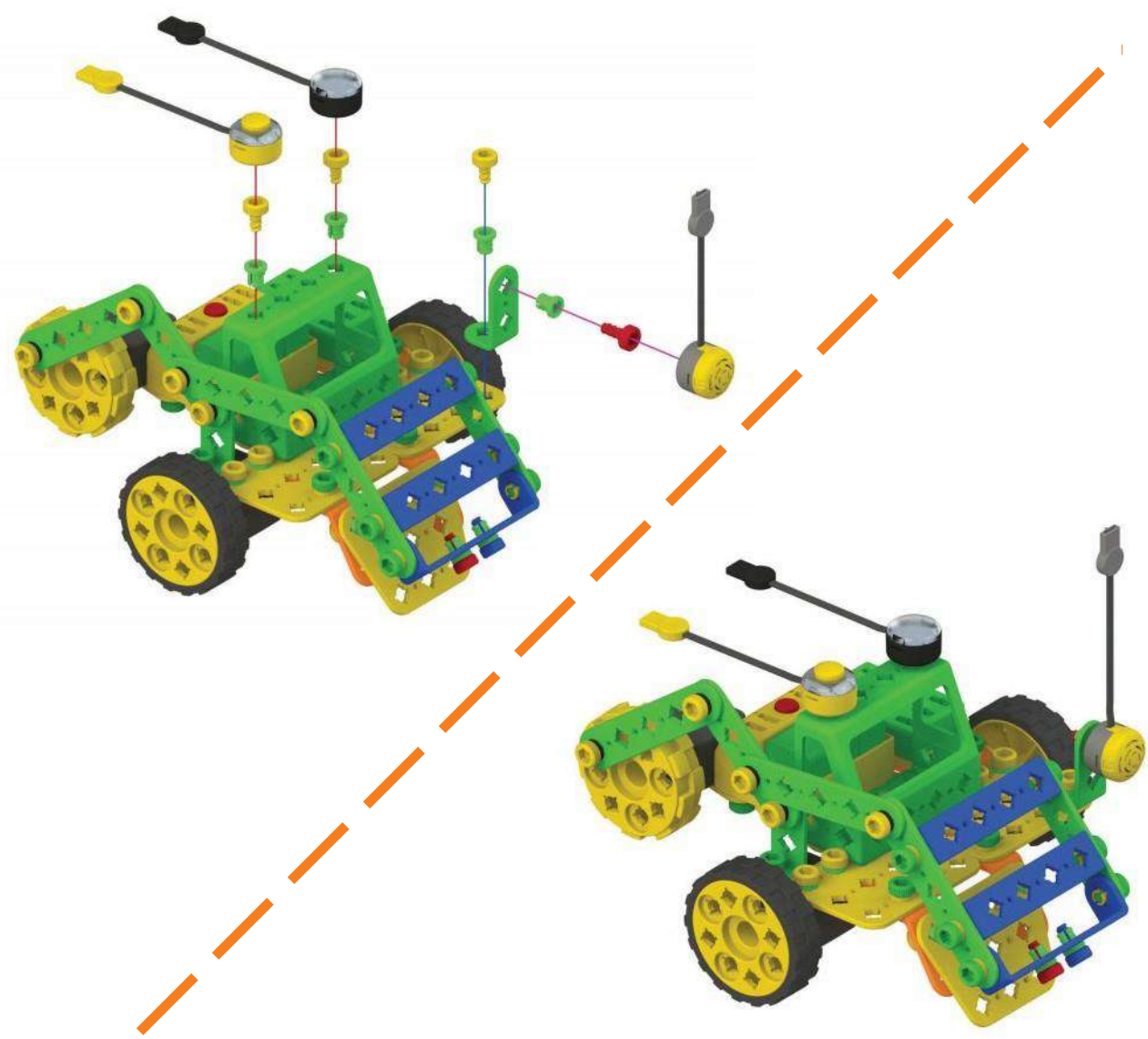

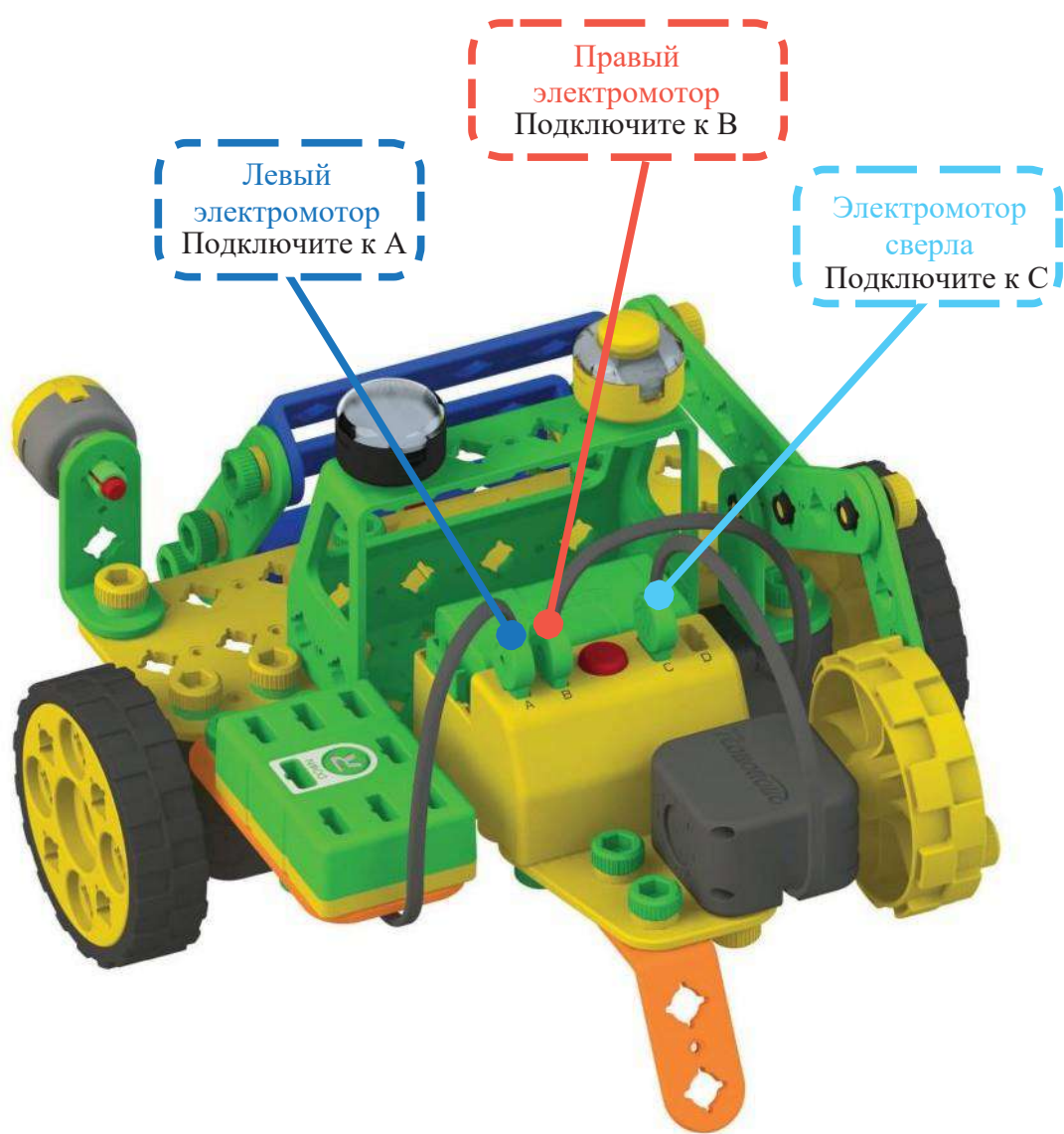
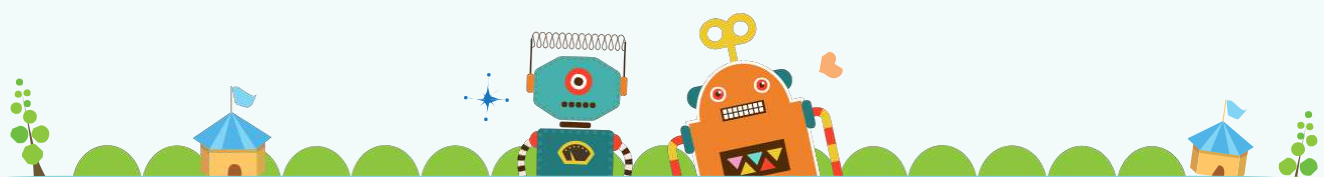

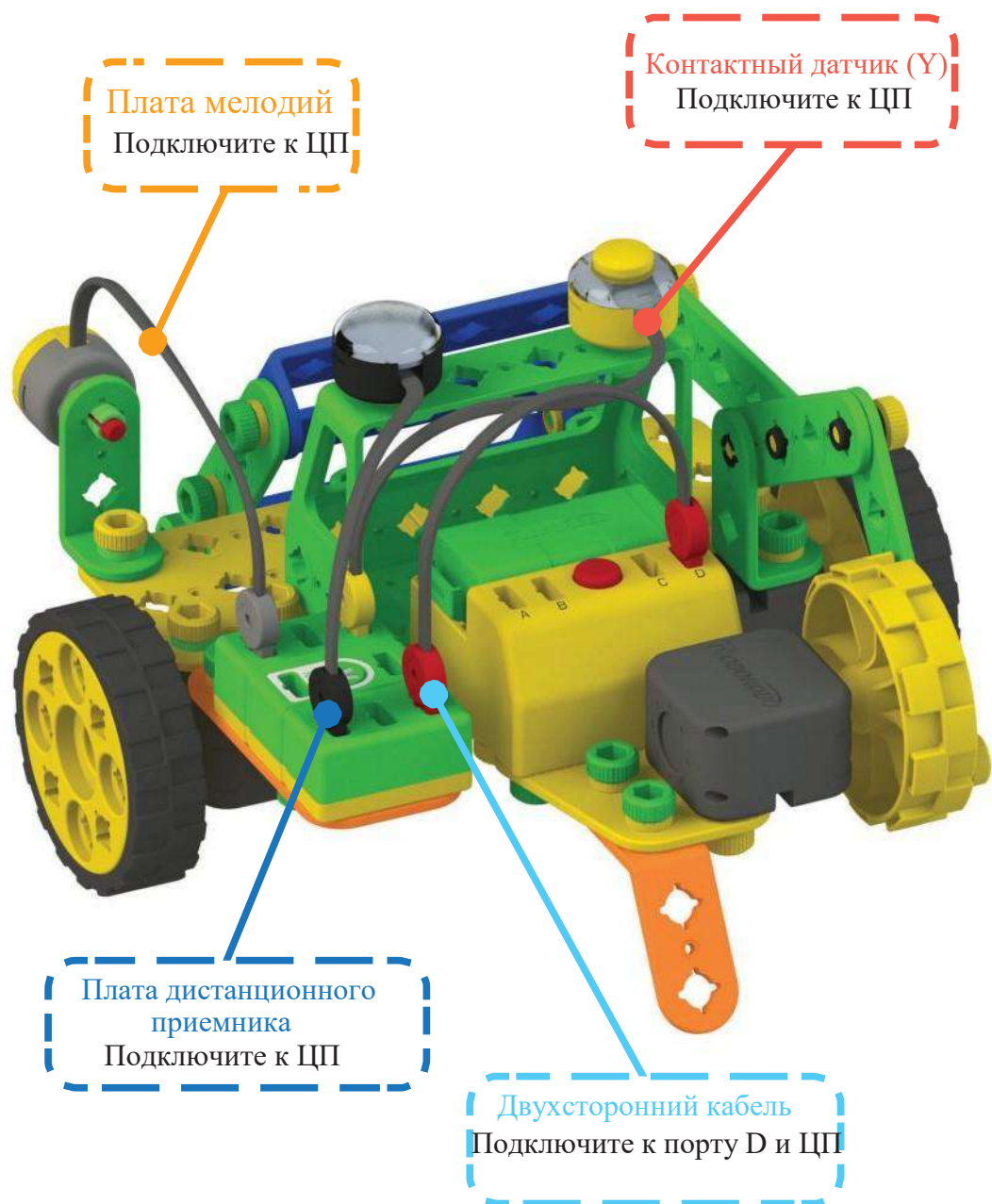



Запрограммируем движение робота исследователя на программной плате.



Управляйте роботом-исследователем с помощью устройства дистанционного управления



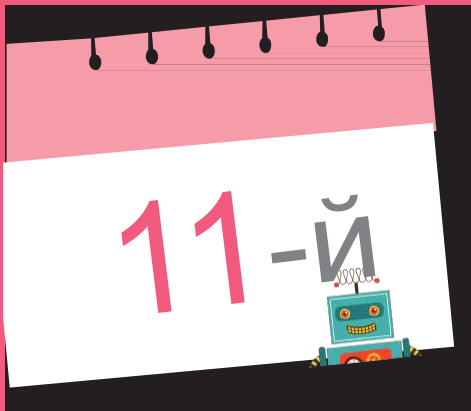

Сыграем с военным роботом!



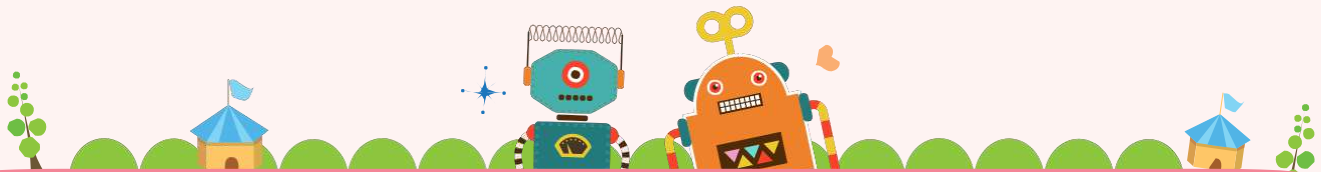

## Детали



x2



x1



x4



x4

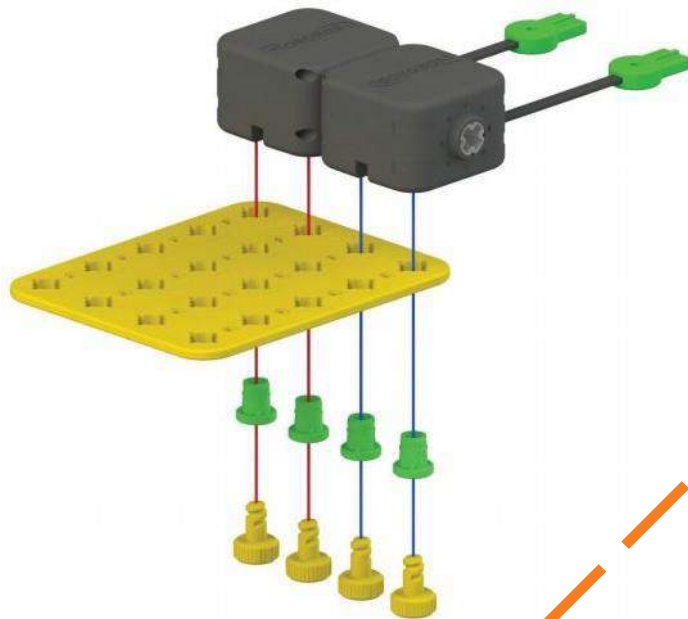

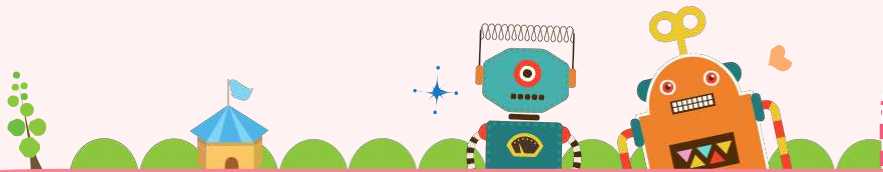

2

Детали



x2



x2



x2

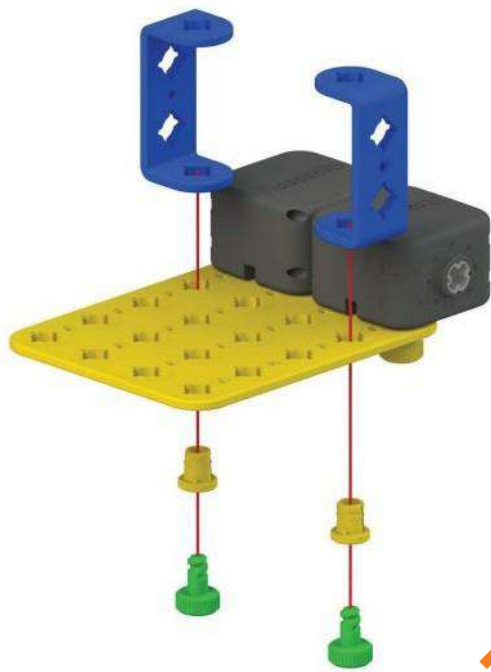

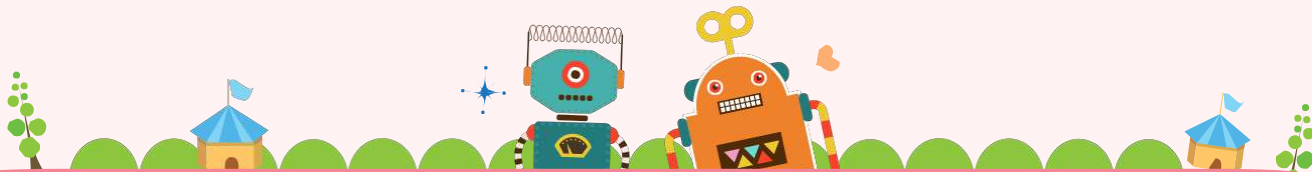

3

Детали



x1



x1



x2



x2



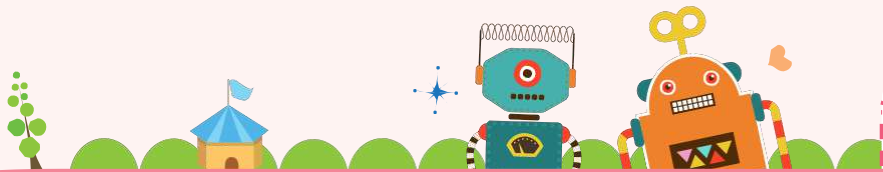

4

Детали



x2



x2



x2



x2



x2

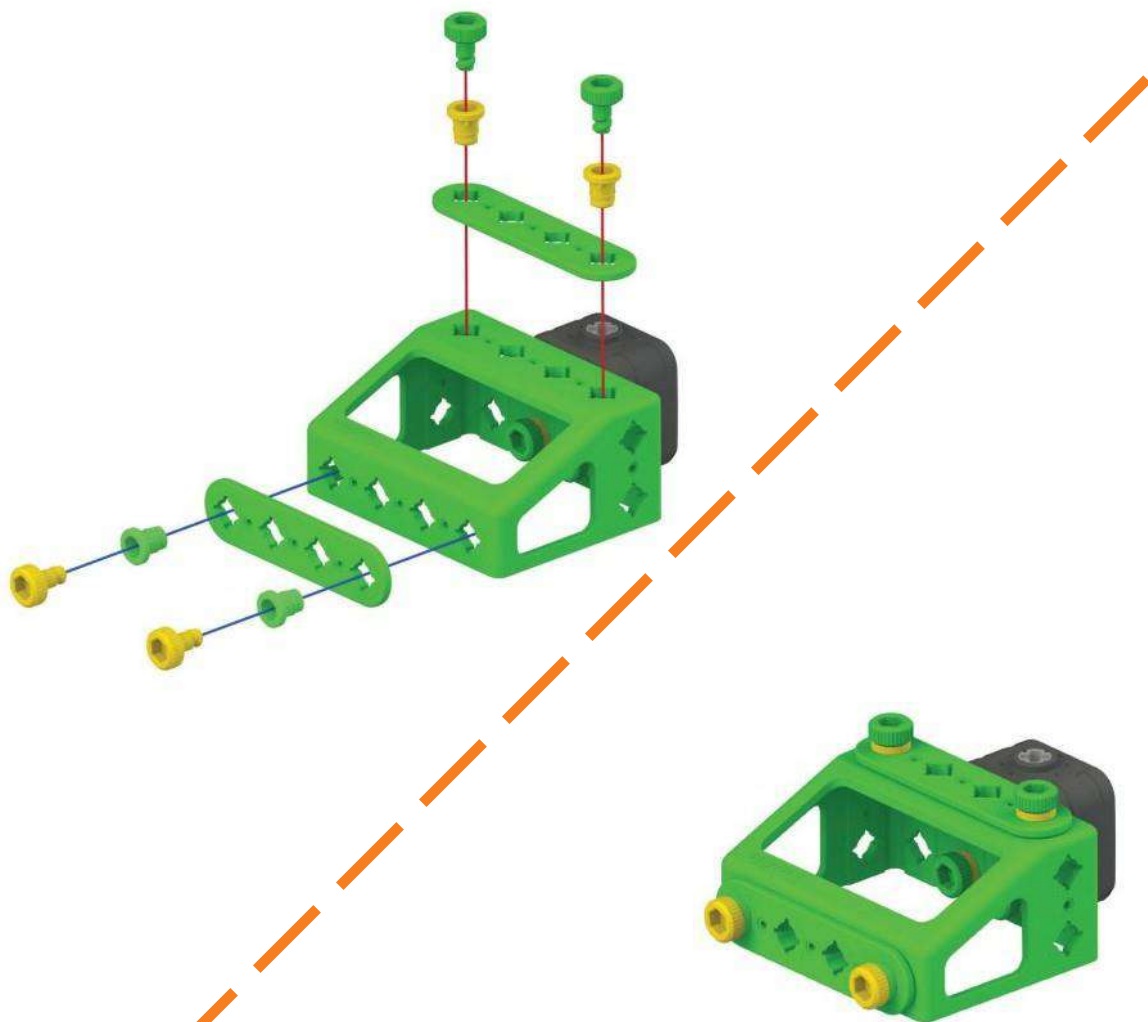

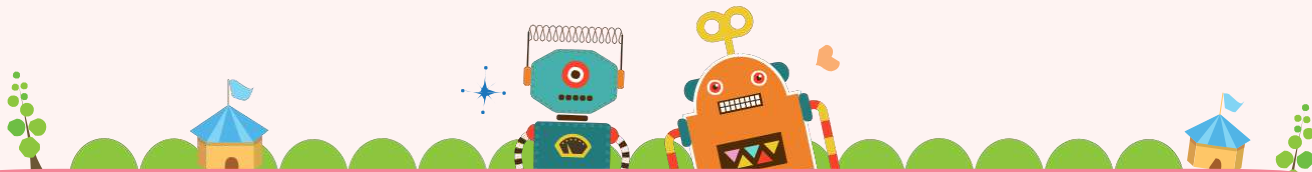

5

Детали



x2



x2



x2

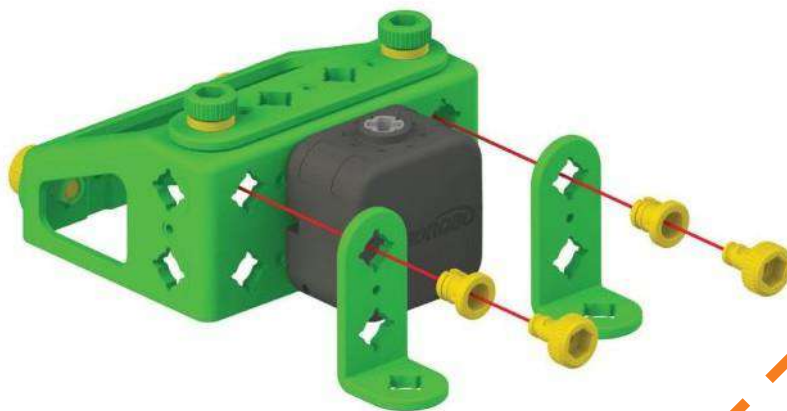

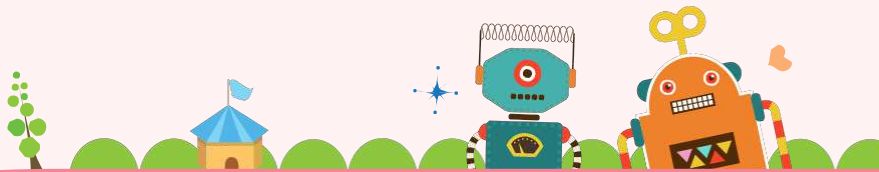

6

Детали



x2



x2

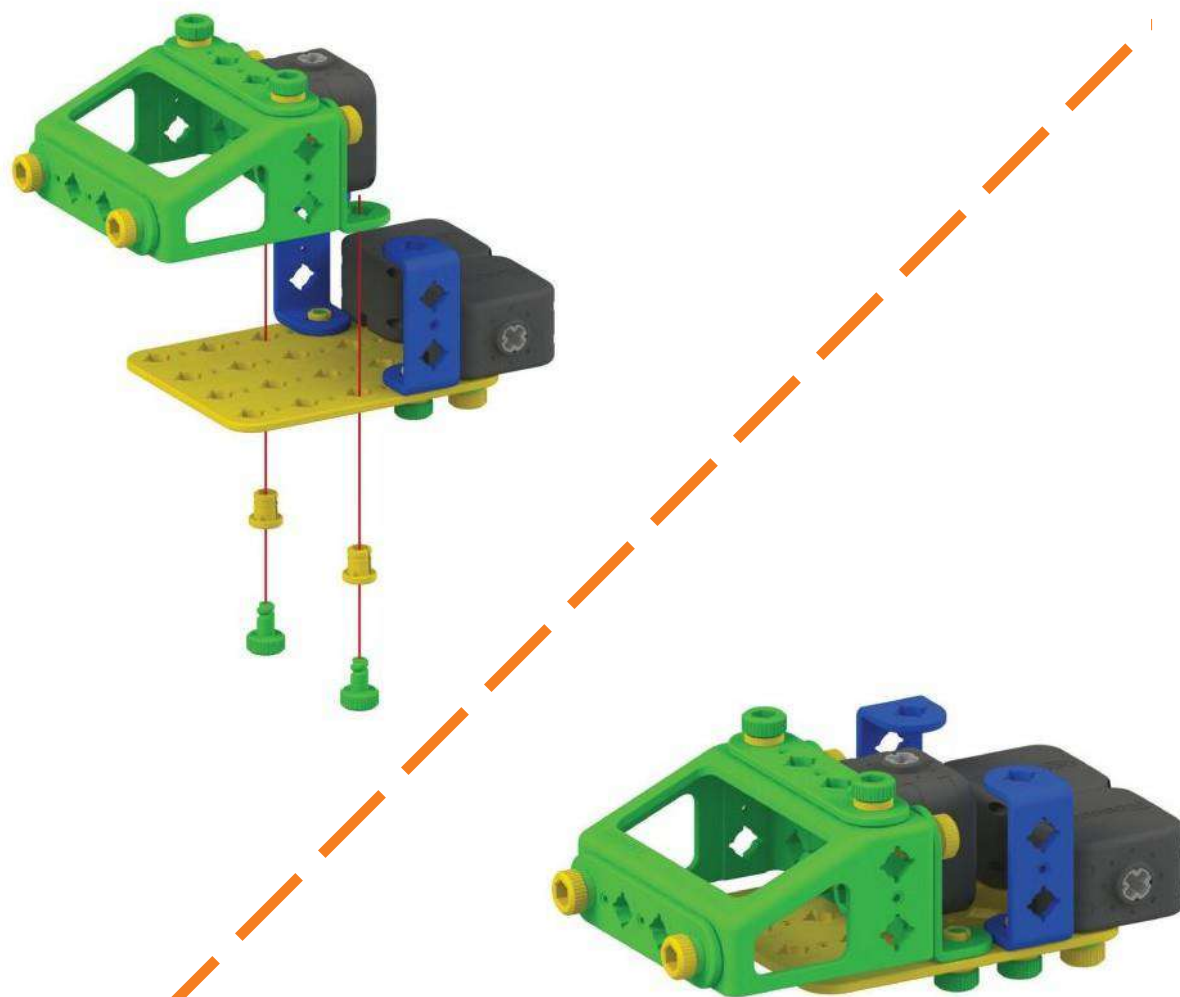

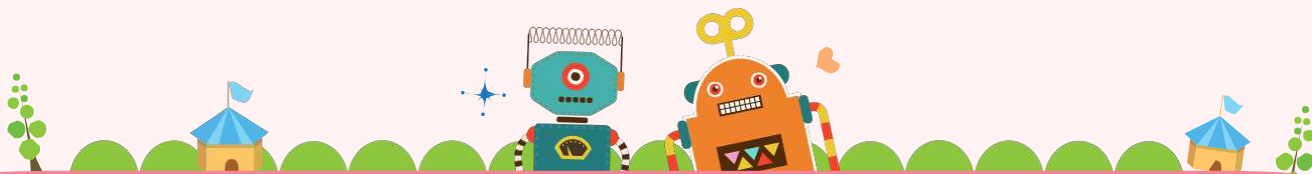

Детали



x2



x2



x2



x2

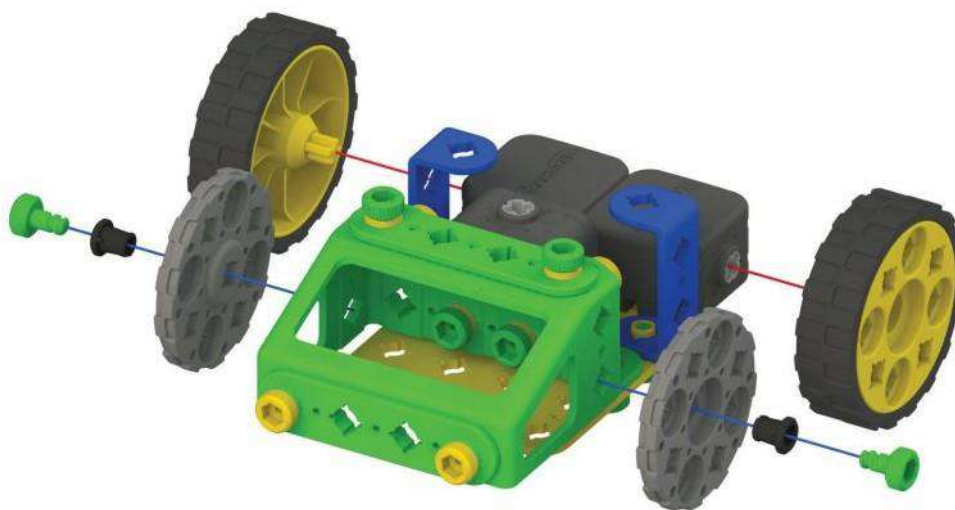



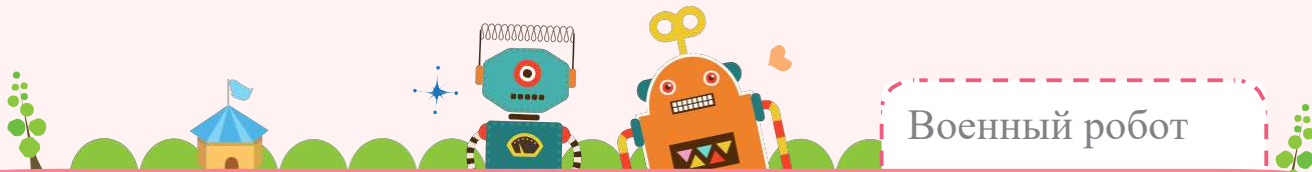

8

Детали



x2



x4



x2



x2



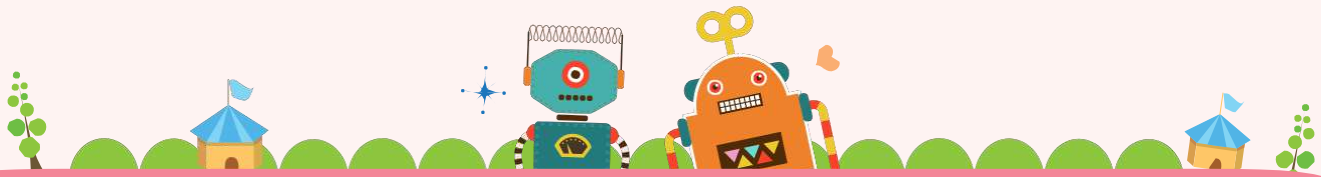

9

Детали



x1



x1



x2



x2



x2



x2



x2

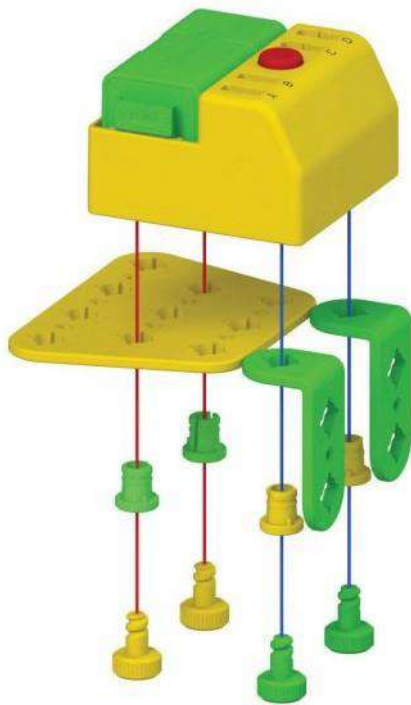

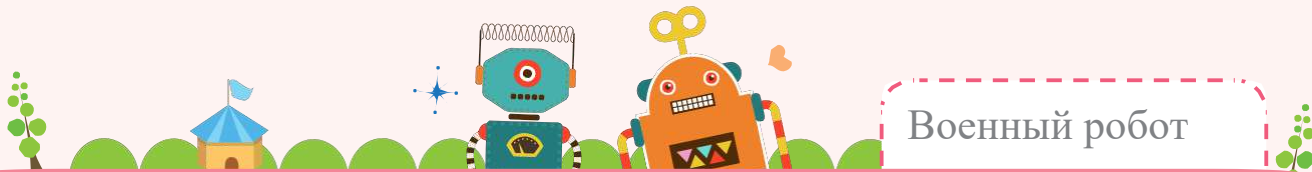

10

Детали



x1



x2



x2

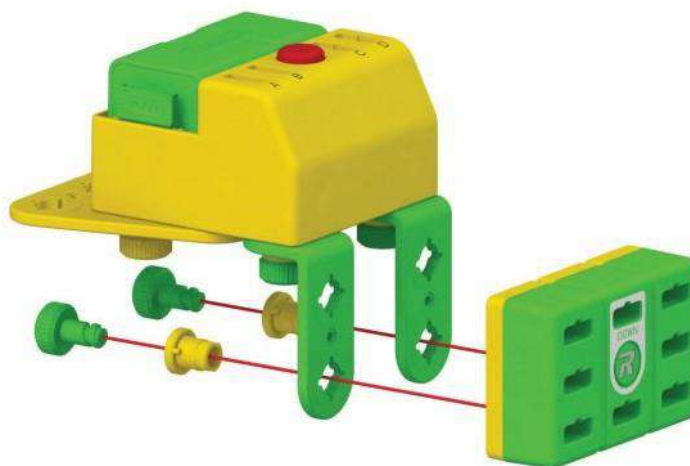

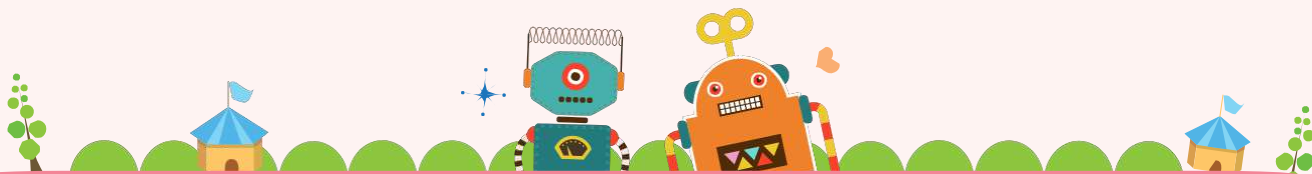

Детали



x2



x2

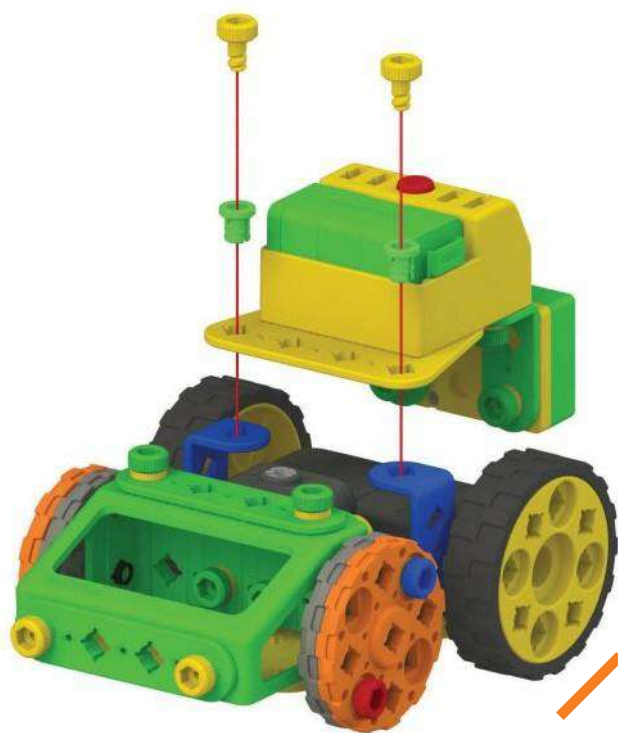

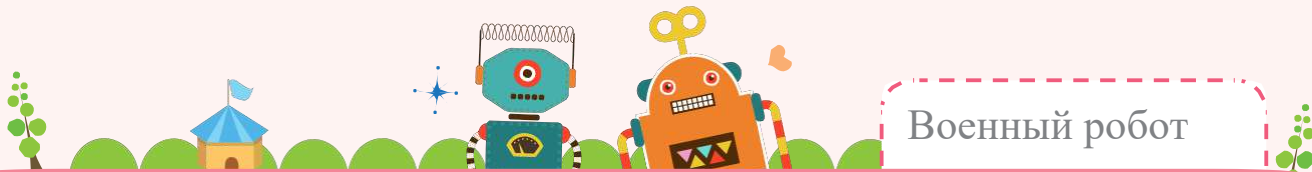

12

Детали



x1



x1



x1



x2



x2



x2



x1



x1

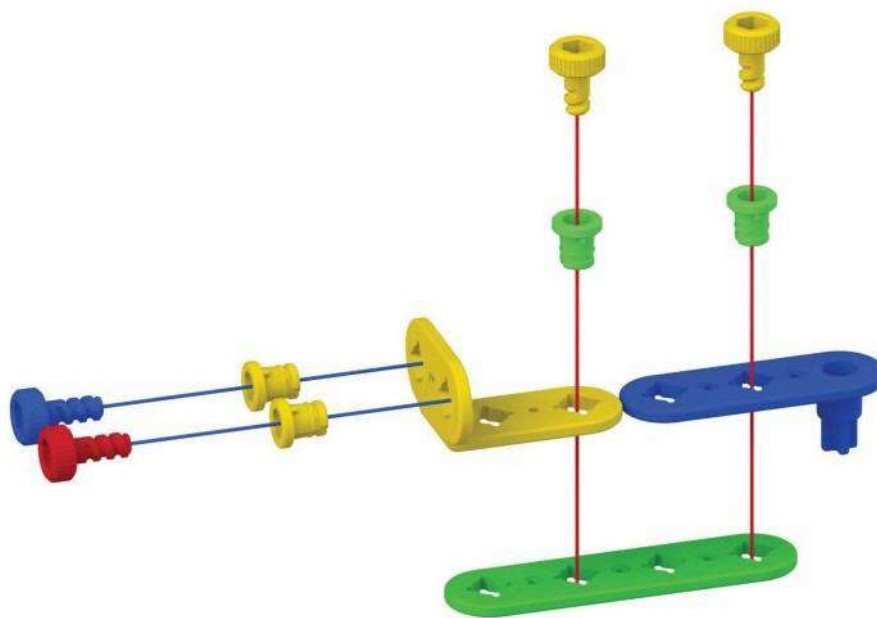

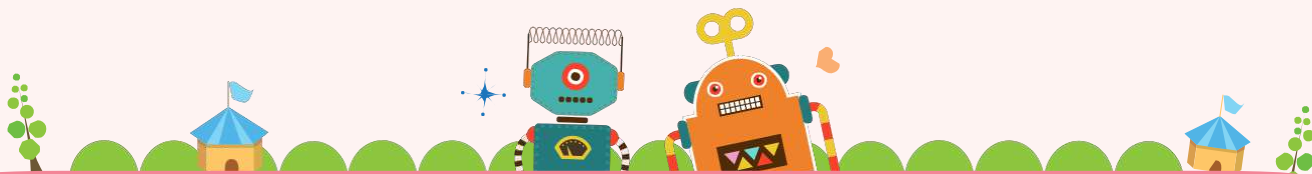

13

Детали



x1



x1



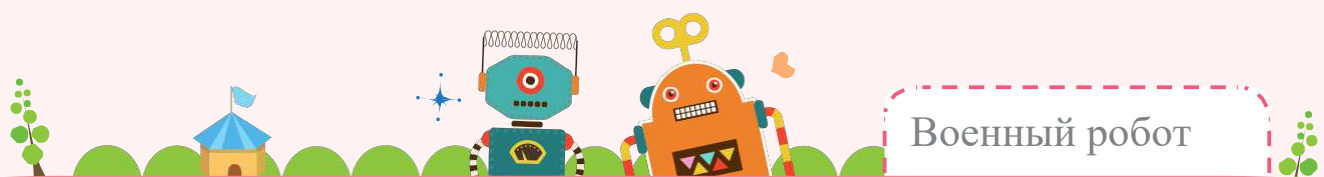

Военный робот

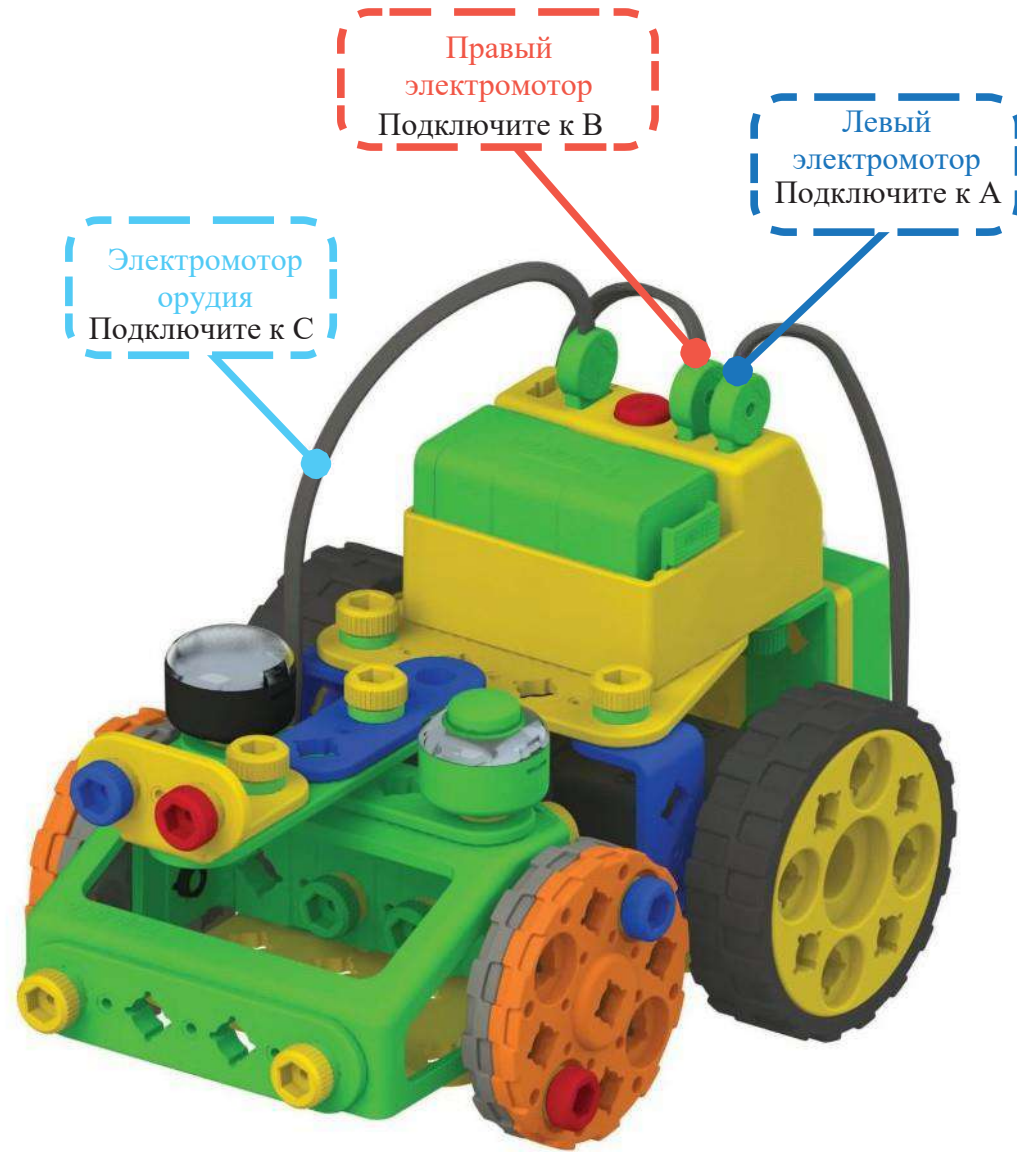

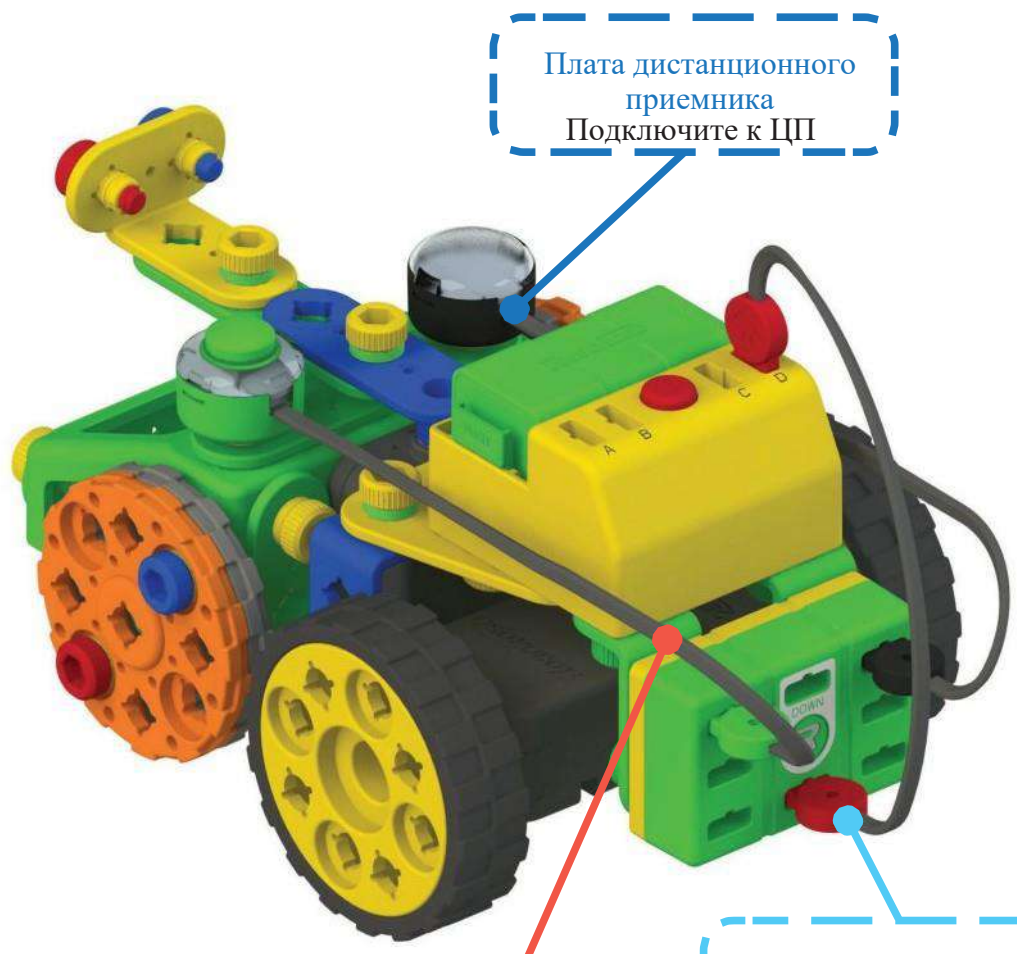
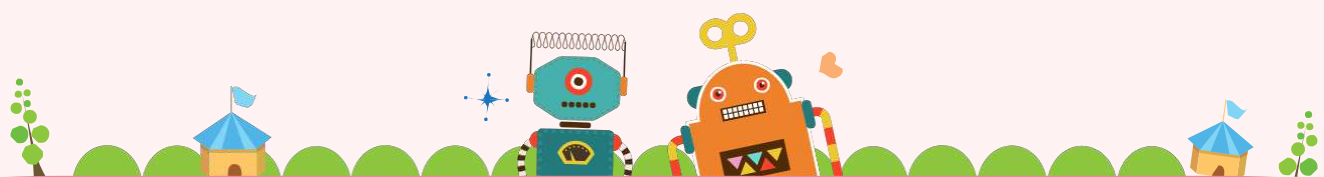

Плата дистанционного  
приемника  
Подключите к ЦП

Контактный датчик (G)  
Соедините порт D  
с ЦП

Двухсторонний кабель  
Подключите к ЦП





Запрограммируем движение военного робота на программной плате.



Управляйте военным роботом с помощью устройства дистанционного управления

12-й

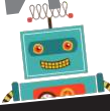

Сыграем с роботом-гуманоидом!



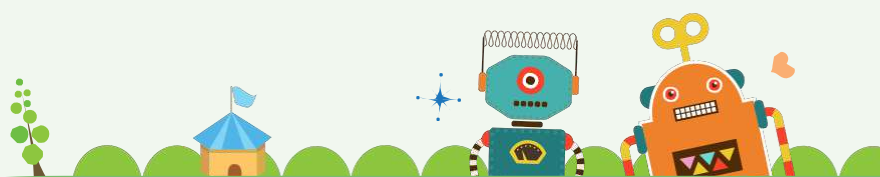

Детали



x2



x1



x4



x4

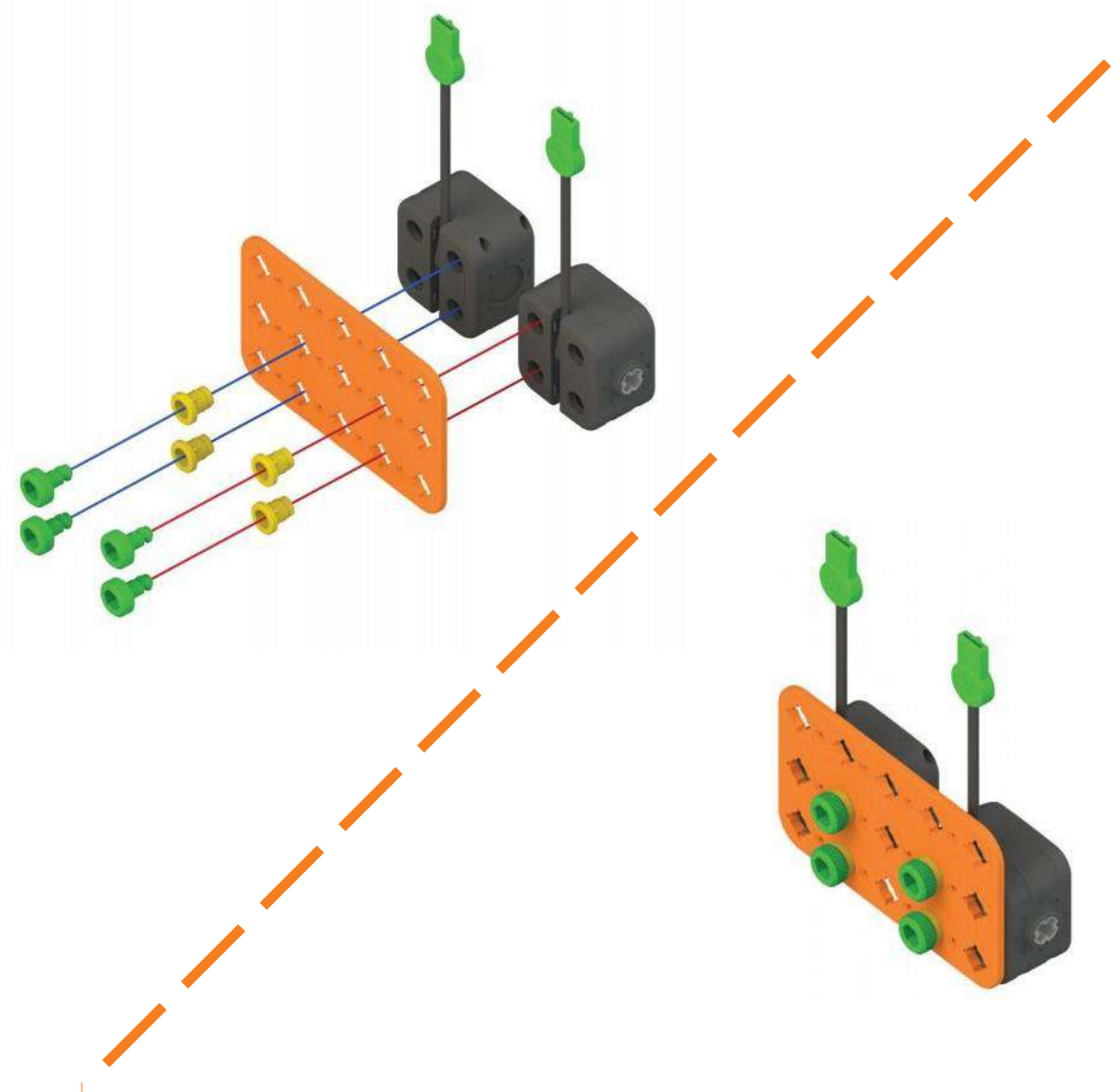

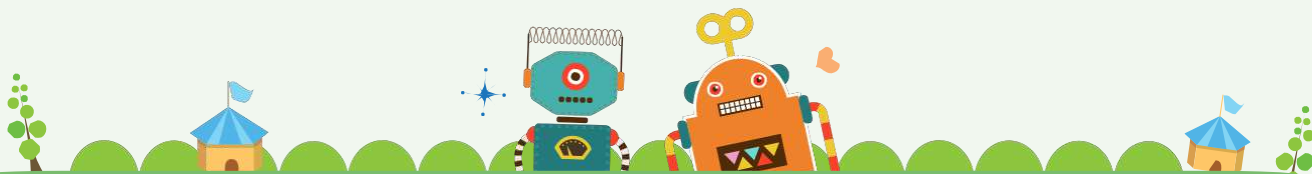

2

Детали



x4



x2



x2

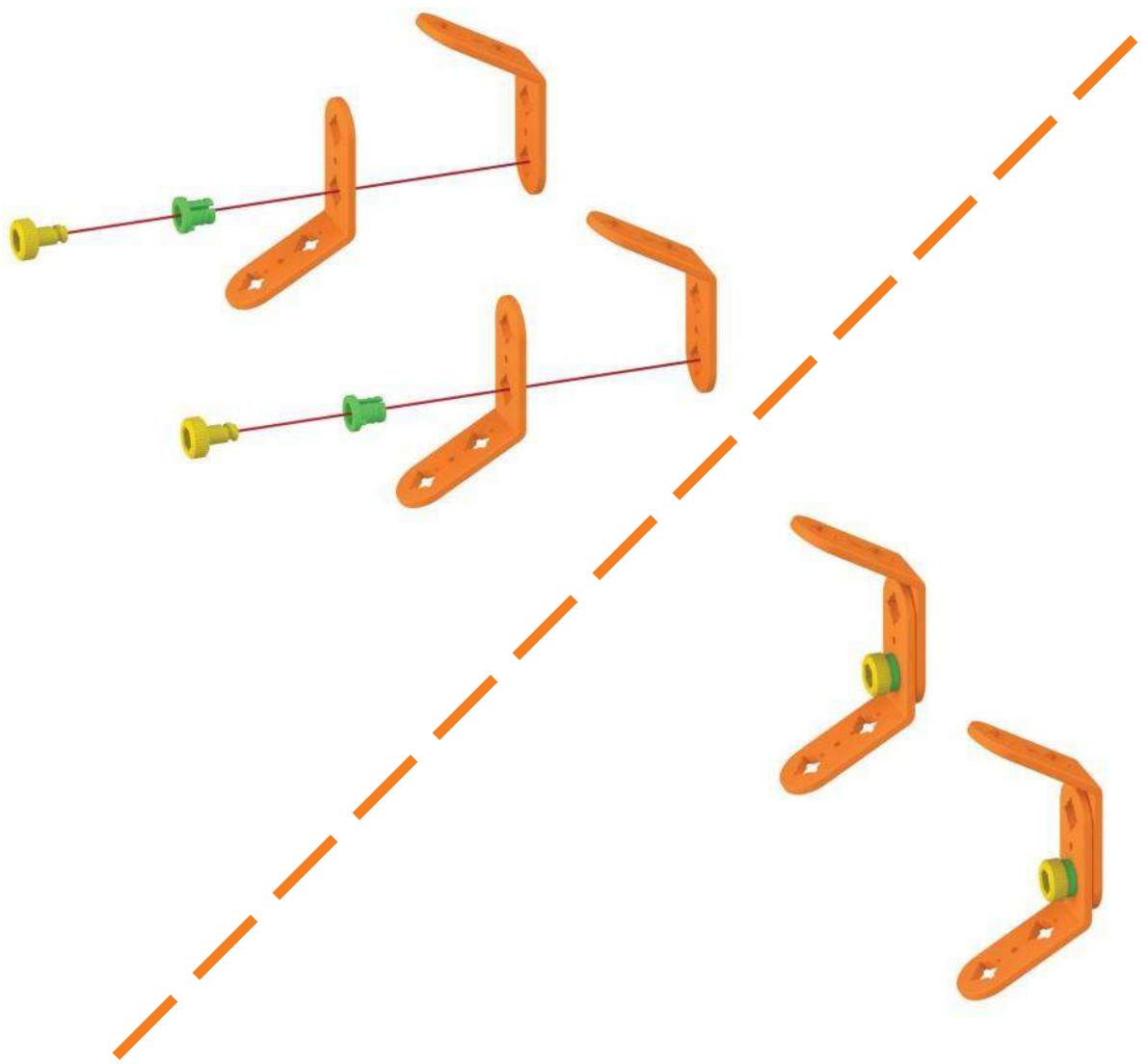

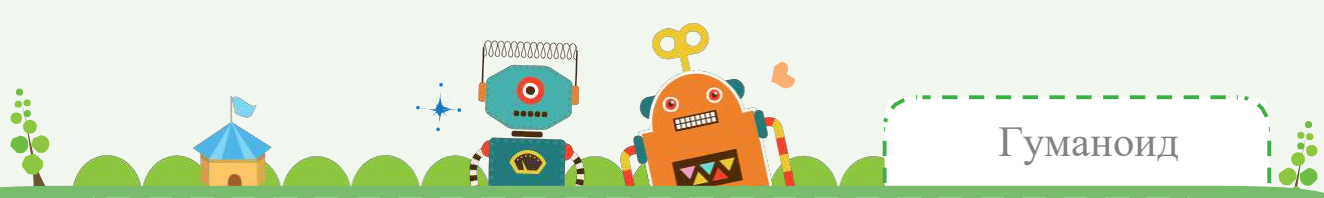

3 Детали

-  x1
-  x1
-  x3
-  x3
-  x1

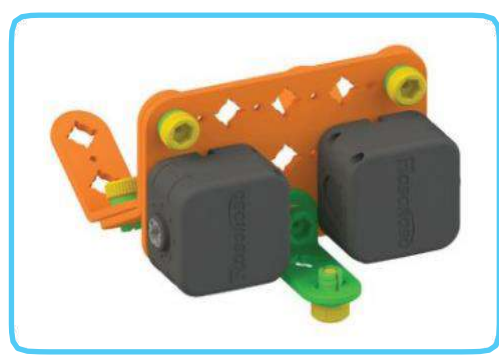
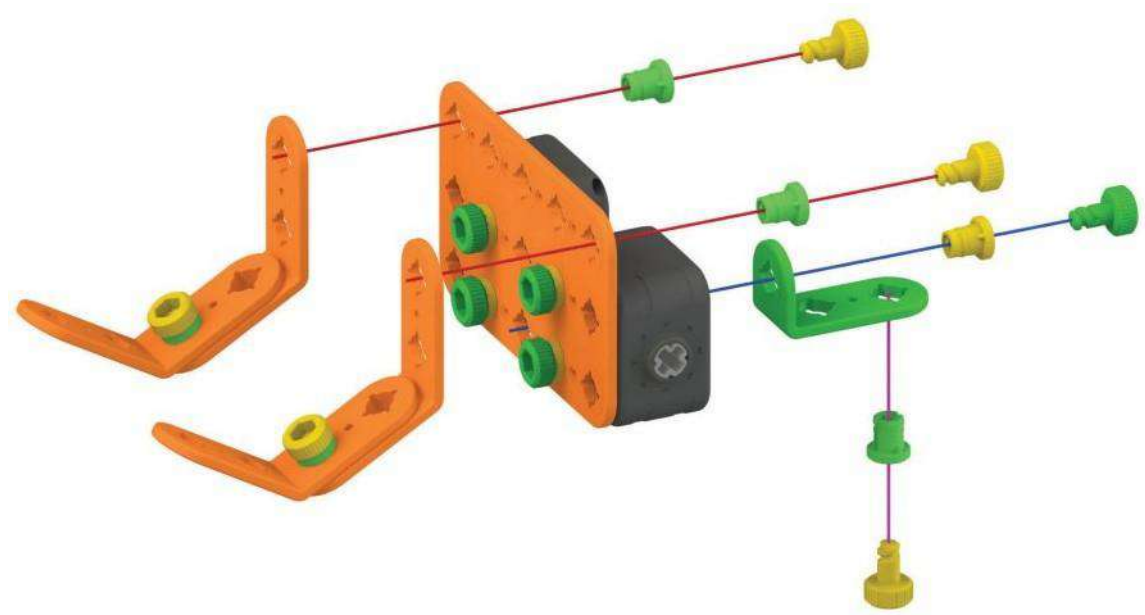

<Задняя сторона>

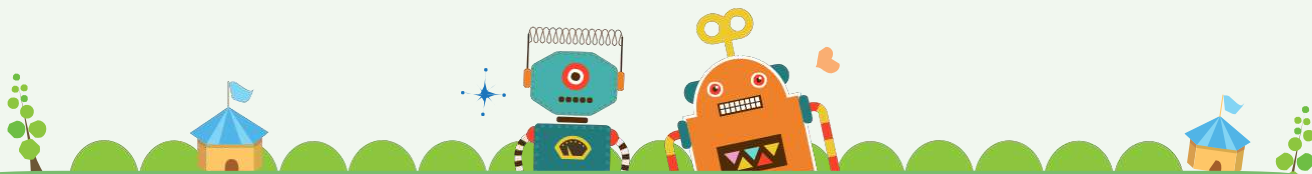

4

Детали



x1



x1



x2



x2

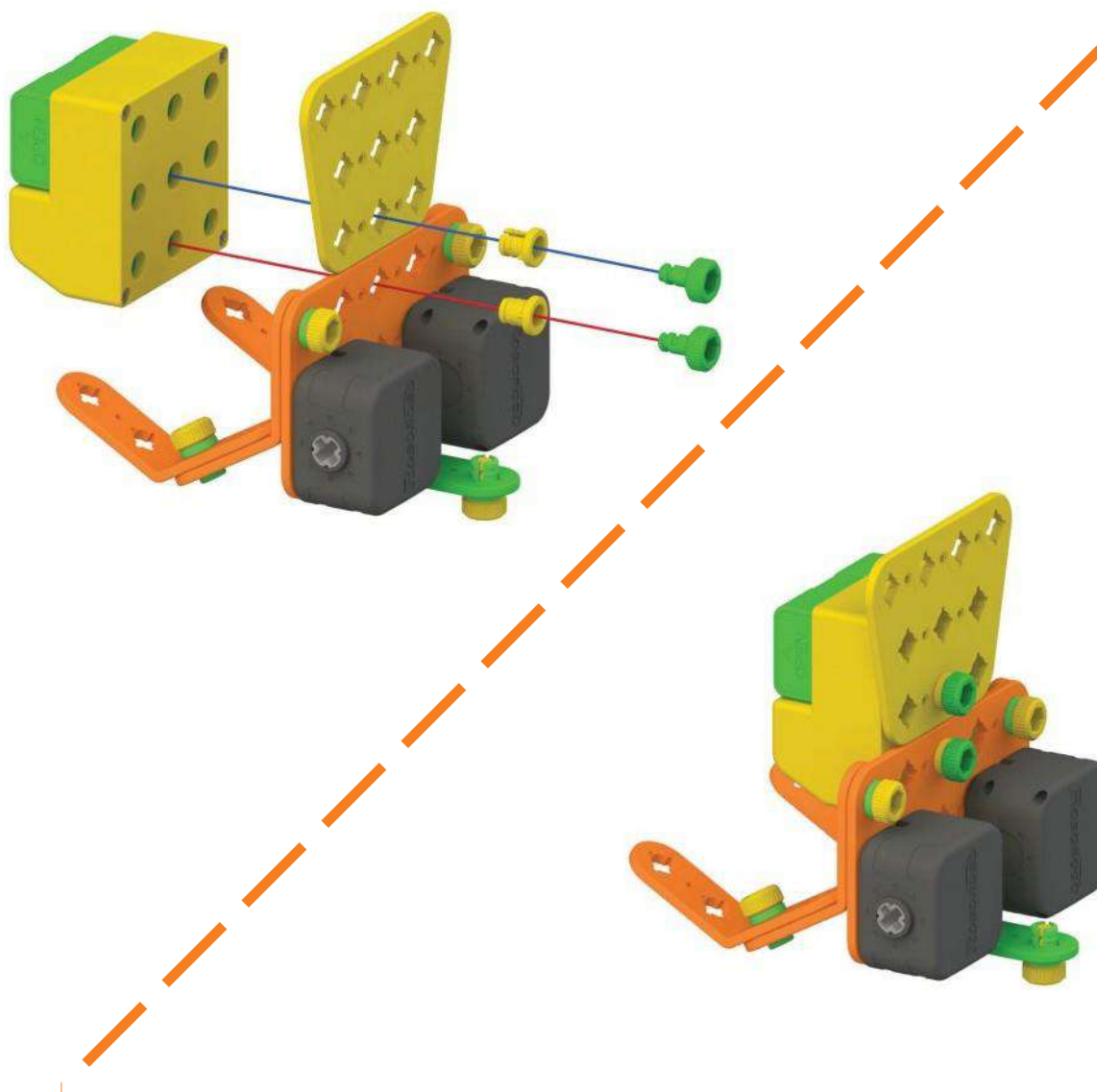

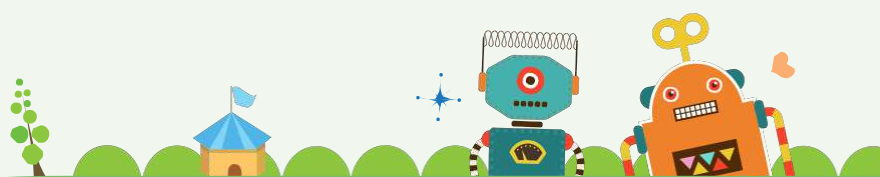

5 Детали



x1



x2



x2

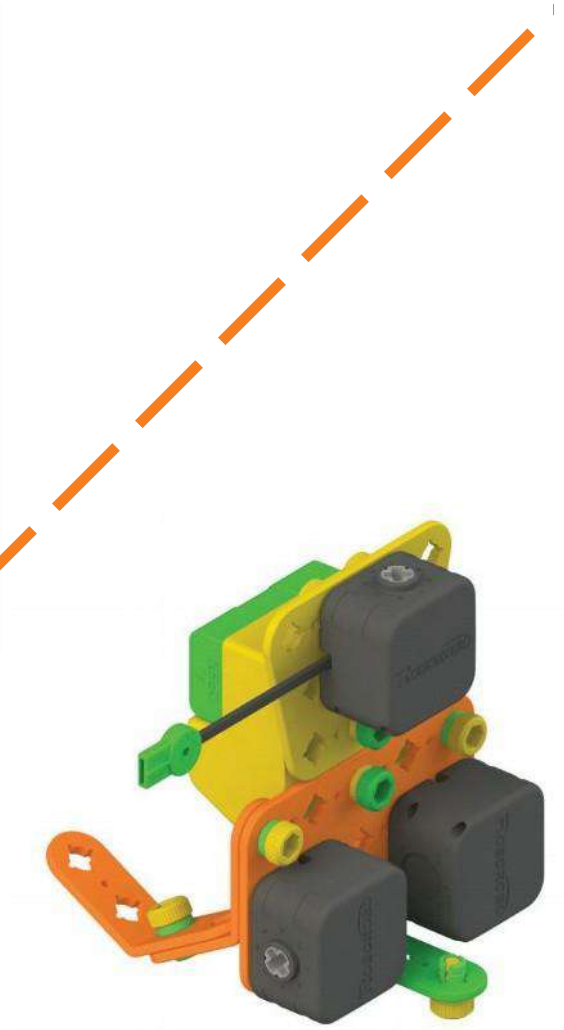
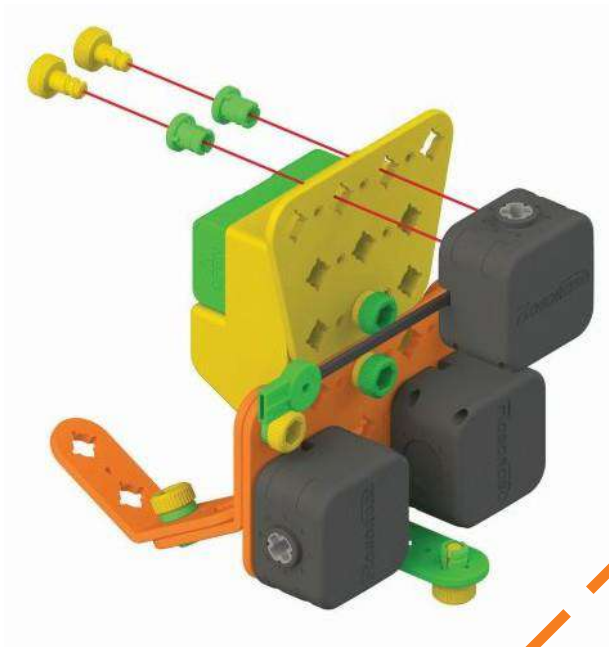

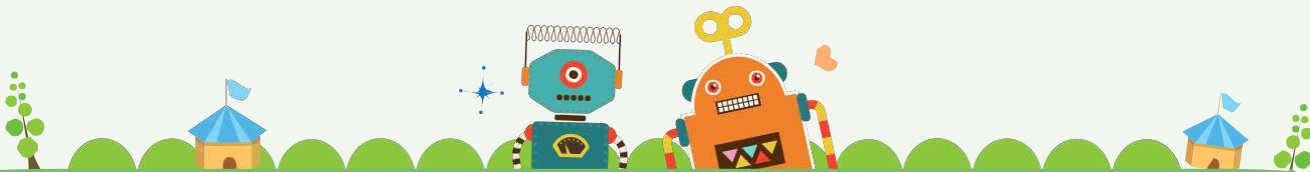

6

Детали



x2



x2



x2

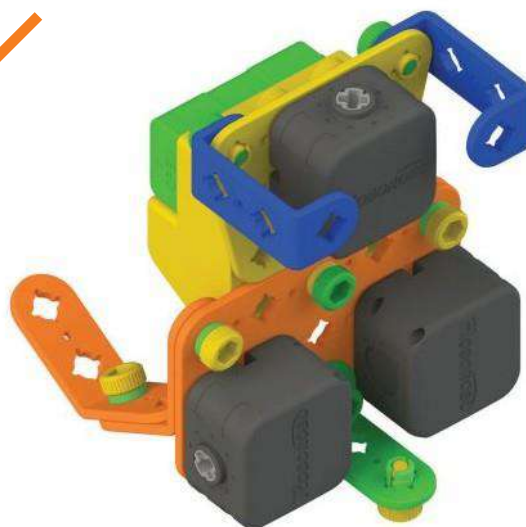
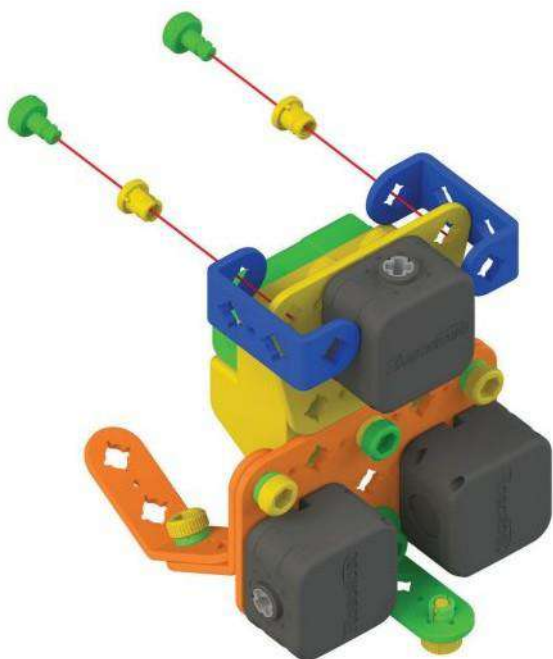





Детали



x1



x1



x2



x2

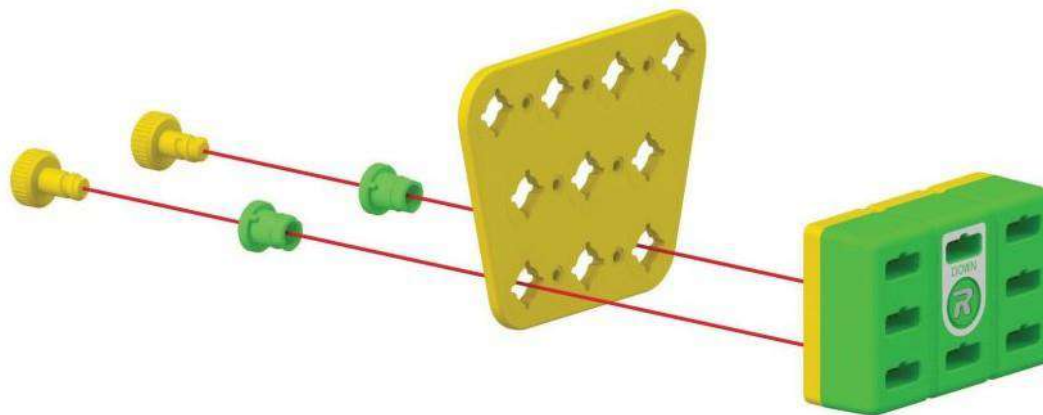

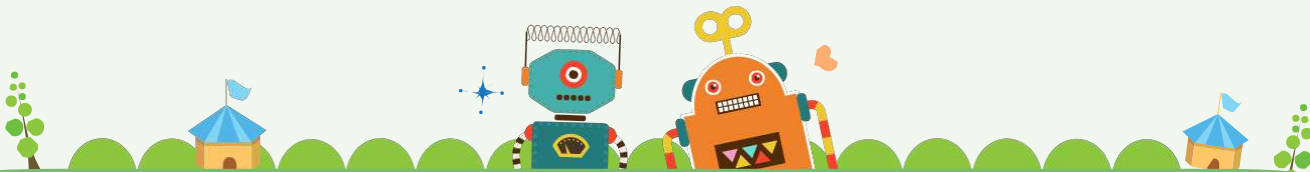

8

Детали



x2



x2

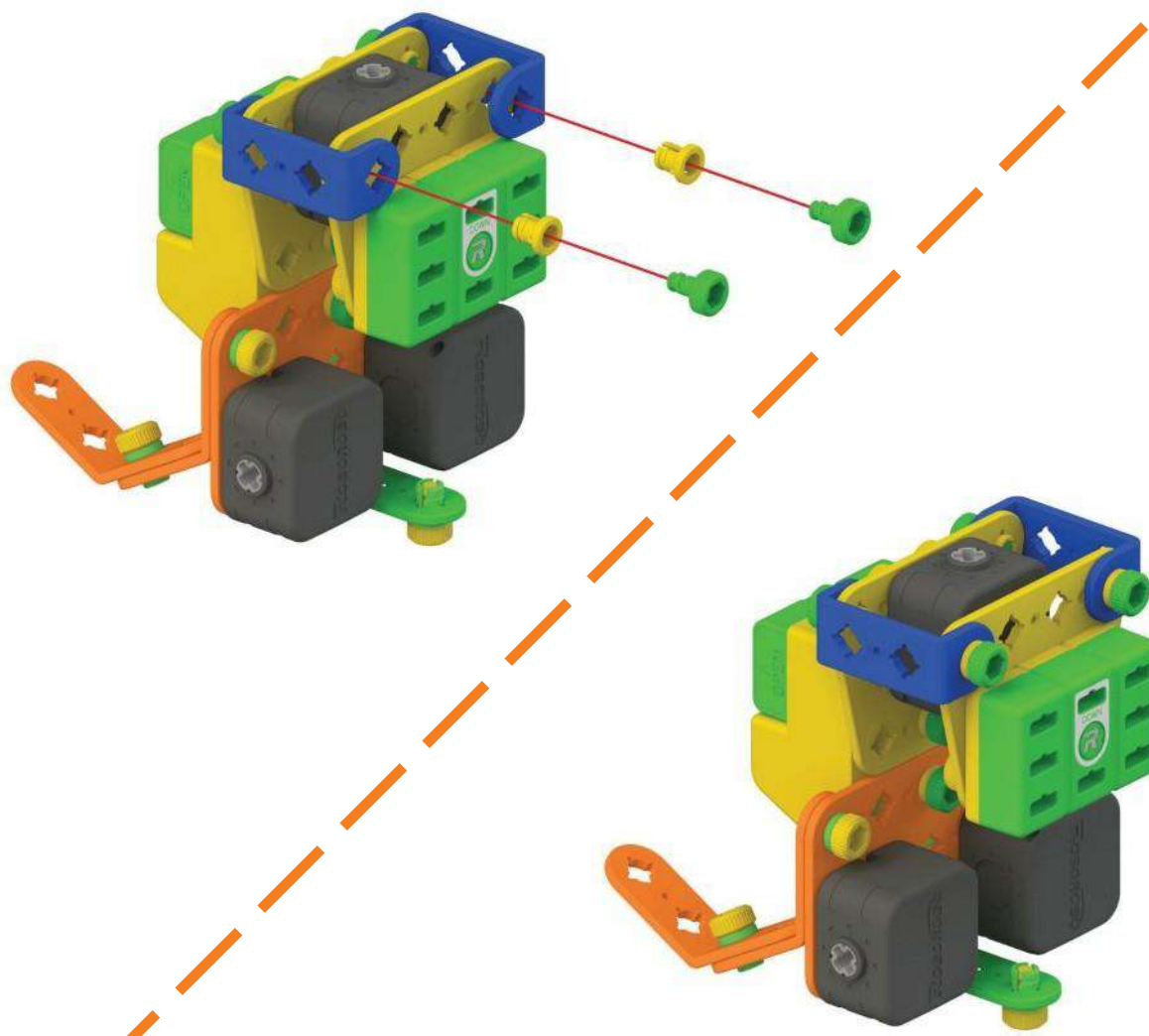

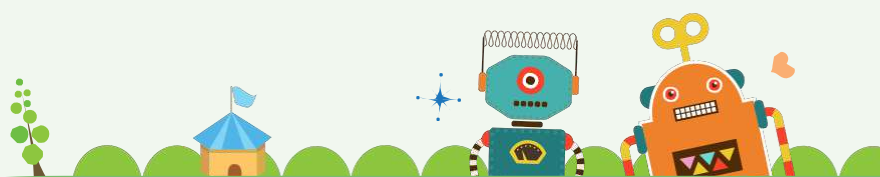

9

Детали



x2



x2



x2



x4



x4

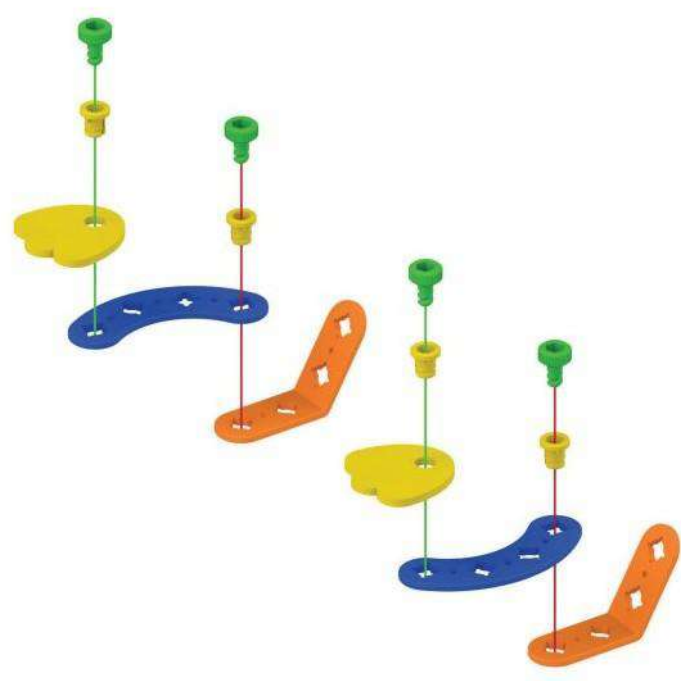

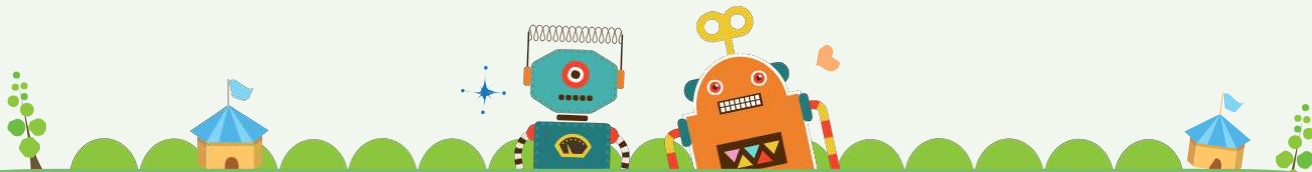

10 Детали



x1



x1



x2



x2

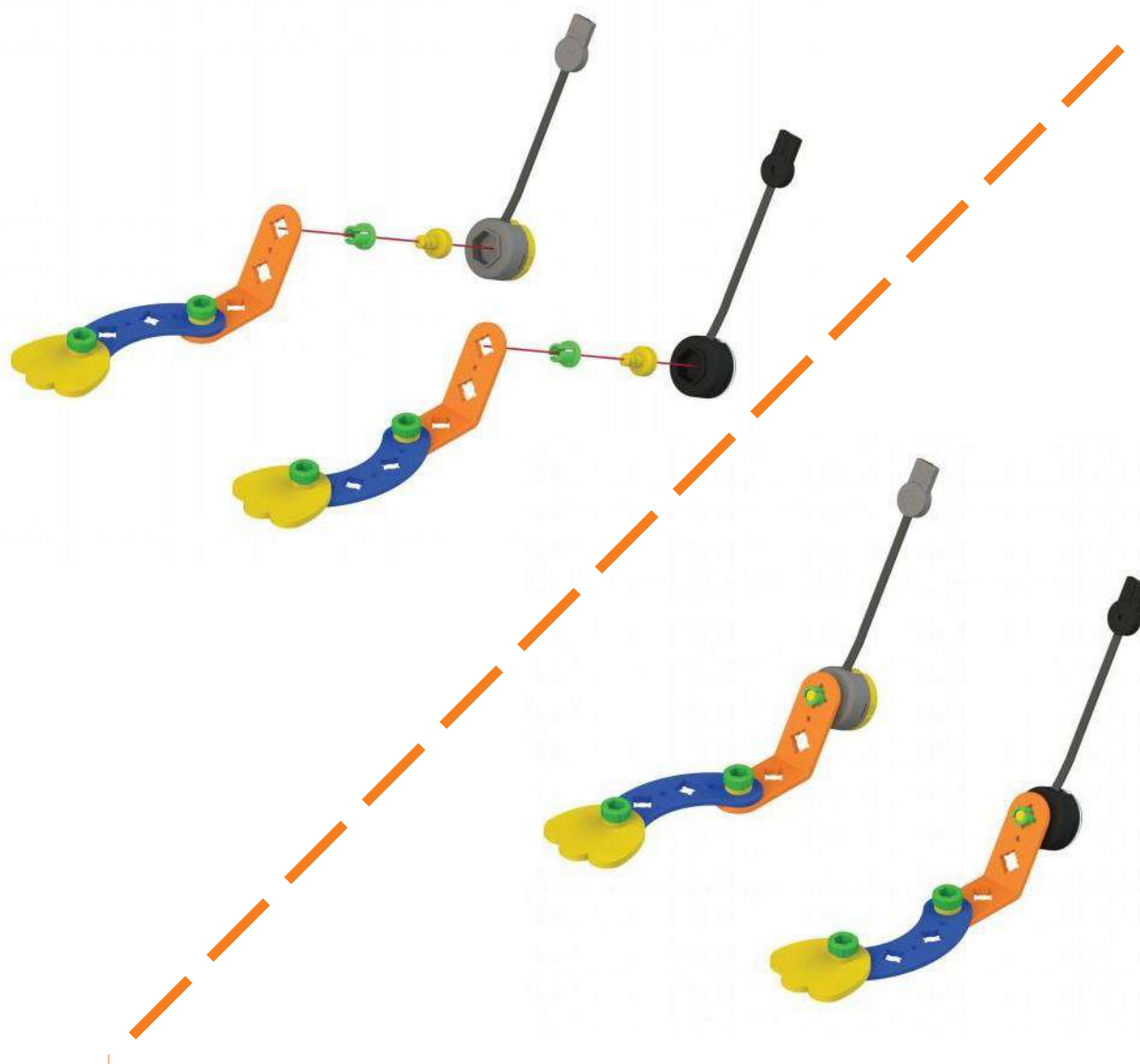

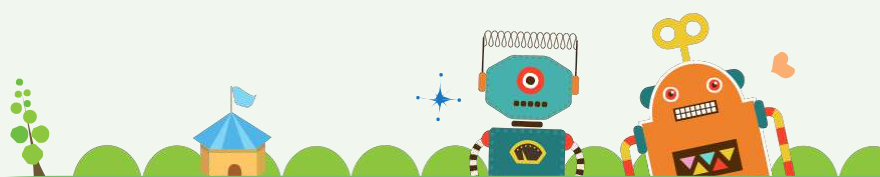

Детали



x1



x1



x2



x2

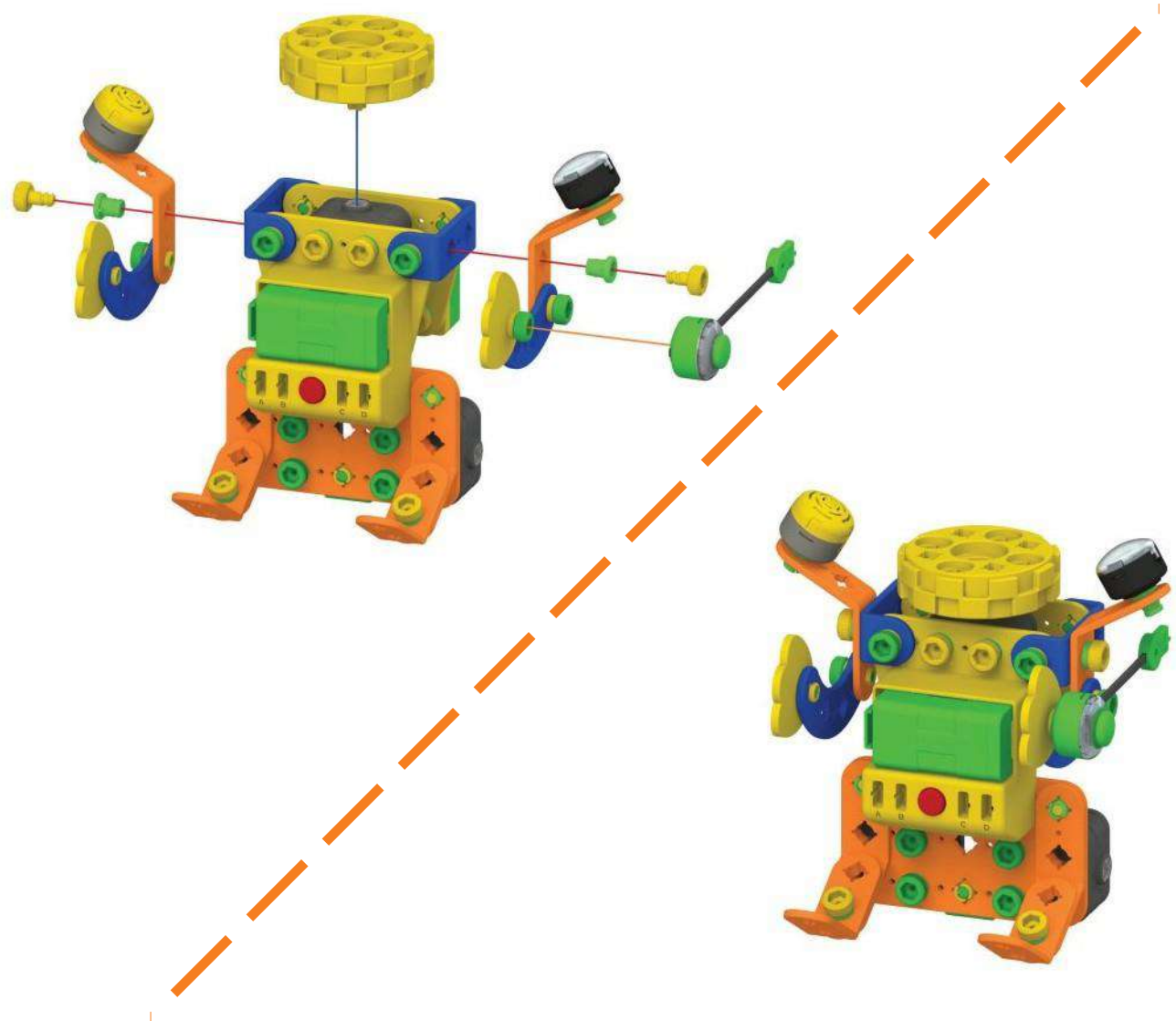

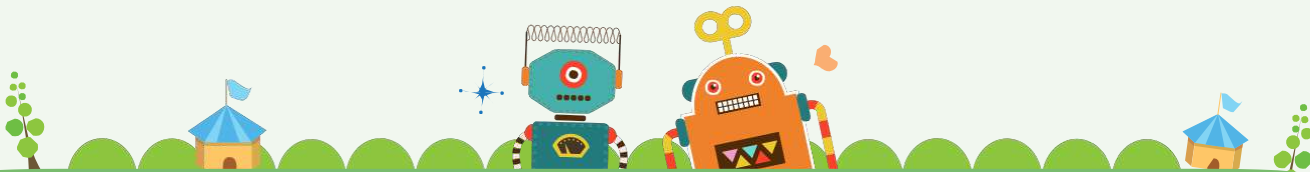

12

Детали



x2



x2



x2

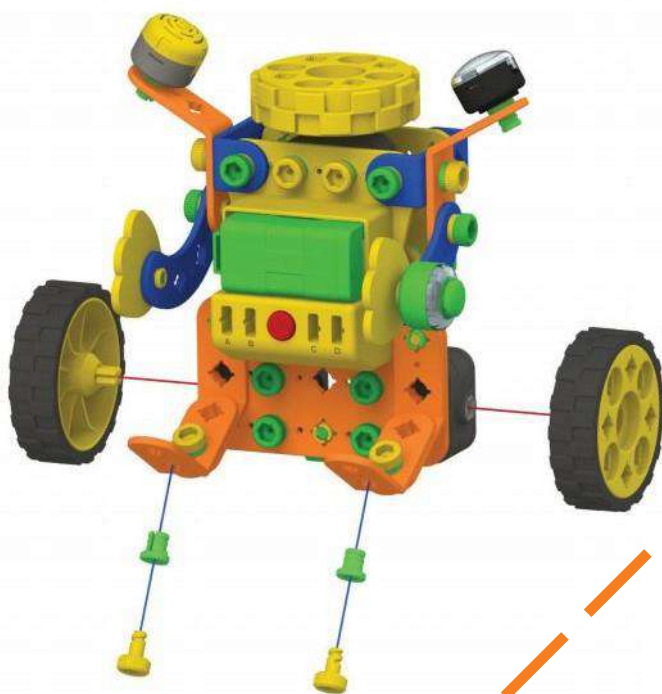

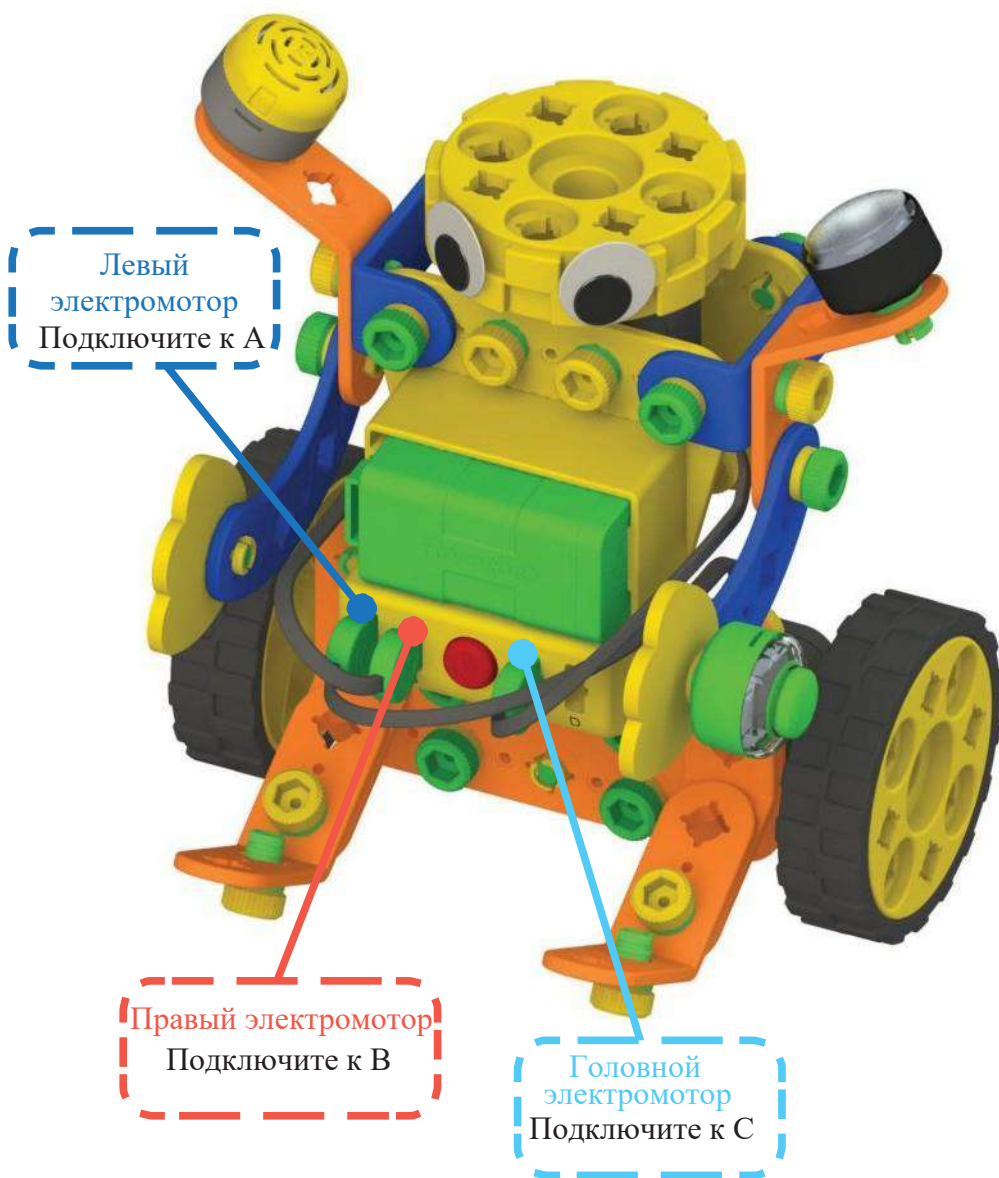

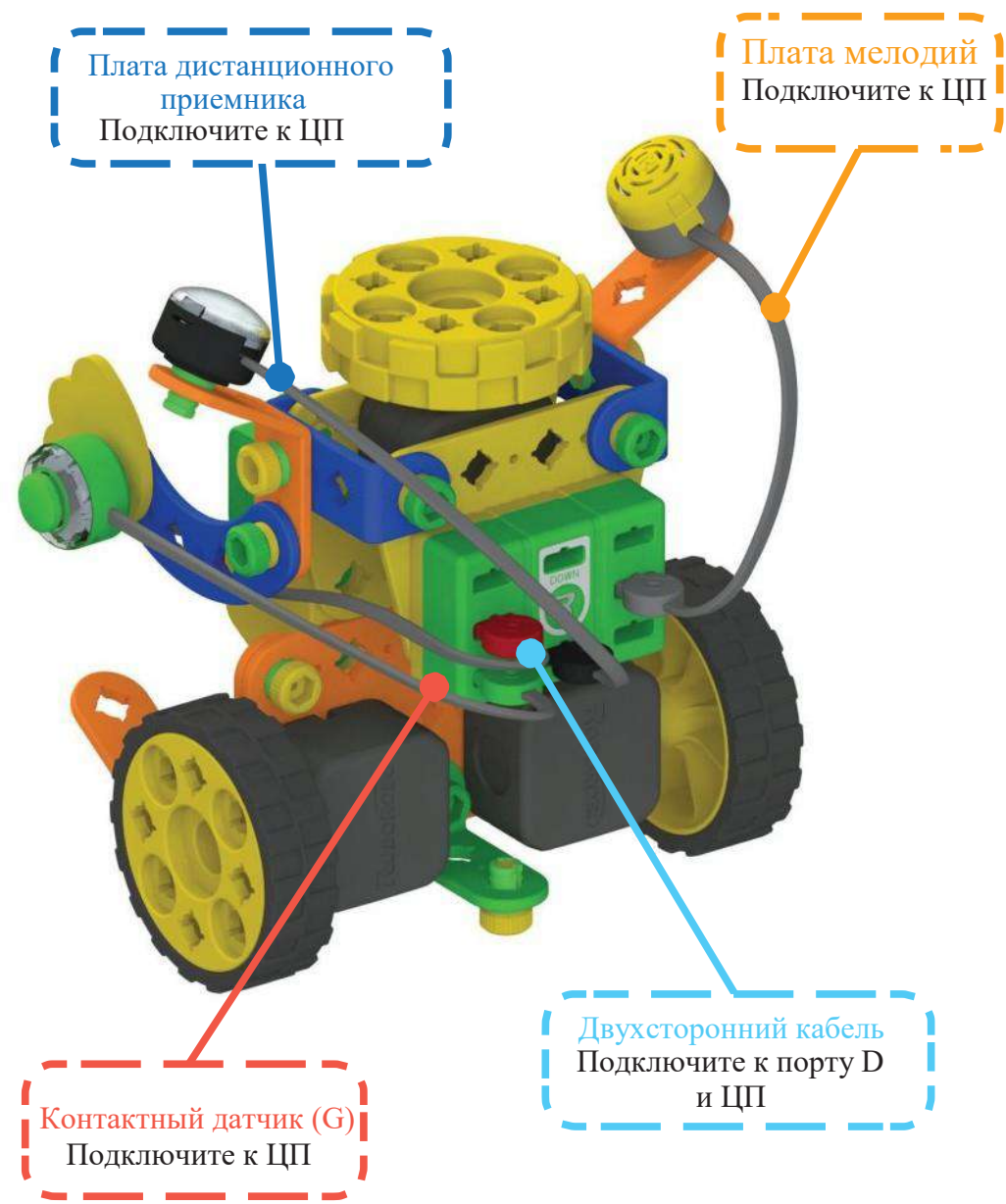
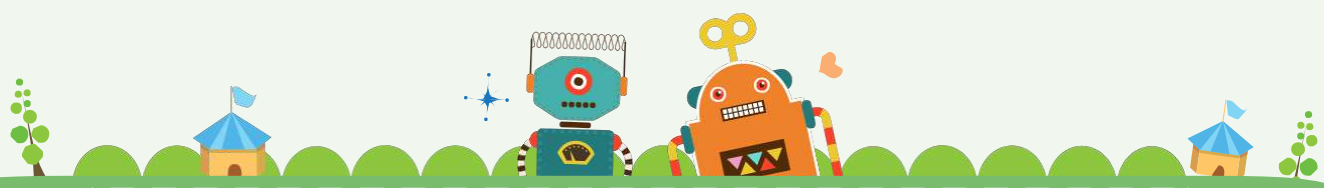



Создадим  
Программу

Запрограммируем движение военного  
робота на программной плате.



Управляйте военным роботом с помощью устройства  
дистанционного управления



## Украшение блоков

Вы можете присоединять блоки к роботам с помощью блочных рам. Попробуйте украсить роботов с помощью дополнительных блоков!



Рама 4 блока



Рама 8 блоков

Соберите блочные рамы, как показано ниже

- Для сборки блочных рам лицевой стороной ВВЕРХ



- Для сборки блочных рам лицевой стороной ВНИЗ





# Украшение блоков

## 1. Как закрепить блочную раму

Для закрепления одной блочной рамы, поместите гайку в отверстие блочной рамы так, чтоб кромки гайки плотно вошли между

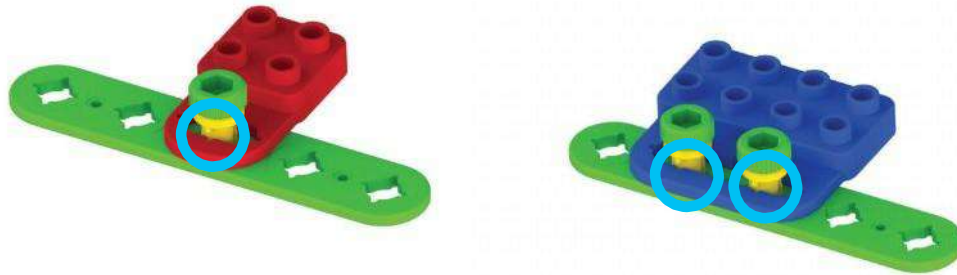

## 2. Как собрать подвижную блочную раму

При установке блока над блочными рамами, наличие подвижной блочной рамы позволяет настроить положение блочной рамы. Чтобы собрать настраиваемую блочную раму, поместите гайку в отверстие блочной рамы так, чтобы кромки гайки не плотно входили в отверстие рамы.

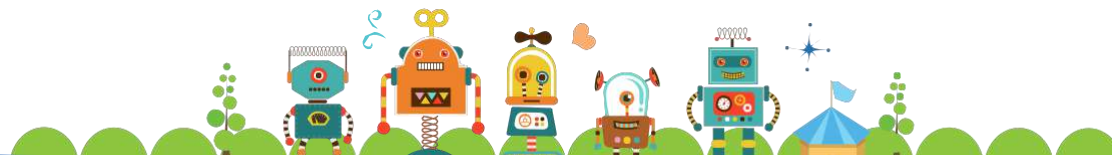
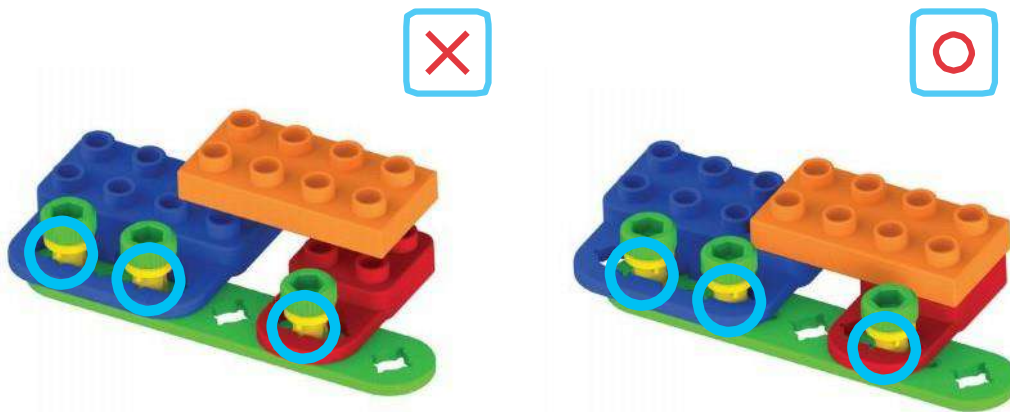



Робот - лыжник



Робот-хоккеист



Рудольф



Снегоочиститель



Чтобы украсить робота,  
установите блочные рамы.



Светлячок



Динозавр



Рино



Музыкальная кукла

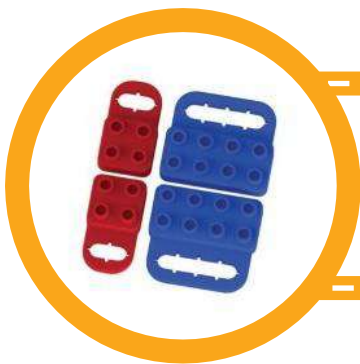

Чтобы украсить робота,  
установите блочные рамы.

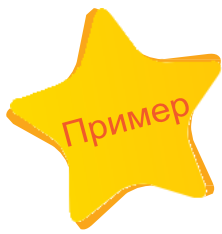

Робот-уборщик



Робот-исследователь



Военный робот



Гуманоид

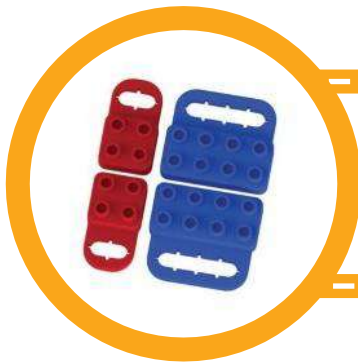

Чтобы украсить робота,  
установите блочные рамы.

---

## Меры предосторожности

1. Запрещается брать части в рот.
2. Эксплуатация, сгибание либо удаление частей с чрезмерным усилием запрещены.
3. Запрещается подставлять руки под элементы подвижных частей.
4. Запрещается бросать элементы и изделия и замахиваться ими в направлении людей.
5. Требуется соблюдение осторожности при касании острых граней частей.
6. Беречь детали от огня
7. Электронные компоненты могут перестать работать при воздействии на них воды
8. Устанавливайте батареи с учетом правильной полярности "+" и "-" в целях предотвращения ее взрыва или протечки
9. Запрещается нагревать или разбирать батареи
10. Запрещается использовать батареи различных типов
11. При попадании жидкости из батареи в глаза, необходимо незамедлительно промыть их большим количеством воды, после чего обратиться за консультацией к врачу в кратчайшие сроки
12. При попадании жидкости из батареи на кожу или одежду, необходимо тщательно вымыть ее чистой водой с мылом. При покраснении кожи обратитесь к врачу
13. Выполнять сборку разрешается под контролем преподавателя или руководством/надзором родителей
14. Так как в наборе содержатся мелкие детали, данный набор не предназначен для использования детьми в возрасте до 3-х лет. Опасность удушья.



### Мир интерактивного программирования

Автор: Jungmi Park, Seunghwan Sin, Youngsuk Choi

Первое издание: 22 февраля 2016 г.

Дата Публ.: 22 февраля 2016 г.

Издательство: RoboRobo Co., LTD.

Авторское право © Roborobo Co., LTD. Все права защищены.

※ Отпечатано в Республике Корея. Настоящее издание защищено авторским правом. Для воспроизведения, хранения в системах автоматического поиска, передачи третьим лицам в любом виде и любыми средствами, включая электронные и механические, копирование, запись и пр., требуется надлежащее разрешение со стороны Издателя. По вопросам получения разрешений обращаться к: RoboRobo Co., LTD.

RoboRobo Bldg., DobongRo 54-6, Mia-Dong, GangBuk-Gu, Сеул, Южная Корея

Тел.: 82-2-909-5050 или 82-1577-5060 Факс: 82-2-917-3511





# Наклейки глаз

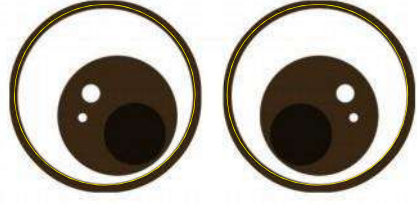
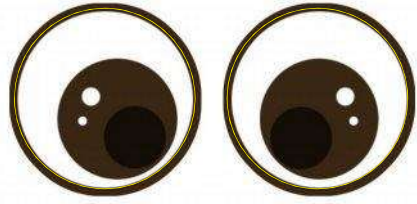
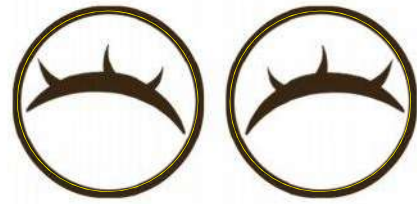
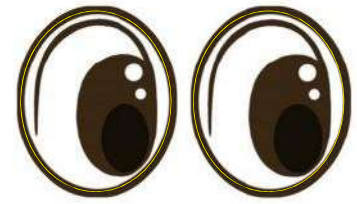
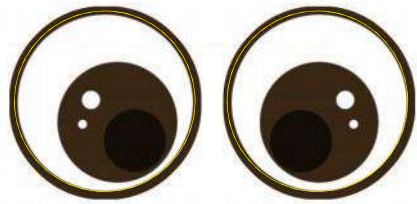
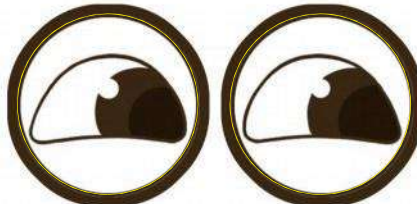
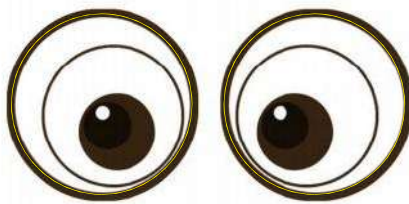
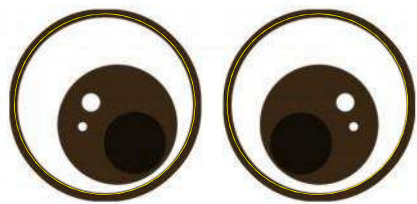
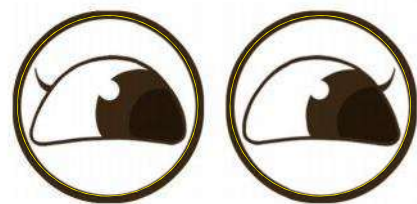
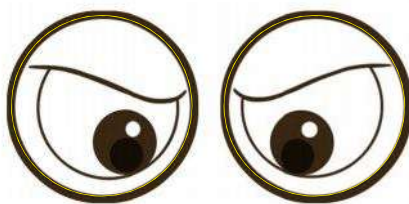
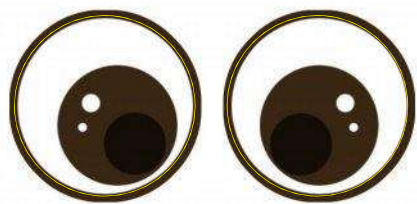
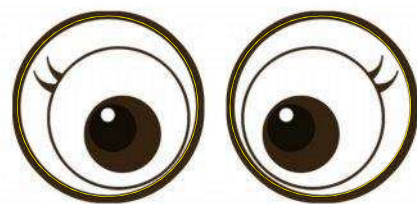
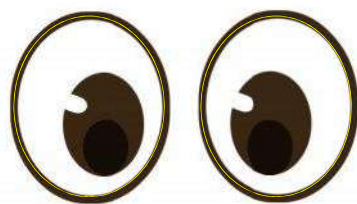
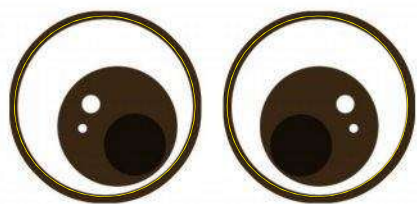

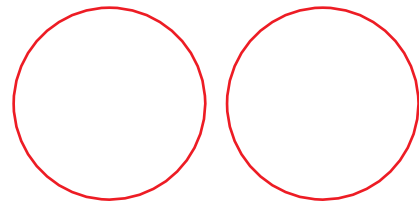
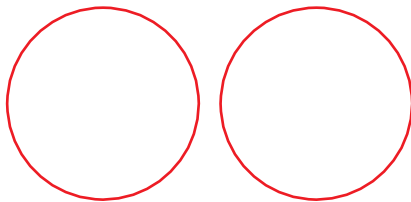
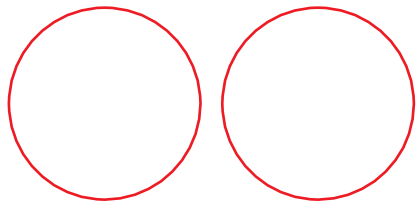
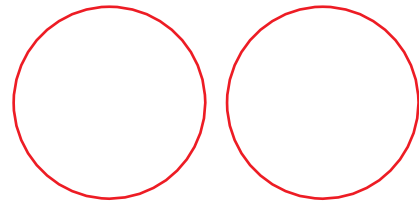
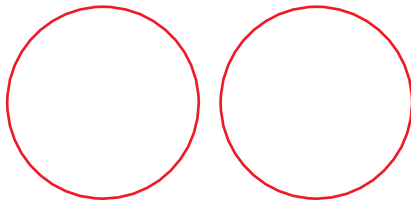
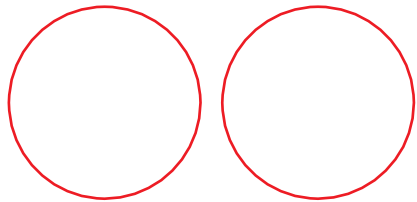
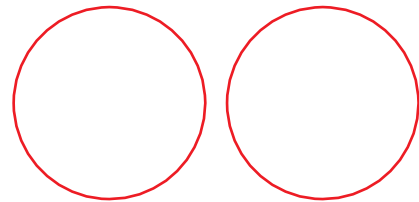
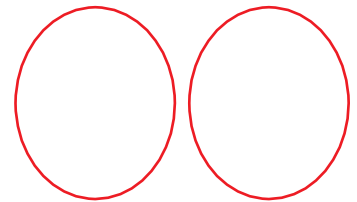
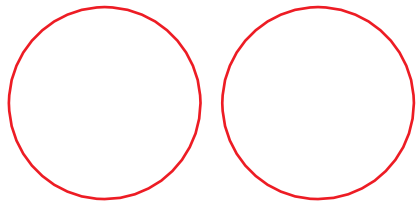
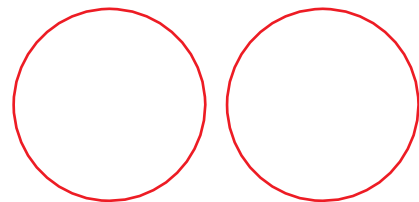
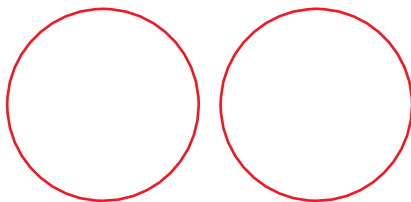
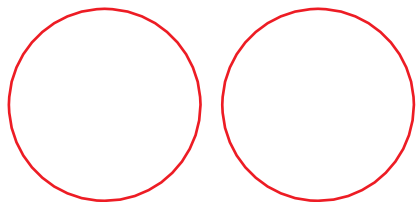
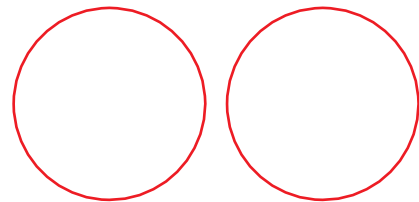
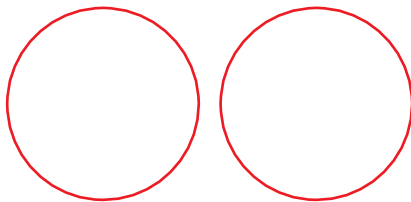
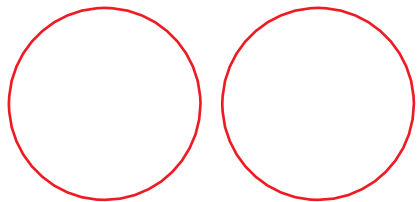
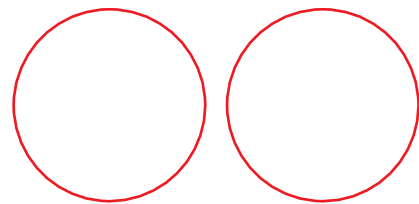
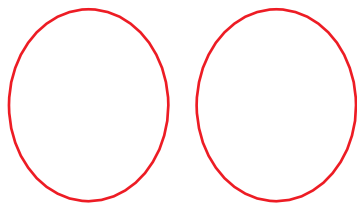
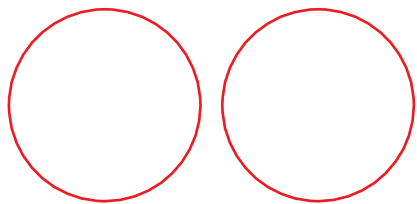

# Перечень частей:



□ рама 2 x 2

□ рама 4 x 4

С-рама x 2

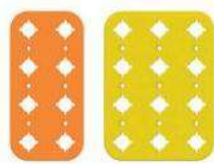

□ рама 8 x 1

□ рама 12 x 2



□ рама 7 x 1

□ рама 10 x 1



└ рама 3 x 2

└ рама 5 x 1



└ рама 4 x 1

└ рама 4 x 2



Ось x 1

□ Рама 5 x 2

□ Рама 6 x 1



Колесо x 1

Маленькое колесо x 1

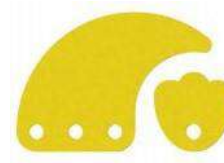

Мягкий рог x 2

Мягкая лапа x 2



LED (B)  
Блок x 3



LED (O)  
Блок x 3



Болт (Y) x 5

Болт (G) x 5



Гайка (Y) x 7

Гайка (G) x 5



Блок мелодий x 3



Блок отсрочки x 2

Длинный болт (B) x 3

Длинный болт (R) x 3

Длинная гайка (B) x 3

Длинная гайка (R) x 3

Поворотная гайка x 2



Блок движений x 2



Блок электромотора x 4



Электромотор x 1



Наклейка глаз x 1

Bluetooth-модуль x 1



## ПРОГРАММИРОВАНИЕ РОБОТА

Мир интерактивного программирования



Робот - лыжник



Робот - хоккеист



Рудольф



Снегоочиститель



Светлячок



Динозавр



Рино

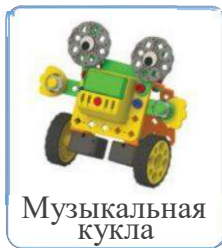

Музыкальная кукла



Робот-уборщик



Исследовательский робот



Военный робот



Гуманоид